



Programming Reference

For printer model:

CT4/ CT4i Series



Copyrights

Any unauthorized reproduction of the contents of this document, in part or whole, is strictly prohibited.

Limitation of Liability

SATO Corporation and its subsidiaries in Japan, the U.S and other countries make no representations or warranties of any kind regarding this material, including, but not limited to, implied warranties of merchantability and fitness for a particular purpose. SATO Corporation shall not be held responsible for errors contained herein or any omissions from this material or for any damages, whether direct, indirect, incidental or consequential, in connection with the furnishing, distribution, performance or use of this material.

Specifications and contents in this document are subject to change without notice.

Trademarks

SATO is a registered trademark of SATO Corporation and its subsidiaries in Japan, the U.S. and other countries. All other trademarks are the property of their respective owners.

Version: GBS-CT4i-01rB-12-03-12PR

©2012 SATO Corporation.

All rights reserved.

Table of Contents

1	Outline	7
2	Initial operation settings.....	8
3	List of font	10
4	How to read the command manual	12
5	Control commands.....	14
5.1	ESC+A Start data transfer.....	14
5.2	ESC+Z End data transfer.....	15
5.3	ESC+Q Number of pages.....	16
5.4	ESC+ID Job ID number	17
5.5	ESC+WK Job name.....	18
5.6	ESC+RK RFID write.....	19
5.7	ESC+RA RFID mode setting.....	22
5.8	ESC+TU UID print.....	23
5.9	ESC+RU UID return	25
6	Define print position.....	26
6.1	ESC+H ESC+H Horizontal print position	26
6.2	ESC+V Vertical print position.....	27
7	Editing commands	28
7.1	ESC+P Character pitch.....	28
7.2	ESC+L Expansion	29
7.3	ESC+PS Proportional pitch.....	30
7.4	ESC+PR Release proportional pitch.....	31
7.5	ESC+% Rotation.....	32
7.6	ESC+F Serial number	33
7.7	ESC+FW Rule / grid print.....	34
7.8	ESC+(Inversed color print.....	35
7.9	ESC+KC Kanji character code	36
7.10	ESC+& Form overlay registration.....	37
7.11	ESC+/ Call form overlay.....	38
7.12	ESC+0 Partial modifications	39
7.13	ESC+WD Label internal copy (partial copy)	40
7.14	ESC+J Journal print.....	42
7.15	ESC+RF Call font & logo	43
7.16	ESC+RZ RFID message print.....	44
8	Font commands	46
8.1	ESC+X20 X20 font	46
8.2	ESC+X21 X21 font	48

8.3	ESC+X22	X22 font	50
8.4	ESC+X23	X23 font	52
8.5	ESC+X24	X24 font	54
8.6	ESC+XU	XU font.....	56
8.7	ESC+XS	XS font.....	58
8.8	ESC+XM	XM font.....	60
8.9	ESC+XB	XB font.....	62
8.10	ESC+XL	XL font	64
8.11	ESC+OA	OCR-A font.....	66
8.12	ESC+OB	OCR-B font.....	68
8.13	ESC+\$	Outline font design.....	70
8.14	ESC+\$=	Outline font printing	71
8.15	ESC+RD	CG font	73
8.16	ESC+K1	16×16 dots horizontally oriented Kanji	76
8.17	ESC+K2	24×24 dots horizontally oriented Kanji	77
8.18	ESC+K3	22×22 dots horizontally oriented Kanji	78
8.19	ESC+K8	16×16 dots horizontally oriented Kanji with 1-byte character	79
8.20	ESC+K9	24×24 dots horizontally oriented Kanji with 1-byte character	80
8.21	ESC+k1	16×16 dots vertically oriented Kanji.....	81
8.22	ESC+k2	24×24 dots vertically oriented Kanji.....	82
8.23	ESC+k3	22×22 dots vertically oriented Kanji.....	83
8.24	ESC+k8	16×16 dots vertically oriented Kanji with 1-byte character.....	84
8.25	ESC+k9	24×24 dots vertical writing Kanji with 1-byte character	85
8.26	ESC+T1	Registration of 16×16 dots external character	86
8.27	ESC+T2	Registration of 24×24 dots external character	88
8.28	ESC+K1 (K2)	Calling horizontally oriented external character	90
8.29	ESC+k1 (k2)	Calling vertically oriented external character.....	91
9	Barcode setting outline.....		92
9.1	ESC+B	Barcode setting (Ratio 1:3).....	95
9.2	ESC+D	Barcode setting (Ratio 1: 2).....	97
9.3	ESC+D~ESC+d	Barcode translation setting	99
9.4	ESC+BD	Barcode setting (Ratio 2: 5).....	100
9.5	ESC+BT	Barcode ratio.....	102
9.6	ESC+BW	Barcode print by specified ratio	103
9.7	ESC+BI	GS1-128(UCC/EAN128).....	105
9.8	ESC+BC	CODE93	108
9.9	ESC+BG	CODE128.....	110
9.10	ESC+BF	UPC add-on barcode (Bookland).....	114
9.11	ESC+BP	Postnet barcode	116
9.12	ESC+BZ	Customer barcode.....	118
9.13	ESC+EU	Symbol.....	120

9.14	ESC+BL	UPC-A barcode (Without translation)	122
9.15	ESC+BL~ESC+d	UPC-A barcode (With translation)	123
9.16	ESC+BM	UPC-A barcode (With translation)	125
10	2D-Code		126
10.1	ESC+2D10	PDF417	126
10.2	ESC+2D12	Micro PDF417	129
10.3	ESC+2D20	MAXI code	132
10.4	ESC+2D30	QR code (Model 2)	134
10.5	ESC+2D31	QR code (Model 1)	138
10.6	ESC+2D32	Micro QR	141
10.7	ESC+2D50	GS1 Data Matrix (ECC200)	166
10.8	ESC+BQ	QR code	168
10.9	ESC+BV	MAXI code	193
10.10	ESC+BK	PDF417	195
10.11	ESC+BX	GS1 Data Matrix	198
10.12	ESC+DC	GS1 Data Matrix (Print data)	199
10.13	ESC+FX	GS1 Data Matrix sequential numbering	200
11	Graphic command		202
11.1	ESC+G	Graphic printing	202
11.2	ESC+GM	BMP file printing	203
11.3	ESC+GP	PCX file printing	204
12	System Command		205
12.1	ESC+CS	Print speed	205
12.2	ESC+#E	Print darkness	206
12.3	ESC+A1	Label size	207
12.4	ESC+A3	Base reference point	209
12.5	ESC+EP	Print end position	210
12.6	ESC+ - (NULL)	Multiple cut	211
12.7	ESC+CT	Cutting interval of label	213
12.8	ESC+NC	Cutting last label	215
12.9	ESC+~A	Cutting interval of label	216
12.10	ESC+~B	Cutting last label	218
12.11	ESC+*	Clear memory	219
12.12	ESC+@	Set printer offline	220
12.13	ESC+C	Reprint	221
12.14	ESC+PG	Registers printer setting in EEPROM (CT Series only)	222
12.15	ESC+PC	Registers printer setting in EEPROM (CT Series only)	225
12.16	ESC+E	Auto-CR line spacing	228
12.17	ESC+LD	User download	229
12.18	ESC+2S	2-color printing area	230

12.19	ESC+PO	Offset	231
12.20	ESC+IG	Change sensor type.....	232
12.21	ESC+PH	Change print method.....	233
12.22	ESC+PM	Paper handling mode.....	234
12.23	ESC+YE	Media selection	235
12.24	ESC+CO	Control code selection.....	236
12.25	ESC+CX	Arbitrary cut	237
12.26	ESC+IK	Media feed/back feed distance.....	238
12.27	ESC+I1	IEEE1284 setting	241
12.28	ESC+I2	Serial interface setting.....	242
12.29	ESC+I3	LAN interface setting.....	243
12.30	ESC+I6	PIN code setting.....	244
12.31	ESC+I7	Authentication mode (Bluetooth).....	245
12.32	ESC+I8	Device name	246
12.33	ESC+BS	Bluetooth setting.....	247
12.34	ESC+W1	IP address setting.....	248
12.35	ESC+W2	Subnet mask setting.....	249
12.36	ESC+W3	Default gateway setting.....	250
12.37	ESC+WI	IP address setting	251
12.38	ESC+WM	RARP setting	252
12.39	ESC+#	Base reference point offset.....	253
12.40	ESC+TW	Option waiting time.....	254
12.41	ESC+TK	Forced Tear off	255
12.42	ESC+TB	Battery mode	256

1 Outline

This document includes the command specifications of CT Series (Overseas models) as follows.

1. CT400
2. CT400-2
3. CT400i

The models listed above are categorized into the following groups.

CT Series	: CT400	(CT400DT/TT, CT410DT/TT, CT420DT/TT)
	: CT400-2	(CT400-2DT/TT, CT410-2DT/TT, CT420-2DT/TT)
	: CT400i	(CT408iDT/TT, CT412iDT/TT, CT424iDT/TT)

There are three types of main PCBs for CT400i as shown below. If the board type is not specified, the common PCB will be used.

Integrated boards :	Integrated board same as CT400-2
Type 1 :	USB, On-board RS-232C
Type 2 :	USB, On-board LAN
Without type spec. :	Using the common PCB

DIP switch is indicated by “DSW” in this document.

2 Initial operation settings

Initial settings are as listed below:

CT400DT/TT

Item	Initial setting
Print speed	4 inch/sec. (100 mm/sec) [Range: 2, 3, 4, 5, 6]
Print darkness range	A (CT400DT), B (CT400TT)
Print darkness	3 [Range: 1, 2, 3, 4, 5]
Base reference point correction	+0
Zero font switch-over	YES
Kanji code setting	JIS
Proportional pitch setting	Proportional pitch

CT410DT/TT

Item	Initial setting
Print speed	4 inch/sec. (100 mm/sec) [Range: 2, 3, 4]
Print darkness range	A (CT410DT), B (CT410TT)
Print darkness	3 [Range: 1, 2, 3, 4, 5]
Base reference point correction	+0
Zero font switch-over	YES
Kanji code setting	JIS
Proportional pitch setting	Proportional pitch

CT420DT/TT

Item	Initial setting
Print speed	2 inch/sec. (50 mm/sec.) [Range: 2, 3]
Print darkness range	A (CT420DT, CT420TT)
Print darkness	3 [Range: 1, 2, 3, 4, 5]
Base reference point correction	+0
Zero font switch-over	YES
Kanji code setting	JIS
Proportional pitch setting	Proportional pitch

CT400-2DT/TT

Item	Initial setting
Print speed	4 inch/sec. (100 mm/sec) [Range: 2, 3, 4, 5, 6]
Print darkness range	A (CT400-2DT), B (CT400-2TT)
Print darkness	3 [Range: 1, 2, 3, 4, 5]
Base reference point correction	+0
Zero font switch-over	YES
Kanji code setting	JIS
Proportional pitch setting	Proportional pitch

CT410-2DT/TT

Item	Initial setting
Print speed	4 inch/sec. (100 mm/sec) [Range: 2, 3, 4]
Print darkness range	A (CT410-2DT), B (CT410-2TT)
Print darkness	3 [Range: 1, 2, 3, 4, 5]
Base reference point correction	+0
Zero font switch-over	YES
Kanji code setting	JIS
Proportional pitch setting	Proportional pitch

CT420-2DT/TT

Item	Initial setting
Print speed	2 inch/sec. (50 mm/sec.) [Range: 2, 3]
Print darkness range	A (CT420-2DT, CT420-2TT)
Print darkness	3 [Range: 1, 2, 3, 4, 5]

Base reference point correction	+0
Zero font switch-over	YES
Kanji code setting	JIS
Proportional pitch setting	Proportional pitch

CT408iDT/TT

Item	Initial setting
Print speed	4 inch/sec. (100 mm/sec) [Range: 2, 3, 4, 5, 6]
Print darkness range	A (CT408iDT), B (CT408iTT)
Print darkness	3 [Range: 1, 2, 3, 4, 5]
Base reference point correction	+0
Zero font switch-over	YES
Kanji code setting	JIS
Proportional pitch setting	Proportional pitch

CT412iDT/TT

Item	Initial setting
Print speed	4 inch/sec. (100 mm/sec) [Range: 2, 3, 4]
Print darkness range	A (CT412iDT), B (CT412iTT)
Print darkness	3 [Range: 1, 2, 3, 4, 5]
Base reference point correction	+0
Zero font switch-over	YES
Kanji code setting	JIS
Proportional pitch setting	Proportional pitch

CT424iDT/TT

Item	Initial setting
Print speed	2 inch/sec. (50 mm/sec.) [Range: 2, 3]
Print darkness range	A (CT424iDT, CT424iTT)
Print darkness	3 [Range: 1, 2, 3, 4, 5]
Base reference point correction	+0
Zero font switch-over	YES
Kanji code setting	JIS
Proportional pitch setting	Proportional pitch

3 List of font

To use internal fonts, specify ESC+ (relevant font command).

Font	Font type	Pitch	Printer
OA (8 dots/mm)	Bitmap [OCR-A font] 15x22 dots	Fixed	All types
OB (8 dots/mm)	Bitmap [OCR-B font] 20x24 dots	Fixed	All types
OA (12 dots/mm) (23.6 dots/mm)	Bitmap [OCR-A font] 22x33 dots	Fixed	All types
OB (12 dots/mm) (23.6 dots/mm)	Bitmap [OCR-B font] 30x36 dots	Fixed	All types
XU	Bitmap [XU font] 5x9 dots	Fixed / Proportional	* 2
XS	Bitmap [XS font] 17x17 dots	Fixed / Proportional	* 2
XM	Bitmap [XM font] 24x24 dots	Fixed / Proportional	* 2
XB	Bitmap [XB font] 48x48 dots	Fixed / Proportional	* 2
XL	Bitmap [XL font] 48x48 dots	Fixed / Proportional	* 2
K1	Bitmap [K1 font] 16x16 dots	Fixed	* 3
K2	Bitmap [K2 font] 24x24 dots	Fixed	* 3
K3	Bitmap [K3 font] 22x22 dots	Fixed	* 3
K8	Bitmap [K8 font] 16x16 dots	Fixed	* 3
K9	Bitmap [K9 font] 24x24 dots	Fixed	* 3
k1	Bitmap [k1 font] 16x16 dots	Fixed	* 3
k2	Bitmap [k2 font] 24x24 dots	Fixed	* 3
k3	Bitmap [k3 font] 22x22 dots	Fixed	* 3
k8	Bitmap [k8 font] 16x16 dots	Fixed	* 3
k9	Bitmap [k9 font] 24x24 dots	Fixed	* 3
\$ (shape) \$= (print)	Outline font specification	Fixed / Proportional	All types
RD	CG font [CG Times]	Fixed / Proportional	* 2
	CG font [CG Triumvirate]	Fixed / Proportional	* 2

* 2 Only available for CT Series.

* 3 For CT Series optional Kanji-supported boards (MEM board with Kanji ROM, Main PCB with Kanji ROM) are needed.

Expanded font

Font can be expanded by a factor of 1 to 12.

Internal bitmap fonts can also be expanded with a factor of 1 to 12.

Example: A font in a size of 5 dots of width and 9 dots of height is expanded by a factor of 3. The resulting font has a width of 15 dots and a height of 27 dots.

The input of expansion factors (height x expansion factor, width x expansion factor) for characters to be printed is done as described below:

Width x expansion factor= width parameter setting value

Height x expansion factor= height parameter setting value

The command <L> decides the expansion of the character. This parameter is set as factor.

Example: If setting the factor to: <L>0304, the character is expanded by a factor of 3 in horizontal direction (width) and a factor of 4 in vertical direction (height)

If a expansion factor is specified, also the pitch between the characters is automatically determined.

Fixed pitch / proportional pitch

At the X20-X24 font, the XU-XL font, the outline font and the CG font it is possible to select between the fixed and the proportional pitch.

Setting and release of the proportional pitch is done as follows: setting: ,PS., release: <PR>.

Depending on the font, the width of the proportional pitch does differ. Katakana is not affected by the proportional pitch. The width of the Kanji characters is narrowed by the proportional pitch.

At the fixed pitch, the character width is according to the relevant font size selected.

Difference between outline font and bitmap font

For the bitmap font the height and the width of the font is predefined. The height of the bitmap font is a little bit larger than the width.

The bitmap font is the largest in the font matrix.

For the font type and size refer to the fontline-up on the previous page.

At the outline font, if setting the height and the width of the font properly, the smooth scaling algorithm of the printer allows a well balanced font. It is also possible to define some style options like a gray scale and a shadow setting.

4 How to read the command manual

2) 7.2 Modification		1)		3)		4)	
Available for		CT400/410/420	CT400-2/410-2/420-2	CT408/412/428			
Font Expansion				ESC+L			
5) →	Hexadecimal	ESC	L	Parameter ← 6)			
7)	code	<1B> ₁₆	<4C> ₁₆	aabb			
	Initial setting	aa=01, bb=01					
8) →	Persistence of the command	When printer is powered-off	Set parameter will not be retained.				
		Validity in a job	Parameter set will be retained until next valid setting				
		Validity after a job	Parameter set will be the initial value for the next job				

9) [Function]
Specifying the print expansion factor.

10) [Format]
<L>aabb
• Parameter
a [Horizontal expansion factor (width)] = validity range : 01 to 12
b [Vertical expansion factor (height)] = validity range : 01 to 12

11) [Coding example] Horizontal expansion factor (width): 4, Vertical expansion factor (height): 3
<A>
<V>100<H>200<P>3<L>**0403**<OA>ABCD
<Q>2
<Z>

12) [Notes]
1. The pitch between the characters is equally enlarged. When setting the inter character pitch <P>, the preset horizontal expansion factor <L> will be valid for the inter character pitches <P> thereafter.
2. If enlarging graphics, put in expansion factor <L> just before the graphic print command.

13) [Tips]
1. When using the expansion function, be careful not to fall out of the printing range. Therefore, select a correct print format.

14) [Valid command]

CT Series

Font	<XU>	<XS>	<XM>	<XB>	<XL>					
	<OA>	<OB>	<RD>	<K1>*1	<K2>*1	<K3>*1	<K8>*1	<K9>*1	<k1>*1	<k2>*1
Modification	<P>	<RF>								
Graphic	<G>	<GM>	<GP>							

*1 Optional Kanji ROM needed.

1) Command identification
[Print], [Print position], [Modification], [Font], [Barcode], [2-D code], [Graphic], [System]

- 2) Command availability / unavailability depending on printer model
 If command is not available: [] will be indicated or the model name is crossed out.

Example) Commands only available for the CT408i/412i/424i as shown below.

Available for				
	CT400/410/420	CT400-2/410-2/420-2	CT408i/412i/424i	

In this document, the description of printer names will be omitted except in special circumstances.

- 3) Command name
- 4) Command code
- 5) Command as Hexadecimal code
- 6) Command describing parameters. () indicates that omission is possible
- 7) Initial command value
- 8) Persistence of the Command
- When printer is powered off
 - (1) Set Parameter will be retained
 - (2) Set parameter will not be retained (Set parameter will not be retained)
 - (3) Command settings will not be retained (Command setting will not be retained)
 - Validity in a job
 - (1) Retained until next valid setting
 - (2) Set parameter will be retained
 - (3) Becomes invalid after execution
 - Valid after a job
 - (1) Set parameter will be the initial value for the next job
 - (2) Set parameter will be retained until next valid setting
 - (3) Becomes invalid after execution
 - (4) Becomes invalid after execution
- 9) Command function outline
- 10) Command, necessary parameter
 <L>aabb indicates the ESC+L (<1B>₁₆<4C>₁₆) command with the parameters aa and bb
- 11) Example for command input
 If putting out a code via RS-232C to a printer connected, the programming will be done in BASIC language:
- ```

10 ESC$=CHR$ (&H1B)
20 OPEN "COM1: 9600, N, 8, 1, RS, BIN" FOR OUTPUT AS #1
30 PRINT #1, ESC$; "A";
40 PRINT #1, ESC$; "V100"; ESC$; "H200";
50 PRINT #1, ESC$; "P3"; ESC$; "L0403";
60 PRINT #1, ESC$; "OAABCD";
70 PRINT #1, ESC$; "Q2";
80 PRINT #1, ESC$; "Z";
90 CLOSE #1
100 END

```
- 12) Explanation of commands and parameters
- 13) Tips when using the command
- 14) Other commands which will be influenced by using the specific command

## 5 Control commands

| 5.1 Control                |                             |                                       |                |
|----------------------------|-----------------------------|---------------------------------------|----------------|
| Available for              |                             |                                       |                |
|                            | CT400/410/420               | CT400-2/410-2/420-2                   | CT408/412/424i |
| <b>Start data transfer</b> |                             | <b>ESC+A</b>                          |                |
| Hexadecimal code           | ESC                         | A                                     | Parameter      |
|                            | <1B> <sub>16</sub>          | <41> <sub>16</sub>                    | None           |
| Initial setting            | None                        |                                       |                |
| Persistence of the command | When printer is powered off | Command setting will not be retained. |                |
|                            | Validity in a job           | Becomes invalid after execution       |                |
|                            | Validity after a job        | Becomes invalid after the job         |                |

### [Function]

Start code. Data transfer initialized.

### [Format]

<A>

### [Coding example]

```
<A>
<V>100<H>200<P>2<L>0202<OA>ABCD
<Q>2
<Z>
```

### [Notes]

1. Initializes item. Command is used always at beginning of an item.
2. Always use data transfer start <A> and data transfer end <Z> as a set.

### [Important]

1. Except for some system commands, all command settings will be set to initial value.
2. If not starting data transfer with <A>, the print will not be executed.

5.2 Control			
Available for	CT400/410/420	CT400-2/410-2/420-2	CT408i/412i/424i
<b>End data transfer</b>		<b>ESC+Z</b>	
Hexadecimal code	ESC <1B> <sub>16</sub>	Z <5A> <sub>16</sub>	Parameter None
Initial setting	None		
Persistence of the command	When printer is powered off	Command settings will not be retained.	
	Validity in a job	Becomes invalid after execution	
	Validity after a job	Becomes invalid after the job	

[Function]

Stop code. Data transfer terminated.

[Format]

<Z>

[Coding example]

<A>  
 <V>100<H>200<P>2<L>0202<OA>ABCD  
 <Q>2  
 <Z>

[Notes]

1. Terminates item. Command is used always at the end of an item.
2. Always use data transfer start <A> and data transfer end <Z> as a set.

[Important]

1. If not ending data transfer with <Z>, the print will not be executed.

5.3 Control			
Available for	CT400/410/420	CT400-2/410-2/420-2	CT408i/412i/424i
<b>Number of pages</b>		<b>ESC+Q</b>	
Hexadecimal code	ESC <1B> <sub>16</sub>	Q <51> <sub>16</sub>	Parameter aaaaaa
Initial setting	aaaaaa=1		
Persistence of the command	When printer is powered off	Set parameter will not be retained	
	Validity in a job	Becomes invalid after execution	
	Validity after a job	Becomes invalid after the job	

[Function]

Defines number of pages to be printed.

[Format]

<Q>aaaaaa

- Parameter  
a [Number of pages] = Valid range : 1 - 999999

[Coding example] 2 pages to be print

```
<A>
<V>100<H>200<P>2<L>0202<OA>ABCD
<Q>2
<Z>
```

[Notes]

1. The data between start data transfer <A> and end data transfer <Z> is regarded as one page. <Q> defines how many pages of the same content shall be printed out.
2. Command is put in before the end data transfer <Z> command.

[Important]

1. Print out of the same information will be done for pages specified. If the appearance of a serial number is set <F>, then this number will be of consecutive order.
2. If specifying a multi-cut <~> or a partial multi-cut <~U> than the defined number of pages will be multiplied by cut number.



5.4 Control			
Available for	CT400/410/420	CT400-2/410-2/420-2	CT408i/412i/424i
<b>Job ID number</b>		<b>ESC+ID</b>	
Hexadecimal code	ESC <1B> <sub>16</sub>	ID <49> <sub>16</sub> <44> <sub>16</sub>	Parameter aa
Initial setting	aa=<20> <sub>16</sub>		
Persistence of the command	When printer is powered off	Set parameter will not be retained	
	Validity in a job	Set parameter will be retained until next valid setting	
	Validity after a job	Becomes invalid after the job	

[Function]

Defines job ID for status return

[Format]

<ID>aa

• Parameter

a [Job ID number] = Valid range : 00 - 99

[Coding example] Job ID number: 01

<A>

**<ID>01**

<V>200<H>100<P>0<\$>B,100,100,6

<\$=>SATOPRINTER

<Q>2

<Z>

[Notes]

1. If using a status return in the transfer protocol, the job ID number can be set in the telegram.
2. The status can be confirmed by putting out a status request (ENQ).
3. This command is set within the item, between start data transfer <A> and end data transfer <Z>.

[Important]

1. Activates when status return transfer protocol is used and status request (ENQ) is received during printing (incl. QTY≠0, offline, error).
2. If status return transfer protocol is used, and status request is received while not printing (QTY=0, start up, no data received), space (20H) will be set and returned as status.
3. If defining a job ID number several times during one item (between start data transfer <A> and end data transfer <Z>), the last definition will be valid.
4. For more details, refer to the "Interface Specifications".

5.5 Control			
Available for	CT400/410/420	CT400-2/410-2/420-2	CT408i/412i/424i
<b>Job name</b>		<b>ESC+WK</b>	
Hexadecimal code	ESC <1B> <sub>16</sub>	WK <57> <sub>16</sub> <4B> <sub>16</sub>	Parameter aaaaaaaaaaaaaaaa
Initial setting	aaaaaaaaaaaaaaaa=<20> <sub>16</sub>		
Persistence of the command	When printer is powered off	Set parameter will not be retained	
	Validity in a job	Set parameter will be retained until next valid setting	
	Validity after a job	Becomes invalid after the job	

[Function]

Defines job name for status return

[Format]

<WK>aaaaaaaaaaaaaaaa

• Parameter

a [Job name] = ASCII code 16 digits, Shift JIS Kanji 8 symbols

[Coding example] Job name: SATO

```
<A>
<WK>SATO
<V>200<H>100<P>0<$>B,100,100,6
<$=>SATOPRINTER
<Q>2
<Z>
```

[Notes]

1. If using the status 4 as transfer protocol, the job name can be set in the telegram.
2. The status can be confirmed by putting out a status request (ENQ).
3. This command is set within the item, between start data transfer <A> and end data transfer <Z>.
4. This command can be used together with Define job ID number <ID>.

[Tips]

1. Activates when status return transfer protocol is used and status request (ENQ) is received during printing (incl. QTY≠0, offline, error).
2. If status return transfer protocol is used, and status request is received while not printing (QTY=0, start up, no data received), space (20H) will be set and returned as status.
3. If defining a job ID name several times during one item (between start data transfer <A> and end data transfer <Z>), the last definition will be valid.
4. For particulars, refer to the [Interface Specification Manual].

5.6 Control			
Available for			
	CT400/410/420	CT400-2/410-2/420-2	CT408i/412i/424i
<b>RFID write</b>		<b>ESC+RK</b>	
Hexadecimal code	ESC <1B> <sub>16</sub>	RK <52> <sub>16</sub> <4B> <sub>16</sub>	Parameter a,(b),Dmmmm,n~n
Initial setting	b=0		
Persistence of the command	When printer is powered off	Set parameter will not be retained	
	Validity in a job	Becomes invalid after execution	
	Validity after a job	Becomes invalid after the job	

[Function]

Specifies data to be written into RFID tag

[Format]

<RK>a,(b),Dmmmm,n~n

•Parameter

a = [Inlet type]: Valid range [0 to 5]

0, 1, 4: Reserved

2: I CODE SLI (Max. write capacity 112 Byte)

3: Tag-it HF-I (Max. write capacity 256 Byte)

5: my-d (Max. write capacity 1000 Byte)

b = [Tolerating RFID tag-error (omissible)]: Valid range [0 to 9]

0: not set (default setting)

1: set

2 to 9: defines number of RFID tag errors to be tolerated

D = [Write-in data identification]

m = [Defines data amount to be written in (Byte)]

Usable character code range when set to ASCII: (00H)~(FFH)

[1 to 112] : I·CODE SLI (when a=2)

[1 to 256] : Tag-it HF-I (when a=3)

[1 to 1024] : my-d (when a=5)

Usable character code range when set to BIN: 0(30H), 1(31H)

[1 to 896] : I·CODE SLI (when a=2)

[1 to 2048] : Tag-it HF-I (when a=3)

[1 to 8192] : my-d (when a=5)

Usable character code range when set to HEX: 0(30H)~9(39H),A(41H)~F(46H)

[1 to 224] : I·CODE SLI (when a=2)

[1 to 512] : Tag-it HF-I (when a=3)

[1 to 2048] : my-d (when a=5)

n = [data written in]

[Coding example 1]

Tag to be used: Tag-it HF-I. Data input: 13 byte, [4912345678904]

(b is omitted)

<A>

<V>50<H>50<BD>3020654912345678904

**<RK>3, D13, 4912345678904**

<Q>2

<Z>

[Coding example 2]

Tag to be used: Tag-it HF-I. Data input: 13 byte, [4912345678904]  
Up to 3 consecutive errors shall be tolerated.

<A>  
<V>50<H>50<BD>3020654912345678904  
**<RK>3, 3, D13, 4912345678904**  
<Q>2  
<Z>

[Coding example 3] (when set to HEX)

Tag to be used: Tag-it HF-I. Data input: 13 byte, [4912345678904]  
(b is omitted)

<A>  
<V>50<H>50<BD>3020654912345678904  
**<RK>3,D13,34393132333435363738393034**  
<Q>2  
<Z>

[Coding example 4] (when set to BIN)

Tag to be used: Tag-it HF-I. Data input: 13 byte, [4912345678904]  
(b is omitted)

<A>  
<V>50<H>50<BD>3020654912345678904  
**<RK>3,D13,0011010000111001001100010011001000110011001101000011010100110110001101110011100000111001001100  
0000110100**  
<Q>2  
<Z>

[Notes]

1. This command is only applicable to printer with the optional RFID kit installed.
2. This command is applicable to following print modes: continuous print, cutter mode (operation 1), dispense mode (operation 1), tear-off mode. In tear-off mode, writing in an RFID tag is possible, but status return operation is not possible.
3. This command does not allow numerous specifications within one item (between start data transfer <A> and end data transfer <Z>).
4. If RFID tag error tolerance is selected, the print will be commenced even if an error has occurred.  
After the print has started, data similar to the one where the error has occurred will be forwarded to every page within the pages specified. The number of pages, defined <Q> will not be reduced.  
If an error tolerance validity range of [2 to 9] is specified, a number of errors according to that specification will be tolerated. If these errors occur in a row, the print will be halted until the LINE key is pushed.  
If an RFID tag error has occurred and the automatic print shall be stopped, refer to the process below:
  - 1) Push the LINE key, if [r] is shown on the 7 segment LED.  
If the print commands in the waiting loop shall be cleared, refer to the process below:  
After having cancelled the print jobs, the printer will return to online mode.
  - 2) Press and release simultaneously the FEED and the LINE key.
  - 3) Press the LINE key until [y] is indicated on the 7 segment LED.
  - 4) Press the FEED key.
5. If having omitted Parameter b, the RFID tag error tolerance will not be available.
6. Serial number or date can not be written on the RFID tag.
7. If using this command to write on a RFID tag, the information sent and the information written on the tag will be compared before print out.
8. For my-d writing operation, the maximum bytes are limited to 232 and 1000 respectively, depending on the type of inlet. If exceeding the bytes specified, an RFID tag error will occur.
9. To change the data input/output format, specify command <RA>2 in the RFID mode setting.
10. For details, refer to the [RFID Kit Option Specifications].

5.7 Control			
Available for	CT400/410/420	CT400-2/410-2/420-2	CT408i/412i/424i
<b>RFID mode setting</b>		<b>ESC+RA</b>	
Hexadecimal code	ESC <1B> <sub>16</sub>	RA <52> <sub>16</sub> <41> <sub>16</sub>	Parameter a
Initial setting	None		
Persistence of the command	When printer is powered off	Parameter set will be automatically saved	
	Validity in a job	Becomes invalid after execution	
	Validity after a job	Becomes invalid after the job	

[Function]

Switch over between normal mode, RFID mode and expanded RFID mode.

[Format]

<RA>a, Bx:b

• Parameter (ASCII format)

a =[Mode selection] : Valid range [0 to 2]

0: Normal mode

1: RFID mode

2: Expanded RFID mode

Expanded parameter when mode is set to 2

Bx: data format, valid range: [0 to 2]

b = 0 : BIN

1 : ASCII (default value when omitted)

2 : HEX

Note when omitting expanded parameter:

If a mode change is involved, the default value is set when omitting expanded parameter. If a mode change is not involved, the value before omitting expanded parameter will be retained.

Coding example

<A>

<RA>2,Bx:1

<Z>

The printer is set to expanded RFID mode with data format ASCII.

[Notes]

1. This command is only applicable to printer with the optional RFID kit installed.
2. When switching over to the RFID mode, the buzzer will give out 3 signal tones, and the printer will stop accepting any commands. Switch off the power supply and restart the printer. This will initialize the RFID mode.
3. If selecting the RFID mode, the sensor setting will not allow any unidentified sensor.
4. If the sensor type is not specified when switching over to RFID mode, it will be set to default value. After restarting the equipment, execute one feed to calibrate the label position.
5. At the LAN / Wireless LAN interface, the data transfer mode will be fixed to ENQ mode, when operating the printer in RFID mode.
6. For details, refer to the [RFID Kit Option Specifications].





[Notes]

1. This command is only applicable to printer with the optional RFID kit installed.
2. Using this command, it is not possible to specify the serial number nor to register the format.
3. Using this command, it is possible to utilize <B>, <D>, <BD>, <X20> - <X24>, and if using 2D codes: <DN>, <DS>. If barcode printing is selected, only CODE39, CODE93, CODE128 can be used. In case of the QR code, numeric character mode / Kanji character mode can not be specified. The Micro QR can not be used.
4. If this command is received during printing, it will be initialized not before the print-out has been finished.
5. This command will be available for the following print modes: continuous mode, cutter mode (operation 1), dispense mode (operation 1).
6. This command does not allow the print of numerous pages. Print each item separately.
7. If the UID data could not be read properly, an error message will be print out.



5.9 Control				
Available for				
	CT400/410/420	CT400-2/410-2/420-2	CT408i/412i/424i	
UID return			ESC+RU	
Hexadecimal code	ESC	RU	Parameter	
	<1B> <sub>16</sub>	<52> <sub>16</sub> <55> <sub>16</sub>	a	
Initial setting	0			

Persistence of the command	When printer is powered off	Command settings will not be retained.
	Validity in a job	Set parameter will be retained until next valid setting
	Validity after a job	Set parameter will be retained until next valid setting

[Function]

Returns the result of writing in a 13.56MHz RFID tag and UID data.

[Format]

<RU>a

• Parameter

- a = UID usage setting
- 0: No status return
  - 1: Write result and UID data will be returned
  - 2: Write result and UID data will be returned only if requested

[Coding example 1]

```
<A>
<RU>1
<RK>1,D13,4912345678904
<Z>
```

[Coding example 2]

```
<A>
<RU>2
<RK>1,D13,4912345678904
<Z>
```

• Status return (UID, when used at tag No. E0123456789ABCDE)

Write-in successful

(UID reading successful)

STX	Status	UID (16 bytes)	ETX
0x02	1(0x31)	E0123456789ABCDE	0x03

Write-in successful

(UID read failure)

STX	Status	UID (16 bytes)	ETX
0x02	1(0x31)	Empty (0x20)	0x03

Write failure

STX	Status	UID (16 bytes)	ETX
0x02	0(0x30)	Empty (0x20)	0x03

[Notes]

1. This command is only applicable to printer with the optional RFID kit installed.
2. If parameter a=1, write result, UID data report will be forwarded after RFID has been read (and before print is commenced).
3. When write-in has been successful but UID reading has failed, a blank space will be forwarded as report.
4. When parameter a=2, upon request (SOH+RU), the write result and UID data edited immediately before will be returned.
5. When parameter a=2, request to return UID after the printer status has been verified (ENQ).

## 6 Define print position

### 6.1 Print position

Available for	CT400/410/420	CT400-2/410-2/420-2	CT408i/412i/424i	
<b>Horizontal print position</b>			<b>ESC+H</b>	
Hexadecimal code	ESC <1B>16	H <48>16	Parameter aaaa	
Initial setting	aaaa=1			

Persistence of the command	When printer is powered off	Command settings will not be retained
	Validity in a job	Set parameter will be retained until next valid setting
	Validity after a job	Set parameter will be the initial value for the next job <A>.

#### [Function]

Specifies horizontal print position in dots from the origin position

#### [Format]

<H>aaaa

- Parameter  
a [Horizontal print position] = Valid range : refer to table below

#### [Coding example] Horizontal print position: 200 dots (from origin)

```
<A>
<V>100<H>200<P>2<L>0202<OA>ABCD
<Q>>2
<Z>
```

#### [Notes]

1. Defines starting position of print for the following: Characters, barcodes, ruled lines, graphics, etc.

#### [Tips]

1. Data outside of the print range (such as characters, barcodes and graphics) will be clipped.

#### [Parameter initial setting and validity range]

Printer	Initial	Range (dots)	Printer	Initial	Range (dots)
CT400DT/TT	1	1 - 832	CT408iDT/TT	1	1 - 832
CT410DT/TT	1	1 - 1248	CT412iDT/TT	1	1 - 1248
CT420DT/TT	1	1 - 2496	CT424iDT/TT	1	1 - 2496
CT400-2DT/TT	1	1 - 832			
CT410-2DT/TT	1	1 - 1248			
CT420-2DT/TT	1	1 - 2496			

#### [Valid commands]

#### CT Series

Font	<XU>	<XS>	<XM>	<XB>	<XL>					
	<OA>	<OB>	<RD>	<\$=>	<K1>*1	<K2>*1	<K3>*1	<K8>*1	<K9>*1	<k1>*1
	<k2>*1	<k3>*1	<k8>*1	<k9>*1						
Barcode	<B>	<BC>	<BG>	<BI>	<BF>	<BP>	<D>	<D><d>	<BD>	<BT>
	<BW>									
2D code	<BK>	<BQ>	<BV>	<BX>						
Modification	<WD>	<FW>	<(>	<RF>						
Graphic	<G>	<GM>	<GP>							

\*1 Optional Kanji ROM is needed.

## 6.2 Print position

Available for	CT400/410/420	CT400-2/410-2/420-2	CT408i/412i/424i
<b>Vertical print position</b>		<b>ESC+V</b>	
Hexadecimal code	ESC <1B> <sub>16</sub>	V <56> <sub>16</sub>	Parameter aaaa
Initial setting	aaaa=1		

Persistence of the command	When printer is powered off	Command settings will not be retained
	Validity in a job	Set parameter will be retained until next valid setting
	Validity after a job	Set parameter will be the initial value for the next job

### [Function]

Specifies vertical print position in dots from the origin position

### [Format]

<V>aaaa

- Parameter

a [Vertical print position] = Valid range : refer to table below

### [Coding example] Vertical print position: 100 dots (from origin)

```
<A>
<V>100<H>200<P>2<L>0202<OA>ABCD
<Q>2
<Z>
```

### [Notes]

- Defines starting position of print for the following: Characters, barcodes, ruled lines, graphics, etc.

### [Parameter, initial setting and validity range]

Printer	Initial	Range (dots)	Printer	Initial	Range (dots)
CT400DT/TT	1	1 - 3200	CT408iDT/TT	1	1 - 3200
CT410DT/TT	1	1 - 4800	CT412iDT/TT	1	1 - 4800
CT420DT/TT	1	1 - 9600	CT424iDT/TT	1	1 - 9600
CT400-2DT/TT	1	1 - 3200			
CT410-2DT/TT	1	1 - 4800			
CT420-2DT/TT	1	1 - 9600			

### [Tips]

- Data outside of the print range (such as characters, barcodes and graphics) will clipped.

### [Valid commands]

#### CT Series

Font	<XU>	<XS>	<XM>	<XB>	<XL>					
	<OA>	<OB>	<RD>	<\$=>	<K1> <sup>*1</sup>	<K2> <sup>*1</sup>	<K3> <sup>*1</sup>	<K8> <sup>*1</sup>	<K9> <sup>*1</sup>	<K1> <sup>*1</sup>
Barcode	<k2> <sup>*1</sup>	<k3> <sup>*1</sup>	<k8> <sup>*1</sup>	<k9> <sup>*1</sup>						
	<B>	<BC>	<BG>	<BI>	<BF>	<BP>	<D>	<D><d>	<BD>	<BT>
2D code	<BW>									
2D code	<BK>	<BQ>	<BV>	<BX>						
Modification	<WD>	<FW>	<I>	<RF>						
Graphic	<G>	<GM>	<GP>							

\*1 Optional Kanji ROM is needed.

## 7 Editing commands

7.1 Modification			
Available for			
	CT400/410/420	CT400-2/410-2/420-2	CT408i/412i/424i
<b>Character pitch</b>		<b>ESC+P</b>	
Hexadecimal code	ESC <1B> <sub>16</sub>	P <50> <sub>16</sub>	Parameter aa
Initial setting	aa=02		

Persistence of the command	When printer is powered off	Set parameter will not be retained
	Validity in a job	Set parameter will be retained until next valid setting
	Validity after a job	Set parameter will be the initial value for the next job

### [Function]

Defines character pitch in dots

### [Format]

<P>aa

- Parameter

a [Inter-character pitch] = Valid range : 00 to 99 dots

### [Coding example] Inter-character pitch: 10

```
<A>
<V>100<H>200<P>10<L>0202<OA>ABCD
<Q>2
<Z>
```

### [Notes]

- The character pitch is the distance between characters, fonts when selecting barcode / font print.
- The character pitch is enlarged according to the expansion factor <L>, if specified.
- Even if automatic line feed is selected <E> and line feedcode [CR] is set, the character pitch remains valid (saved) and the setting does not return to default. Only if Start data transfer <A> is selected, the setting returns to default.
- When setting the character pitch <P> directly before specifying a barcode print, the pitch command for the barcode module becomes valid.  
Applicable barcodes: CODABAR(NW-7), CODE39, Industrial 2of5, Matrix 2of5  
For details, refer to the [9. Barcode settings outline (3) inter-character gap].
- If incorrect values are specified, the settings will return to default.

### [Valid commands]

#### CT Series

Font	<XU>	<XS>	<XM>	<XB>	<XL>					
	<OA>	<OB>	<RD>	<\$>	<K1>*1	<K2>*1	<K3>*1	<K8>*1	<K9>*1	<k1>*1
	<k2>*1	<k3>*1	<k8>*1	<k9>*1						
Modification	<L>	<RF>								
Barcode	<B>	<D>	<D><d>	<BD>	<BT>	<BW>				

\*1 Optional Kanji ROM is needed.

7.2 Modification			
Available for	CT400/410/420	CT400-2/410-2/420-2	CT408i/412i/424i
<b>Expansion</b>		<b>ESC+L</b>	
Hexadecimal code	ESC <1B> <sub>16</sub>	L <4C> <sub>16</sub>	Parameter aabb
Initial setting	aa=01, bb=01		

Persistence of the command	When printer is powered off	Set parameter will not be retained.
	Validity in a job	Set parameter will be retained until next valid setting.
	Validity after a job	Set parameter will be the initial value for the next job.

[Function]

Defines font expansion setting

[Format]

<L>aabb

• Parameter

a [Horizontal expansion factor] = Valid range : 01 to 12  
 b [Vertical expansion factor] = Valid range : 01 to 12

[Coding example]

Horizontal expansion factor: 4 times, Vertical expansion factor: 3 times

<A>  
 <V>100<H>200<P>3<L>0403<OA>ABCD  
 <Q>2  
 <Z>

[Notes]

1. The character pitch is equally enlarged. If setting the character pitch with <P>, the horizontal expansion factor specified with <L> will affect (enlarge) the character pitch.
2. When enlarging graphics, put in the expansion factor <L> just before the graphic print command.

[Tips]

1. Select the format so that the enlarged print does not fall out of the print range.

[Valid commands]

CT Series

Font	<XU>	<XS>	<XM>	<XB>	<XL>					
	<OA>	<OB>	<K1>*1	<K2>*1	<K3>*1	<K8>*1	<K9>*1	<k1>*1	<k2>*1	<k3>*1
	<k8>*1	<k9>*1								
Modification	<P>	<RF>								
Graphics	<G>	<GM>	<GP>							

\*1 Optional Kanji ROM is needed.

7.3 Modification			
Available for	CT400/410/420	CT400-2/410-2/420-2	CT408i/412i/424i
<b>Proportional pitch</b>		<b>ESC+PS</b>	
Hexadecimal code	ESC <1B> <sub>16</sub>	PS <50> <sub>16</sub> <53> <sub>16</sub>	Parameter None
Initial setting	None		
Persistence of the command	When printer is powered off	Command settings will not be retained	
	Validity in a job	Will be retained until next valid setting	
	Validity after a job	Will be retained after the job	

[Function]

Defines proportional pitch

[Format]

<PS>

[Coding example]

<A>

<PS>

<V>100<H>200<P>2<L>0202<XU>ABCD

<Q>2

<Z>

[Notes]

1. When setting proportional pitch <PS>, in case of Katakana the proportional pitch function will be unavailable. When printing Kanji, the pitch will be narrower than if not specified.
2. If the setting is done outside of the possible range, the proportional print will not be performed.
3. The initial settings are as follows: CT Series: proportional pitch <PS>.

[Valid commands]

CT Series

Font	<XU>	<XS>	<XM>	<XB>	<XL>	<RD>	<\$=>			
Modification	<RF>									

7.4 Modification			
Available for	CT400/410/420	CT400-2/410-2/420-2	CT408i/412i/424i
<b>Release proportional pitch</b>		<b>ESC+PR</b>	
Hexadecimal code	ESC <1B> <sub>16</sub>	PR <50> <sub>16</sub> <52> <sub>16</sub>	Parameter None
Initial setting	None		
Persistence of the command	When printer is powered off	Command settings will not be retained	
	Validity in a job	Command set are valid until setting is changed	
	Validity after a job	Will be retained after the job	

[Function]

Releases proportional pitch

[Format]

<PR>

[Coding example]

<A>

<PR>

<V>100<H>200<P>2<L>0202<XM>ABCD

<Q>2

<Z>

[Notes]

1. The initial settings are as follows: CT Series: proportional pitch <PS>.

[Valid commands]

CT Series

Font	<XU>	<XS>	<XM>	<XB>	<XL>	<RD>	<\$=>			
Modification	<RF>									

7.5 Modification				
Available for	CT400/410/420		CT400-2/410-2/420-2	
			CT408i/412i/424i	
<b>Rotation</b>			<b>ESC+%</b>	
Hexadecimal code	ESC <1B> <sub>16</sub>	% <25> <sub>16</sub>	Parameter a	
Initial setting	a=0			

Persistence of the command	When printer is powered off	Set parameter will not be retained
	Validity in a job	Set parameter will be retained until next valid setting
	Validity after a job	Set parameter will be the initial value for the next job

[Function]

Rotates font / barcodes in clock direction

[Format]

<%>a

• Parameter

a [Rotation direction] = 0 : Parallel 1 (0 deg)      1 : Serial 1 (90 deg)  
 2 : Parallel 2 (180 deg)      3 : Serial 2 (270 deg)

[Coding example] Font rotation: Parallel 2, Barcode rotation: Serial 1

```
<A>
<%>2
<V>100<H>400<P>3<L>0403<OA>ABCD
<%>1
<V>400<H>200<BD>103160*123*
<Q>2
<Z>
```

[Notes]

1. The vertical print position and the horizontal print position are absolute values from the origin.
2. If the parameter setting is outside of the specification (non numeric values included), the print will be executed with 0 degree rotation.
3. There is a possibility of blurred print, when printing barcodes in serial 1 or serial 2 mode. Confirm print-out in those cases. Reduce print speed when printing in serial 1 or serial 2 mode.

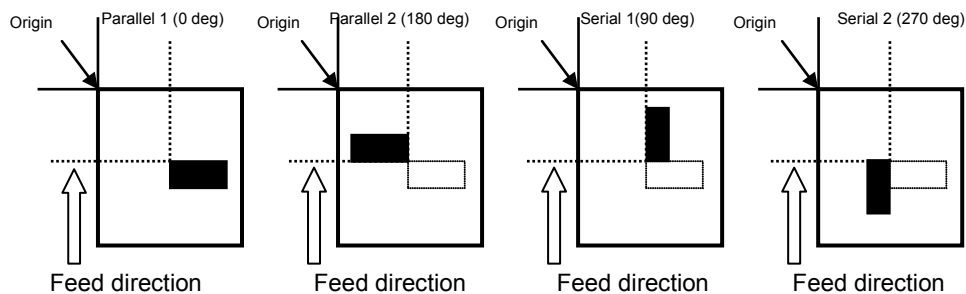

[Valid commands]

CT Series

Font	<XU>	<XS>	<XM>	<XB>	<XL>				
	<OA>	<OB>	<RD>	<\$=>	<K1>*1	<K2>*1	<K3>*1	<K8>*1	<K9>*1
Barcode	<k2>*1	<k3>*1	<k8>*1	<k9>*1					
	<B>	<BC>	<BG>	<BI>	<BF>	<BP>	<D>	<D><d>	<BD>
2D code	<BK>	<BQ>	<BV>	<BX>					
Graphic	<G>	<GM>	<GP>						
System	<E>								
Modification	<RF>								

\*1 Optional Kanji ROM is needed.



7.6 Modification				
Available for	CT400/410/420	CT400-2/410-2/420-2	CT408i/412i/424i	
<b>Serial number</b>			<b>ESC+F</b>	
Hexadecimal code	ESC <1B> <sub>16</sub>	F <46> <sub>16</sub>	Parameter Aaaabcccc(,dd,ee,f)	
Initial setting	None			
Persistence of the command	When printer is powered off	Set parameter will not be retained		
	Validity in a job	Becomes invalid after execution		
	Validity after a job	Becomes invalid after the job		

[Function]

Sets before the font / barcode data is specified. Assigns the specified data a serial number (consecutive) and adds it to the print.

[Format]

<F>aaaabcccc (,dd,ee,f)

• Parameter

a	[Print copies]	=	Valid range	:	1 to 9999	
b	[Increase/Decrease]	=	+	:	Increase	
			-	:	Decrease	
c	[Starting number]	=	Valid range	:	1 to 9999	
d	[Range of numeration (digits)]	=	Valid range	:	1 to 99	when omitted: 8
e	[Minimum downward count (digits)]	=	Valid range	:	0 to 99	when omitted: 0
f	[Decimal/ hexadecimal numeration]	=	Valid range	:	0 to 99	when omitted: 0
			0	:	Decimal	when omitted: 0
			1	:	Hexadecimal	

[Coding example] Pages of print: 1, Increase/Decrease: +, Starting number: 1,  
Range of numeration: 5 digits, Minimum downward count: 0

```
<A>
<V>100<H>100<P>2<L>0202
<F>1+1.5.0<OA>10000
<Q>2
<Z>
```

[Notes]

- Up to 8 serial numbers can be specified for one format.
- The inverse color setting <(> is not available for this function.
- The automatic line feed <E> is not available.
- In order to perform serial number printing, it is required to print font or barcode.
- It is required to align the valid numeration of serial number to the numeration of font or specified command of barcode. If the serial number has more digits, the serial number will not be printed.

[Valid commands]

CT Series

Font	<XU>	<XS>	<XM>	<XB>	<XL>					
	<OA>	<OB>								
Barcode	<B>	<BC>	<BG>	<BI>	<BF>	<BP>	<D>	<D><d>	<BD>	<BT>
	<BW>	<BL>	<BM>							

## 7.7 Modification

Available for	CT400/410/420	CT400-2/410-2/420-2	CT408i/412i/424i
<b>Rule / grid print</b>		<b>ESC+FW</b>	
Hexadecimal code	ESC <1B> <sub>16</sub>	FW <46> <sub>16</sub> <57> <sub>16</sub>	Parameter Rule aabcccc Grid aabbVccccHdddd
Initial setting	None		

Persistence of the command	When printer is powered off	Set parameter will not be retained
	Valid in a job	Becomes invalid after execution
	Validity after a job	Becomes invalid after the job

### [Function]

Prints rule / grid

### [Format]

<FW>aabcccc

Rule print

#### • Parameter

a	[Line width]	=	Valid range	:	02 to 99 dots
b	[Horizontal / vertical setting]	=	H	:	Horizontal
			V	:	Vertical
c	[Length]	=	Valid range	:	Refer to table below

<FW>aabbVccccHdddd

Grid print

#### • Parameter

a	[Vertical line width]	=	Valid range	:	02 to 99 dots
b	[Horizontal line width]	=	Valid range	:	02 to 99 dots
c	[Vertical line length]	=	Valid range	:	Refer to table below
d	[Horizontal line length]	=	Valid range	:	Refer to table below

[Coding example] Ruled line: Line width: 4, Horizontal setting, Length: 400  
Grid: V. line width: 8, H. line width: 8, V. line length: 300, H. line length: 400

```
<A>
<V>100<H>200<FW>04H400
<V>300<H>200<FW>0808V300H400
<Q>2
<Z>
```

### [Notes]

1. If the print start position is outside of the printable area, it will not print due to a command error.

### [Valid range]

Printer	Range: Horizontal line length (dots)	Range: Vertical line length (dots)
CT400DT/TT	1 - 832	1 - 3200
CT410DT/TT	1 - 1248	1 - 4800
CT420DT/TT	1 - 2496	1 - 9600
CT400-2DT/TT	1 - 832	1 - 3200
CT410-2DT/TT	1 - 1248	1 - 4800
CT420-2DT/TT	1 - 2496	1 - 9600
CT408iDT/TT	1 - 832	1 - 3200
CT412iDT/TT	1 - 1248	1 - 4800
CT424iDT/TT	1 - 2496	1 - 9600

7.8 Modification			
Available for	CT400/410/420	CT400-2/410-2/420-2	CT408i/412i/424i
<b>Inversed color print</b>		<b>ESC+(</b>	
Hexadecimal code	ESC <1B> <sub>16</sub>	( <28> <sub>16</sub>	Parameter aaaa,bbbb
Initial setting	None		
Persistence of the command	When printer is powered off	Set parameter will not be retained	
	Validity in a job	Becomes invalid after execution	
	Validity after a job	Becomes invalid after the job	

[Function]

Sets reversed color print (black/white)

[Format]

<(>aaaa,bbbb

• Parameter

- a [Valid range in horizontal direction] = Valid range : Refer to table below
- b [Valid range in vertical direction] = Valid range : Refer to table below

[Coding example] Valid range in horizontal direction: 200, Valid range in vertical direction: 70

```
<A>
<V>50<H>50<P>2<L>0202<OA>ABC
<V>50<H>50<(>200,70
<Q>2
<Z>
```

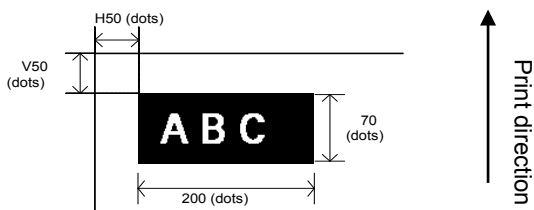

[Notes]

- The horizontal and vertical print positions <H>, <V> are set before the inversed printing color setting <(>.
- If the print start position is outside of the printable area, it will not print due to a command error.

[Tips]

- Specify setting so that the black print does not exceed 30% of the label.

[Valid range]

Printer	Range: Horizontal length (dots)	Range: Vertical length (dots)
CT400DT/TT	1 - 832	1 - 3200
CT410DT/TT	1 - 1248	1 - 4800
CT420DT/TT	1 - 2496	1 - 9600
CT400-2DT/TT	1 - 832	1 - 3200
CT410-2DT/TT	1 - 1248	1 - 4800
CT420-2DT/TT	1 - 2496	1 - 9600
CT408iDT/TT	1 - 832	1 - 3200
CT412iDT/TT	1 - 1248	1 - 4800
CT424iDT/TT	1 - 2496	1 - 9600



7.10 Modification			
Available for	CT400/410/420	CT400-2/410-2/420-2	CT408i/412i/424i
<b>Form overlay registration</b>		<b>ESC+&amp;</b>	
Hexadecimal code	ESC <1B> <sub>16</sub>	& <26> <sub>16</sub>	Parameter None
Initial setting	None		

Persistence of the command	When printer is powered off	Command settings will not be retained
	Valid range	Will be retained until next valid setting
	Validity after a job	Will be retained until next valid setting

[Function]

Registers form-overlay

[Format]

<&>

[Coding example]

```
<A>
<V>100<H>50<FW>1010V800H750
<V>100<H>50<FW>0505V760H710
<V>150<H>100<OA>MODEL
<&>
<Z>
```

[Notes]

1. After having registered a specified form overlay <&>, this format can be loaded by </> and applied to any print data.
2. The form overlay register function is set at the end of a format specification. The form overlay is valid over the entire print range.
3. Only one format can be registered.
4. If willing to change the format, first clear the form overlay with <\*&> before setting the form overlay another time.
5. The registered format can be loaded with </>.
6. If selecting a label size according to <A1> the registered form overlay will be expanded.

[Valid commands]

CT Series

Print position	<V>	<H>								
Modification	<WD>	<FW>	<(>	<RF>						
Font	<XU>	<XS>	<XM>	<XB>	<XL>					
	<OA>	<OB>	<RD>	<\$=>	<K1>*1	<K2>*1	<K3>*1	<K8>*1	<K9>*1	<k1>*1
Barcode	<k2>*1	<k3>*1	<k8>*1	<k9>*1						
	<B>	<BC>	<BG>	<BI>	<BF>	<BP>	<D>	<D><d>	<BD>	<BT>
	<BW>									
2D code	<BK>	<BQ>	<BV>	<BX>						
Graphic	<G>	<GM>	<GP>							

\*1 Optional Kanji ROM is needed.

7.11 Modification			
Available for	CT400/410/420	CT400-2/410-2/420-2	CT408i/412i/424i
<b>Call form overlay</b>		<b>ESC+/ /</b>	
Hexadecimal code	ESC <1B> <sub>16</sub>	/ <2F> <sub>16</sub>	Parameter None
Initial setting	None		
Persistence of the command	When printer is powered off	Command settings will not be retained	
	Validity in a job	Will be retained until next valid setting	
	Validity after a job	Will be retained until next valid setting	

[Function]

Specifies to invoke form overlay

[Format]

</>

[Coding example]

```
<A>
</>
<V>200<H>100<P>0<$>B,100,100,6
<$>SATOPRINTER
<V>720<H>150102100*95000012345*
<Q>2
<Z>
```

[Notes]

1. This command invokes the form-overlay, saved by the form-overlay registration <&> command.
2. If detecting this command in a normal print data, this data will be combined with a graphic saved in the form overlay for printing out.

7.12 Modification			
Available for	CT400/410/420	CT400-2/410-2/420-2	CT408i/412i/424i
<b>Partial modifications</b>		<b>ESC+0</b>	
Hexadecimal code	ESC <1B> <sub>16</sub>	0 <30> <sub>16</sub>	Parameter None
Initial setting	None		
Persistence of the command	When printer is powered off	Command settings will not be retained	
	Valid range	Becomes invalid after execution	
	Validity after a job	Becomes invalid after the job	

[Function]

Specifies to edit the latest printed data partially

[Format]

<0>

[Coding example] Print data [DEF] is modified into [123]

```

<A>
<V>100<H>200<P>2<L>0202<XM>ABC
<V>200<H>200<P>2<L>0202<XM>DEF
<Q>1
<Z>
} 1st data

<A>
<0>
<V>200<H>200<P>2<L>0202<XM>123
<Q>1
<Z>
} 2nd data

```

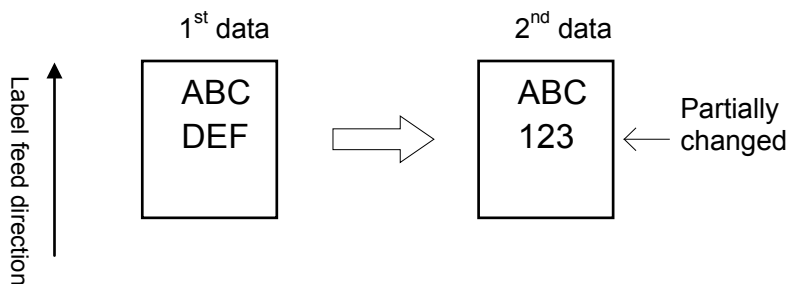

[Notes]

1. Used when data of print does only differ partially from latest printed data.
2. Invoke the last printed data with the command <0> to edit this data partially and to print out. Specify the data to be changed and send a new data to be replaced with it.
3. The original data (1<sup>st</sup> data shown above) will be cleared.
4. If the rotation command <%> is specified for the old data, this rotation will also be maintained for the new data.
5. Use the partial modifications command <0> with fixed pitch, same font and same number of digits.

7.13 Modification			
Available for	CT400/410/420	CT400-2/410-2/420-2	CT408i/412i/424i
Label internal copy (partial copy)		ESC+WD	
Hexadecimal code	ESC <1B> <sub>16</sub>	WD <57> <sub>16</sub> <44> <sub>16</sub>	Parameter VaaaaHbbbbYccccXdddd
Initial setting	None		
Persistence of the command	When printer is powered off	Set parameter will not be retained	
	Validity in a job	Becomes invalid after execution	
	Validity after a job	Becomes invalid after the job	

[Function]

Copies data from one place to an other destination.

[Format]

<WD>VaaaaHbbbbYccccXdddd

• Parameter

a	[Vertical position of origin]	=	Valid range	:	Refer to the below
b	[Horizontal position of origin]	=	Valid range	:	Refer to the below
c	[Vertical dot number of origin]	=	Valid range	:	Refer to the below
d	[Horizontal dot number of origin]	=	Valid range	:	Refer to the below

[Coding example] Vertical position of origin: 50, Horizontal position of origin: 50, Vertical dot number of origin: 200, Horizontal dot number of origin: 400

```
<A>
<V>50<H>50<P>2<L>0202<XU>ABCD
<V>300<H>100<WD>V50H50Y200X400
<Q>2
<Z>
```

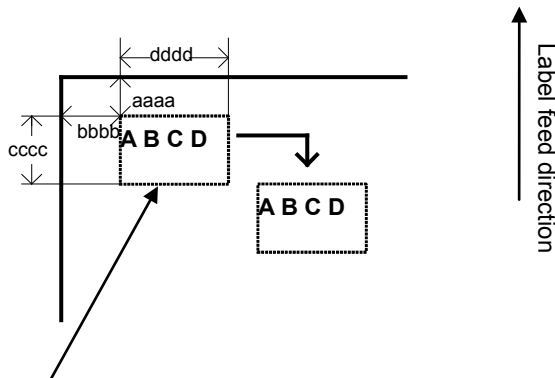

The dotted line indicates the copy range.  
The actual print is limited to ABCD.

[Notes]

1. Specify the print position by vertical position <V> and horizontal position <H> before performing data copy <WD>.
2. Do not place the print position within the range of the origin.
3. If the print start position of copy area is outside of the printable area, it will not print due to a command error.



[Valid range]

Printer	Valid range (dots)	
	Horizontal position of origin Horizontal dot number	Vertical position of origin Vertical dot number
CT400DT/TT	1 - 832	1 - 3200
CT410DT/TT	1 - 1248	1 - 4800
CT420DT/TT	1 - 2496	1 - 9600
CT400-2DT/TT	1 - 832	1 - 3200
CT410-2DT/TT	1 - 1248	1 - 4800
CT420-2DT/TT	1 - 2496	1 - 9600
CT408iDT/TT	1 - 832	1 - 3200
CT412iDT/TT	1 - 1248	1 - 4800
CT424iDT/TT	1 - 2496	1 - 9600

7.14 Modification			
Available for	CT400/410/420	CT400-2/410-2/420-2	CT408i/412i/424i
<b>Journal print</b>		<b>ESC+J</b>	
Hexadecimal code	ESC <1B> <sub>16</sub>	J <4A> <sub>16</sub>	Parameter a - a+CR<0D> <sub>16</sub>
Initial setting	None		
Persistence of the command	When printer is powered off	Set parameter will not be retained	
	Validity in a job	Becomes invalid after execution	
	Validity after a job	Becomes invalid after the job	

[Function]

Specifies journal print

[Format]

<J>a-a+CR

• Parameter

a [Column of journal print] = Print data  
CR [Control code (0DH)]

[Coding example]

<A>  
<J>  
ABCD+CR  
EFGH+CR  
<Z>

[Notes]

1. Journal print is executed from 2dots vertical position and 2 dots horizontal position.
2. Inter character pitch is fixed to 2 dots. The inter-line pitch is fixed to 16 dots.
3. The font type is set to the following: XS-font, factor 2x2.
4. Setting the journal print command cancels all other commands, except from the re-issuing command <C> and the inversed color printing command <(>.

7.15 Modification			
Available for	CT400/410/420	CT400-2/410-2/420-2	CT408i/412i/424i
<b>Call font &amp; logo</b>		<b>ESC+RF</b>	
Hexadecimal code	ESC <1B> <sub>16</sub>	RF <52> <sub>16</sub> <46> <sub>16</sub>	Parameter aabbbb,n - n
Initial setting	aa=01, bbbb=1		
Persistence of the command	When printer is powered off	Set parameter will not be retained	
	Validity in a job	Becomes invalid after execution	
	Validity after a job	Becomes invalid after the job	

[Function]

Invokes and print out fonts and logos downloaded by a specific tool

[Format]

<RF>aabbbb,n - n

• Parameter

a [Font ID Number] = Valid range : 01 to 99  
 b [Digits to be printed] = Valid range : 1 to 9999  
 n [Print data]

[Coding example 1] When calling the font with this command and printing 1 byte characters of "AB". [Font ID No.: 01, Digits: 4]  
 (Unicode is A: <0041><sub>16</sub>, B: <0042><sub>16</sub>)

```
<A>
<PS>
<V>100<H>100<L>0101
<RF>010004,<0041>16<0042>16
<Z>
```

[Coding example 2] When calling the logo with this command and printing [Font ID No.: 02, Digits: 2]

```
<A>
<V>100<H>100<L>0101<RF>020002,<826B>16
<Z>
```

[Notes]

1. For the CT Series, put in the Unicode value for print data.
2. For the CT Series, when calling and printing logos, put in [Digits: 0002], [Print data: <826B><sub>16</sub>]. (<826B><sub>16</sub> is the value of the L Shift JIS code)

7.16 Modification			
Available for			
	CT400/410/420	CT400-2/410-2/420-2	CT408i/412i/424i
<b>RFID message print</b>		<b>ESC+RZ</b>	
Hexadecimal code	ESC	RZ	Parameter
	<1B> <sub>16</sub>	<52> <sub>16</sub> <5A> <sub>16</sub>	a
Initial setting	a=0		
Persistence of the command	When printer is powered off	Set parameter will not be retained	
	Valid range	Becomes invalid after execution	
	Validity after a job	Becomes invalid after the job	

[Function]

Specifies the information to be printed onto tag, when RFID tag error has occurred

[Format]

<RZ>a

• Parameter

a [Print of slash] = 0: OFF  
1: ON

[Coding example] Printing a message of [No RFID Label] (X22 character) with a slash onto a 90x60mm label.  
(When head density is 8 dots/mm)

<A>  
<A1>07200480  
<V>80<H>80<L>0101<X22>, No RFID Label  
<RZ>1  
<Z>

[Printing example]

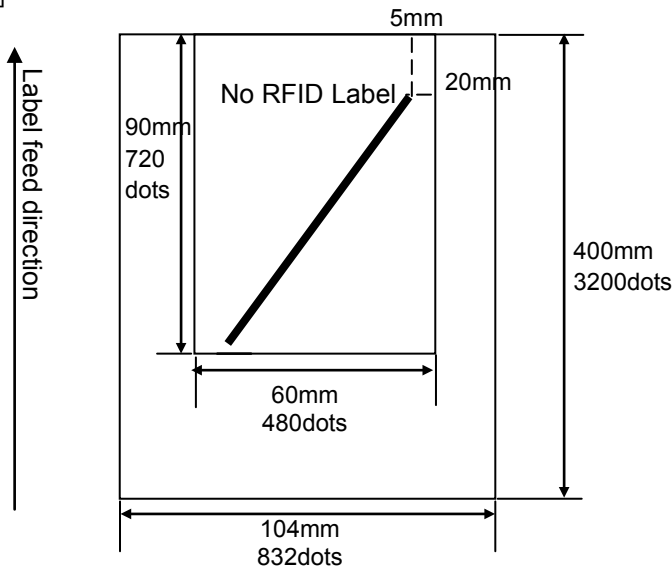

[Notes]

1. This command is only valid for the printer with an optional RFID kit installed.
2. Always specify the label size <A1>. If not having defined label size, or having defined incorrect label size, the message might not be correctly transferred to the label.
3. When slash and message are not specified, an error message will not be printed on the label.
4. Not only fonts but also graphics <G> and BMP files <GM> can be printed as error message.
5. The RFID error message and normal printing data can not be registered in one and the same item. Use different items for those purposes.
6. Put in the RFID message print settings <RZ> directly before the end data transfer <Z> command.
7. If having set command for number of pages <Q> in the same item as this command, <Q> will be disregarded.
8. If this command is not set, in case of a RFID error, [RFID TAG ERROR] and a slash will be printed out (initial setting). The print position will be automatically adjusted to the label size set for normal printing.
9. For details on RFID operation, refer to [RFID Kit Option Specifications].

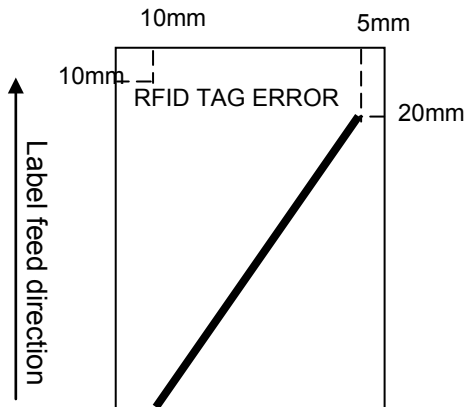

[Valid commands]

CT Series

Print position	<V>	<H>								
Font	<XU>	<XS>	<XM>	<XB>	<XL>					
	<OA>	<OB>	<RD>	<\$=>	<K1>*1	<K2>*1	<K3>*1	<K8>*1	<K9>*1	<K1>*1
Barcode	<k2>*1	<k3>*1	<k8>*1	<k9>*1						
	<B>	<BC>	<BG>	<BI>	<BF>	<BP>	<D>	<D><d>	<BD>	<BT>
	<BW>									
2D code	<BK>	<BQ>	<BV>	<BX>						
Modification	<WD>	<FW>	<(>							
Graphic	<G>	<GM>	<GP>							
System	<A1>									

\*1 Optional Kanji ROM is needed.

## 8 Font commands

8.1 Font			
Available for	CT400/416/420	CT400-2/416-2/420-2	CT408/412/424
<b>X20 font (Basic size 5x9 dots)</b>		<b>ESC+X20</b>	
Hexadecimal code	ESC <1B> <sub>16</sub>	X20 <58> <sub>16</sub> <32> <sub>16</sub> <30> <sub>16</sub>	Parameter ,n - n
Initial setting	None		

Persistence of the command	When printer is powered off	Set parameter will not be retained
	Validity in a job	Becomes invalid after execution
	Validity after a job	Becomes invalid after the job

### [Function]

Font with the basic size of: width 5 dots, height 9 dots is specified.

### [Format]

<X20>,n - n

- Parameter

n [Print data] = Data

### [Coding example]

```
<A>
<V>100<H>200<P>2<L>0304<X20>.ABCDE
<Q>2
<Z>
```

### [Notes]

1. The X20 font allows the setting of a fixed pitch or the setting of a proportional pitch.

### [Valid commands]

Print position	<V>	<H>								
Modification	<P>	<L>	<%>	<F>	<&>	</>	<O>	<WD>	<PS>	<PR>
Barcode	<D><d>									

## X20 font character set

Basic size is 5 x 9 dots (width x height)

	0	1	2	3	4	5	6	7	8	9	A	B	C	D	E	F
0			0	@	P		p				-	ヲ	ヰ			
1		!	1	A	Q	a	q				ア	チ	ム			
2		"	2	B	R	b	r				イ	ツ	ヌ			
3		#	3	C	S	c	s				ウ	テ	モ			
4		\$	4	D	T	d	t				エ	ト	セ			
5		%	5	E	U	e	u			.	オ	フ	ユ			
6		&	6	F	V	f	v			ヨ	カ	ニ	ヨ			
7		'	7	G	W	g	w				キ	ヌ	ラ			
8		<	8	H	X	h	x				ク	ネ	リ			
9		>	9	I	Y	i	y				ケ	ノ	ル			
A		*	:	J	Z	j	z				コ	ハ	レ			
B		+	;	K	φ	k	-				サ	ヒ	ロ			
C		,	<	L	¥	l	-				シ	フ	フ			
D		-	=	M		m					ス	ヘ	ン			
E		.	>	N		n					セ	ホ	ン			
F		/	?	O		o					ソ	マ	◇			

The print sample shown above is issued with a head density of 8 dots/mm and a expansion factor of 3 (vertical/horizontal).

8.2 Font			
Available for	CT400/410/420	CT400-2/410-2/420-2	CT408/412/424i
<b>X21 font (Basic size 17x17 dots)</b>		<b>ESC+X21</b>	
Hexadecimal code	ESC <1B> <sub>16</sub>	X21 <58> <sub>16</sub> <32> <sub>16</sub> <31> <sub>16</sub>	Parameter ,n - n
Initial setting	None		
Persistence of the command	When printer is powered off	Set parameter will not be retained	
	Validity in a job	Becomes invalid after execution	
	Validity after a job	Becomes invalid after the job	

[Function]

Font with the basic size of: width 17 dots, height 17 dots is specified.

[Format]

<X21>,n - n

• Parameter

n [Print data] = Data

[Coding example]

<A>  
 <V>100<H>200<P>2<L>0304<X21>,ABCDE  
 <Q>2  
 <Z>

[Notes]

1. The X21 font allows the setting of a fixed pitch or the setting of a proportional pitch.

[Valid commands]

Print position	<V>	<H>								
Modification	<P>	<L>	<%>	<PS>	<PR>	<F>	<&>	</>	<O>	<WD>
Barcode	<D><d>									



## X21 font character set

Basic size is 17 x 17 dots (width x height)

	0	1	2	3	4	5	6	7	8	9	A	B	C	D	E	F
0			0	@	P	'	p				一	夕	ミ			
1		!	1	A	Q	a	q			.	ア	チ	ム			
2		"	2	B	R	b	r			「	イ	ツ	メ			
3		#	3	C	S	c	s			」	ウ	テ	モ			
4		\$	4	D	T	d	t			、	エ	ト	ヤ			
5		%	5	E	U	e	u			・	オ	ナ	ユ			
6		&	6	F	V	f	v			ヲ	カ	ニ	ヨ			
7		'	7	G	W	g	w			ア	キ	ヌ	ラ			
8		(	8	H	X	h	x			イ	ク	ネ	リ			
9		)	9	I	Y	i	y			ウ	ケ	ノ	ル			
A		*	:	J	Z	j	z			エ	コ	ハ	レ			
B		+	;	K	[	k	{			オ	サ	ヒ	ロ			
C		,	<	L	¥	l	!			ヤ	シ	フ	ワ			
D		-	=	M	]	m	}			ユ	ス	ヘ	ソ			
E		.	>	N	^	n	~			ヨ	セ	ホ	°			
F		/	?	O	_	o				ツ	ソ	マ	°			

The print sample shown above is issued with a head density of 8 dots/mm and a expansion factor of 2 (vertical/horizontal).

8.3 Font			
Available for	CT400/410/420	CT400-2/410-2/420-2	CT408/412/424i
<b>X22 font (Basic size 24x24 dots)</b>		<b>ESC+X22</b>	
Hexadecimal code	ESC <1B> <sub>16</sub>	X22 <58> <sub>16</sub> <32> <sub>16</sub> <32> <sub>16</sub>	Parameter ,n - n
Initial setting	None		
Persistence of the command	When printer is powered off	Set parameter will not be retained	
	Validity in a job	Becomes invalid after execution	
	Validity after a job	Becomes invalid after the job	

[Function]

Font with the basic size of: width 24 dots, height 24 dots is specified.

[Format]

<X22>,n - n

• Parameter

n [Print data] = Data

[Coding example]

<A>  
 <V>100<H>200<P>2<L>0304<X22>,ABCDE  
 <Q>2  
 <Z>

[Notes]

1. The X22 font allows the setting of a fixed pitch or the setting of a proportional pitch.

[Valid commands]

Print position	<V>	<H>								
Modification	<P>	<L>	<%>	<PS>	<PR>	<F>	<&>	</>	<O>	<WD>
Barcode	<D><d>									

## X22 font character set

Basic size is 24 x 24 dots (width x height)

	0	1	2	3	4	5	6	7	8	9	A	B	C	D	E	F
0				0	@	P	`	p				—	夕	ミ		
1			!	1	A	Q	a	q			.	ア	チ	ム		
2			”	2	B	R	b	r			「	イ	ツ	メ		
3			#	3	C	S	c	s			」	ウ	テ	モ		
4			\$	4	D	T	d	t			,	エ	ト	ヤ		
5			%	5	E	U	e	u			・	オ	ナ	ユ		
6			&	6	F	V	f	v			ヲ	カ	ニ	ヨ		
7			'	7	G	W	g	w			ア	キ	ヌ	ラ		
8			(	8	H	X	h	x			イ	ク	ネ	リ		
9			)	9	I	Y	i	y			ウ	ケ	ノ	ル		
A			*	:	J	Z	j	z			エ	コ	ハ	レ		
B			+	;	K	[	k	{			オ	サ	ヒ	ロ		
C			,	<	L	¥	l	!			ヤ	シ	フ	ワ		
D			-	=	M	]	m	}			ユ	ス	ヘ	ン		
E			.	>	N	^	n	~			ヨ	セ	ホ	´		
F			/	?	O	_	o				ツ	ソ	マ	°		

The print sample shown above is issued with a head density of 8 dots/mm and a expansion factor of 1 (vertical/horizontal).

8.4 Font			
Available for	CT400/410/420	CT400-2/410-2/420-2	CT408/412/424i
<b>X23 font (Basic size 48x48 dots)</b>		<b>ESC+X23</b>	
Hexadecimal code	ESC <1B> <sub>16</sub>	X23 <58> <sub>16</sub> <32> <sub>16</sub> <33> <sub>16</sub>	Parameter ,an - n
Initial setting	None		
Persistence of the command	When printer is powered off	Set parameter will not be retained	
	Validity in a job	Becomes invalid after execution	
	Validity after a job	Becomes invalid after the job	

[Function]

Font with the basic size of: width 48 dots, height 48 dots is specified.

[Format]

<X23>,an~n

• Parameter

a [Smoothing] = 0 : Smoothing OFF  
 1 : Smoothing ON  
 (Only available if expansion factor is between 3 and 12)

n [Print data] = Data

[Coding example]

<A>  
 <V>100<H>200<P>2<L>0304<X23>,0ABCDE  
 <Q>2  
 <Z>

[Notes]

1. The X23 font allows the setting of a fixed pitch or the setting of a proportional pitch.
2. If setting the smoothing option, and the expansion ratio <L> is 1 or 2, the smoothing function will be ignored.

[Valid commands]

Print position	<V>	<H>								
Modification	<P>	<L>	<%>	<PS>	<PR>	<F>	<&>	</>	<O>	<WD>
Barcode	<D><d>									

## X23 font character set

Basic size is 48 x 48 dots (width x height)

	0	1	2	3	4	5	6	7	8	9	A	B	C	D	E	F
0			0	@	P	'	p					一	夕	ミ		
1		!	1	A	Q	a	q			。	ア	チ	ム			
2		"	2	B	R	b	r				「	イ	ツ	メ		
3		#	3	C	S	c	s				」	ウ	テ	モ		
4		\$	4	D	T	d	t				、	エ	ト	ヤ		
5		%	5	E	U	e	u				・	オ	ナ	ユ		
6		&	6	F	V	f	v				ヲ	カ	ニ	ヨ		
7		'	7	G	W	g	w				ア	キ	ヌ	ラ		
8		(	8	H	X	h	x				イ	ク	ネ	リ		
9		)	9	I	Y	i	y				ウ	ケ	ノ	ル		
A		*	:	J	Z	j	z				エ	コ	ハ	レ		
B		+	;	K	[	k	{				オ	サ	ヒ	ロ		
C		,	<	L	¥	l	;				ヤ	シ	フ	ワ		
D		-	=	M	]	m	}				ユ	ス	ヘ	ン		
E		.	>	N	^	n	~				ヨ	セ	ホ	°		
F		/	?	O	_	o					ツ	ソ	マ	°		

The print sample shown above is issued with a head density of 8 dots/mm and a expansion factor of 1 (vertical/horizontal).

8.5 Font				
Available for	CT400/410/420	CT400-2/410-2/420-2	CT408i/412i/424i	
<b>X24 font (Basic size 48x48 dots)</b>			<b>ESC+X24</b>	
Hexadecimal code	ESC <1B> <sub>16</sub>	X24 <58> <sub>16</sub> <32> <sub>16</sub> <34> <sub>16</sub>	Parameter ,an~n	
Initial setting	None			
Persistence of the command	When printer is powered off	Set parameter will not be retained		
	Validity in a job	Becomes invalid after execution		
	Validity after a job	Becomes invalid after the job		

[Function]

Font with the basic size of: width 48 dots, height 48 dots is specified.

[Format]

<X24>,an~n

• Parameter

a [Smoothing] = 0 : Smoothing OFF  
 1 : Smoothing ON  
 (Only available if expansion factor is between 3 and 12)

n [Print data] = Data

[Coding example]

<A>  
 <V>100<H>200<P>2<L>0304<X24>.0ABCDE  
 <Q>2  
 <Z>

[Notes]

1. The X24 font allows the setting of a fixed pitch or the setting of a proportional pitch.
2. If setting the smoothing option, and the expansion <L> command is set to 1 or 2, the smoothing function will be ignored.

[Valid commands]

Print position	<V>	<H>								
Modification	<P>	<L>	<%>	<PS>	<PR>	<F>	<&>	</>	<O>	<WD>
Barcode	<D><d>									

## X24 font character set

Basic size is 48 x 48 dots (width x height)

	0	1	2	3	4	5	6	7	8	9	A	B	C	D	E	F
0			0	@	P	'	p					一	夕	ミ		
1		!	1	A	Q	a	q			。	ア	チ	ム			
2		"	2	B	R	b	r				「	イ	ツ	メ		
3		#	3	C	S	c	s				」	ウ	テ	モ		
4		\$	4	D	T	d	t				、	エ	ト	ヤ		
5		%	5	E	U	e	u				・	オ	ナ	ユ		
6		&	6	F	V	f	v				ヲ	カ	ニ	ヨ		
7		'	7	G	W	g	w				ア	キ	ヌ	ラ		
8		(	8	H	X	h	x				イ	ク	ネ	リ		
9		)	9	I	Y	i	y				ウ	ケ	ノ	ル		
A		*	:	J	Z	j	z				エ	コ	ハ	レ		
B		+	;	K	[	k	{				オ	サ	ヒ	ロ		
C		,	<	L	¥	l	;				ヤ	シ	フ	フ		
D		-	=	M	]	m	}				ユ	ス	ヘ	ン		
E		.	>	N	^	n	~				ヨ	セ	ホ	°		
F		/	?	O	_	o					ツ	ソ	マ			

The print sample shown above is issued with a head density of 8 dots/mm and an expansion factor of 1 (vertical/horizontal).

8.6 Font				
Available for	CT400/410/420	CT400-2/410-2/420-2	CT408i/412i/424i	
<b>XU font (Basic size 5x9 dots)</b>			<b>ESC+XU</b>	
Hexadecimal code	ESC <1B> <sub>16</sub>	XU <58> <sub>16</sub> <55> <sub>16</sub>	Parameter n - n	
Initial setting	None			
Persistence of the command	When printer is powered off	Set parameter will not be retained		
	Validity in a job	Becomes invalid after execution		
	Validity after a job	Becomes invalid after the job		

[Function]

Font with the basic size of: width 5 dots, height 9 dots is specified.

[Format]

<XU> n~n

- Parameter  
n [Print data] = Data

[Coding example]

```
<A>
<V>100<H>200<P>2<L>0304<XU>ABCDE
<Q>2
<Z>
```

[Notes]

1. The XU font allows the setting of a fixed pitch or the setting of a proportional pitch.
2. The setting of the fixed / proportional pitch is done in the command settings.

[Valid commands]

Print position	<V>	<H>								
Modification	<P>	<L>	<%>	<PS>	<PR>	<F>	<&>	</>	<0>	<WD>
Barcode	<D><d>									



# XU font character set

Basic size is 5 x 9 dots (width x height)

	2	3	4	5	6	7	8	9	A	B	C	D	E	F
0	ø	ø	P	`	p	ç	é	á			ø	ó	-	
1	!	1	A	Q	a	q	ü	æ	í			ð	þ	±
2	"	2	B	R	b	r	é	æ	ó			é	ó	=
3	#	3	C	S	c	s	á	ó	ú			é	ó	æ
4	\$	4	D	T	d	t	ä	ö	ñ			é	ó	
5	%	5	E	U	e	u	ä	ö	ñ	á		€	ø	£
6	&	6	F	V	f	v	ä	ú	æ	á	ä	í	µ	+
7	'	7	G	W	g	w	ç	ú	é	á	æ	í		
8	<	8	H	X	h	x	é	ý	ó	ø		í		°
9	>	9	I	Y	i	y	é	ö					ú	¨
A	*	:	J	Z	j	z	é	ü	™				ó	*
B	+	;	K	I	k	{	í	ø	æ				ú	l
C	,	<	L	\	l		í	£	æ				ý	æ
D	-	=	M	I	m	}	í	ø	í	ø			ý	æ
E	.	>	N	^	n	-	æ	x	«	¥			í	-
F	/	?	O	_	o		á	f	»				'	

The print sample shown above is issued with a head density of 12 dots/mm and a expansion factor of 3 (vertical/horizontal).

8.7 Font			
Available for	CT400/410/420	CT400-2/410-2/420-2	CT408i/412i/424i
<b>XS font (Basic size 17x17 dots)</b>		<b>ESC+XS</b>	
Hexadecimal code	ESC <1B> <sub>16</sub>	XS <58> <sub>16</sub> <53> <sub>16</sub>	Parameter n~n
Initial setting	None		
Persistence of the command	When printer is powered off	Set parameter will not be retained	
	Validity in a job	Becomes invalid after execution	
	Validity after a job	Becomes invalid after the job	

[Function]

Font with the basic size of: width 17 dots, height 17 dots is specified.

[Format]

<XS>n~n

- Parameter  
n [Print data] = Data

[Coding example]

```
<A>
<V>100<H>200<P>2<L>0304<XS>ABCDE
<Q>2
<Z>
```

[Notes]

1. The XS font allows the setting of a fixed pitch or the setting of a proportional pitch.
2. The setting of the fixed / proportional pitch is done in the command settings.

[Valid commands]

Print position	<V>	<H>								
Modification	<P>	<L>	<%>	<PS>	<PR>	<F>	<&>	</>	<0>	<WD>
Barcode	<D><d>									

# XS font character set

Basic size is 17 x 17 dots (width x height)

	2	3	4	5	6	7	8	9	A	B	C	D	E	F
0	ø	@	P	'	p	ç	É	á	ø		ð	ó	-	
1	!	1	A	Q	a	q	ü	æ	í		ø	β	±	
2	"	2	B	R	b	r	é	Æ	ó		É	ó	=	
3	#	3	C	S	c	s	â	ô	ú		É	ó	%	
4	\$	4	D	T	d	t	ä	ö	ñ		É	ó	¶	
5	%	5	E	U	e	u	à	ò	Ñ	Á	€	ö	§	
6	&	6	F	V	f	v	â	û	ä	ã	í	µ	÷	
7	'	7	G	W	g	w	ç	ù	ó	À	Ã	ı	~	
8	(	8	H	X	h	x	ê	ÿ	ı	©	ÿ	ı	°	
9	)	9	I	Y	i	y	ë	ü	®			ü	..	
A	*	:	J	Z	j	z	è	ü	¬			ü	.	
B	+	;	K	[	k	{	ı	ø	½			ü	¹	
C	,	<	L	\	l	!	ı	£	¼			ý	ª	
D	-	=	M	]	m	}	ı	ø	ı	ø	ı	ı	²	
E	.	>	N	^	n	~	Ä	x	«	¥	ı	ı		
F	/	?	O	_	o		Å	f	»			ı		

The print sample shown above is issued with a head density of 12 dots/mm and a expansion factor of 2 (vertical/horizontal).

8.8 Font				
Available for	CT400/410/420	CT400-2/410-2/420-2	CT408i/412i/424i	
<b>XM font (Basic size 24x24 dots)</b>			<b>ESC+XM</b>	
Hexadecimal code	ESC <1B> <sub>16</sub>	XM <58> <sub>16</sub> <4D> <sub>16</sub>	Parameter n~n	
Initial setting	None			
Persistence of the command	When printer is powered off	Set parameter will not be retained		
	Validity in a job	Becomes invalid after execution		
	Validity after a job	Becomes invalid after the job		

[Function]

Font with the basic size of: width 24 dots, height 24 dots is specified.

[Format]

<XM>n~n

- Parameter  
n [Print data] = Data

[Coding example]

```
<A>
<V>100<H>200<P>2<L>0304<XM>ABCDE
<Q>2
<Z>
```

[Notes]

1. The XM font allows the setting of a fixed pitch or the setting of a proportional pitch.
2. The setting of the fixed / proportional pitch is done in the command settings.

[Valid commands]

Print position	<V>	<H>								
Modification	<P>	<L>	<%>	<PS>	<PR>	<F>	<&>	</>	<0>	<WD>
Barcode	<D><d>									

## XM font character set

Basic size is 24 x 24 dots (width x height)

	2	3	4	5	6	7	8	9	A	B	C	D	E	F
0	0	@	P	`	p	Ç	É	á	ø		ð	Ó	-	
1	!	1	A	Q	a	q	ü	æ	í		Ð	β	±	
2	"	2	B	R	b	r	é	Æ	ó		É	Ö	=	
3	#	3	C	S	c	s	â	ô	ú		È	Ò	¾	
4	\$	4	D	T	d	t	ä	ö	ñ		Ê	õ	¶	
5	%	5	E	U	e	u	à	ò	Ñ	À	€	Ö	§	
6	&	6	F	V	f	v	ã	û	ä	Â	ã	í	μ	÷
7	'	7	G	W	g	w	ç	ù	º	Á	Ã	î	þ	-
8	(	8	H	X	h	x	ê	ÿ	ÿ	©		ï	þ	o
9	)	9	I	Y	i	y	ë	Ö	®			ú	--	
A	*	:	J	Z	j	z	è	Ü	¬			ü	-	
B	+	;	K	[	k	{	ï	ø	½		■	ü	¹	
C	,	<	L	\	l		î	£	¼			ý	³	
D	-	=	M	]	m	}	ï	ø	ï	¢		ÿ	²	
E	.	>	N	^	n	~	Ä	x	<<	¥		ÿ	-	
F	/	?	O	_	o		Å	f	>>				'	

The print sample shown above is issued with a head density of 12 dots/mm and a expansion factor of 2 (vertical/horizontal).

8.9 Font				
Available for	CT400/410/420	CT400-2/410-2/420-2	CT408i/412i/424i	
<b>XB font (Basic size 48x48 size)</b>			<b>ESC+XB</b>	
Hexadecimal code	ESC <1B> <sub>16</sub>	XB <58> <sub>16</sub> <42> <sub>16</sub>	Parameter an~n	
Initial setting	a=0			

Persistence of the command	When printer is powered off	Set parameter will not be retained
	Validity in a job	Becomes invalid after execution
	Validity after a job	Becomes invalid after the job

[Function]

Font with the basic size of: width 48 dots, height 48 dots is specified.

[Format]

<XB>an - n

• Parameter

a	[Smoothing]	=	0: Smoothing OFF 1: Smoothing ON (Valid for expansion factors <L> between 3 and 12)
n	[Print data]	=	Data

[Coding example]

```
<A>
<V>100<H>200<P>2<L>0304<XB>0ABCDE
<Q>2
<Z>
```

[Notes]

1. The XB font allows the setting of a fixed pitch or the setting of a proportional pitch.
2. The setting of the fixed / proportional pitch is done in the command settings.
3. If setting the smoothing option, and the expansion <L> command is set to 1 or 2, the smoothing function will be ignored.

[Valid commands]

Print position	<V>	<H>								
Modification	<P>	<L>	<%>	<PS>	<PR>	<F>	<&>	</>	<0>	<WD>
Barcode	<D><d>									

## XB font character set

Basic size is 48 x 48 dots (width x height)

	2	3	4	5	6	7	8	9	A	B	C	D	E	F
0	ø	@	P	`	p	Ç	É	á	ø		ø	ó	-	
1	!	1	A	Q	a	q	ü	æ	í			Ð	β	±
2	"	2	B	R	b	r	é	Æ	ó			È	ó	=
3	#	3	C	S	c	s	â	ô	ú			È	ó	¼
4	\$	4	D	T	d	t	ä	ö	ñ			È	ó	¶
5	%	5	E	U	e	u	à	ò	Ñ	Á		€	ó	§
6	&	6	F	V	f	v	á	û	ä	ã	í	μ	÷	
7	'	7	G	W	g	w	ç	ù	ø	À	Ã	í	þ	·
8	(	8	H	X	h	x	ê	ÿ	¿	©		ÿ	þ	°
9	)	9	I	Y	i	y	ë	ö	®			ü	·	
A	*	:	J	Z	j	z	è	Ü	¬			ü	·	
B	+	;	K	[	k	{	ï	ø	½			ü	¹	
C	,	<	L	\	l	!	î	£	¼			ý	³	
D	-	=	M	]	m	}	ï	ø	í	ø		!	Ý	²
E	.	>	N	^	n	~	Ä	×	«	¥		í	-	
F	/	?	O	_	o		Å	f	»				´	

The print sample shown above is issued with a head density of 12 dots/mm and a expansion factor of 1 (vertical/horizontal).

8.10 Font				
Available for	CT400/410/420	CT400-2/410-2/420-2	CT408i/412i/424i	
<b>XL font (Basic size 48x48 dots)</b>			<b>ESC+XL</b>	
Hexadecimal code	ESC <1B> <sub>16</sub>	XL <58> <sub>16</sub> <4C> <sub>16</sub>	Parameter an~n	
Initial setting	None			
Persistence of the command	When printer is powered off	Set parameter will not be retained		
	Validity in a job	Becomes invalid after execution		
	Validity after a job	Becomes invalid after the job		

[Function]

Font with the basic size of: width 48 dots, height 48 dots is specified.

[Format]

<XL>an~n

• Parameter

a	[Smoothing]	=	0: Smoothing OFF 1: Smoothing ON (Valid for expansion factors <L> between 3 and 12)
n	[Print data]	=	Data

[Coding example]

```
<A>
<V>100<H>200<P>2<L>0304<XL>0ABCDE
<Q>2
<Z>
```

[Notes]

1. The XL font allows the setting of a fixed pitch or the setting of a proportional pitch.
2. The setting of the fixed / proportional pitch is done in the command settings.
3. If setting the smoothing option, and the expansion <L> command is set to 1 or 2, the smoothing function will be ignored.

[Valid commands]

Print position	<V>	<H>								
Modification	<P>	<L>	<%>	<PS>	<PR>	<F>	<&>	</>	<0>	<WD>
Barcode	<D><d>									



# XL font character set

Basic size is 48 x 48 dots (width x height)

	2	3	4	5	6	7	8	9	A	B	C	D	E	F
0		0	@	P	'	p	Ç	É	á	Ø		ð	Ó	-
1	!	1	A	Q	a	q	ü	æ	í			Ð	β	±
2	"	2	B	R	b	r	é	Æ	ó			Ê	Ô	=
3	#	3	C	S	c	s	â	ô	ú			Ë	Ò	¾
4	\$	4	D	T	d	t	ä	ö	ñ			È	õ	¶
5	%	5	E	U	e	u	à	ò	Ñ	Á		€	Õ	§
6	&	6	F	V	f	v	â	û	ª	Â	ã	í	μ	÷
7	'	7	G	W	g	w	ç	ù	º	À	Ã	î	þ	·
8	(	8	H	X	h	x	ê	ÿ	¿	©		Ï	þ	°
9	)	9	I	Y	i	y	ë	ÿ	®			Û	ü	•
A	*	:	J	Z	j	z	è	Ü	¬			Ü	ü	•
B	+	;	K	[	k	{	ï	ø	½			Ü	ü	•
C	,	<	L	\	l		î	£	¼			ÿ	ÿ	³
D	-	=	M	]	m	}	ï	ø	ï	ø		ÿ	ÿ	²
E	.	>	N	^	n	~	Ä	x	«	¥		ÿ	ÿ	
F	/	?	O	_	o		Å	f	»			ÿ	ÿ	

The print sample shown above is issued with a head density of 12 dots/mm and a expansion factor of 1 (vertical/horizontal).

8.11 Font				
Available for	CT400/410/420		CT400-2/410-2/420-2	
	CT408i/412i/424i			
<b>OCR-A font</b>			<b>ESC+OA</b>	
Hexadecimal code	ESC	OA	Parameter	
	<1B> <sub>16</sub>	<4F> <sub>16</sub> <41> <sub>16</sub>	n~n	
Initial setting	None			

Persistence of the command	When printer is powered off	Set parameter will not be retained
	Validity in a job	Becomes invalid after execution
	Validity after a job	Becomes invalid after the job

[Function]  
Specifies OCR-A font.

[Format]  
<OA>n~n  
 • Parameter  
 n [Print data] = Data

[Coding example]  
 <A>  
 <V>100<H>100<P>2<L>0202<OA>ABC  
 <Q>2  
 <Z>

[Font size table]

Printer	Font size (dots)
CT400DT/TT, CT400-2DT/TT, CT408iDT/TT	W15 x H22
CT410DT/TT, CT410-2DT/TT, CT412iDT/TT, CT420DT/TT, CT420-2DT/TT, CT424iDT/TT	W22 x H33

[Valid commands]

Print position	<V>	<H>							
Modification	<P>	<L>	<%>	<F>	<&>	</>	<0>	<WD>	
Barcode	<D><d>								

## OCR-A font character set

OCR-A font settings.

	2	3	4	5	6	7	8	9	A	B	C	D	E	F
0		0		P										
1		1	A	Q										
2		2	B	R										
3		3	C	S										
4	4	4	D	T										
5		5	E	U										
6		6	F	V										
7		7	G	W										
8		8	H	X										
9		9	I	Y										
A			J	Z										
B			K											
C			L											
D			M											
E	.	>	N											
F	/		o											

The print sample shown above is issued with a head density of 12 dots/mm, a font size of 22x33, and a expansion factor of 1 (vertical/horizontal).

8.12 Font				
Available for				
	CT400/410/420	CT400-2/410-2/420-2	CT408i/412i/424i	
OCR-B font			ESC+OB	
Hexadecimal code	ESC	OB	Parameter	
	<1B> <sub>16</sub>	<4F> <sub>16</sub> <42> <sub>16</sub>	n~n	
Initial setting	None			

Persistence of the command	When printer is powered off	Set parameter will not be retained
	Validity in a job	Becomes invalid after execution
	Validity after a job	Becomes invalid after the job

[Function]  
Specifies OCR-B font.

[Format]  
<OB>n~n  
 • Parameter  
 n [Print data] = Data

[Coding example]  
 <A>  
 <V>100<H>100<P>2<L>0202<OB>ABC  
 <Q>2  
 <Z>

[Font size table]

Printer	Font size (dots)
CT400DT/TT, CT400-2DT/TT, CT408iDT/TT	W20 x H24
CT410DT/TT, CT410-2DT/TT, CT412iDT/TT, CT420DT/TT, CT420-2DT/TT, CT424iDT/TT	W30 x H36

[Valid commands]

Print position	<V>	<H>								
Modification	<P>	<L>	<%>	<F>	<&>	</>	<0>	<WD>		
Barcode	<D><d>									

## OCR-B font character set

OCR-B font settings.

	2	3	4	5	6	7	8	9	A	B	C	D	E	F
0		0	@	P										
1	!	1	A	Q										
2	"	2	B	R										
3	#	3	C	S										
4	\$	4	D	T										
5	%	5	E	U										
6	&	6	F	V										
7	'	7	G	W										
8	(	8	H	X										
9	)	9	I	Y										
A	*	:	J	Z										
B	+	;	K	¥										
C	,	<	L	¥										
D	-	=	M											
E	.	>	N											
F	/	?	O											

The print sample shown above is issued with a head density of 12 dots/mm, a font size of 30x36, and a expansion factor of 1 (vertical/horizontal).

8.13 Font			
Available for	CT400/410/420	CT400-2/410-2/420-2	CT408i/412i/424i
Outline font design		ESC+\$	
Hexadecimal code	ESC <1B> <sub>16</sub>	\$ <24> <sub>16</sub>	Parameter a,bbb,ccc,d
Initial setting	None		

Persistence of the command	When printer is powered off	Set parameter will not be retained.
	Validity in a job	Set parameter will be retained until next valid setting.
	Validity after a job	Set parameter will be the initial value for the next job <A>.

[Function]

Specifies type, design, size of outline font

[Format]

<\$>a,bbb,ccc,d

• Parameter

a	[Font type selection]	=	A	:	Helvetica Bold (Proportional)
			B	:	Helvetica Bold (Inter-character pitch fixed)
b	[Font width]	=	Valid range	:	24 to 999 dots
c	[Font height]	=	Valid range	:	24 to 999 dots
d	[Font design]	=	0	:	Normal font (Black)
			1	:	White characters on black background
			2	:	Grey font (Pattern 1)
			3	:	Grey font (Pattern 2)
			4	:	Grey font (Pattern 3)
			5	:	Font with shadow
			6	:	White characters with shadow on black background
			7	:	Mirrored font
			8	:	Normal italic font
			9	:	White italic characters with shadow on black background

[Coding example] Font type: A, font width: 100 dots, font height: 100 dots, font design: 1

```
<A>
<V>>100<H>100<P>2
<$>A,100,100,1<=$>SATO
<Q>2
<Z>
```

[Notes]

1. The outline font printing command <\$=> shall be executed after the outline font design selection <\$>.
2. Font height includes both ascender and descender area. For proportional pitch, the character width of outline font differs depending on the font to be used.
3. Use character pitch command <P> to specify font pitch.
4. Italic characters are tilt in an angle of 15-degree, within their specified width. As for the height specification, both ascender and descender area are included.
5. For the font design 1 thru 9, if the specified dot setting is irregularly small, the font can not be identified.
6. If the font width / height are very small, there can be cases that the font is squeezed.

[Valid commands]

Modification	<\$=>								
--------------	-------	--	--	--	--	--	--	--	--

8.14 Font			
Available for	CT400/410/420	CT400-2/410-2/420-2	CT408i/412i/424i
<b>Outline font printing</b>		<b>ESC+\$=</b>	
Hexadecimal code	ESC <1B> <sub>16</sub>	\$= <24> <sub>16</sub> <3D> <sub>16</sub>	Parameter n~n
Initial setting	None		
Persistence of the command	When printer is powered off	Set parameter will not be retained	
	Validity in a job	Becomes invalid after execution	
	Validity after a job	Becomes invalid after the job	

[Function]

Specifies printing command of outline font

[Format]

<\$=>n~n

•Parameter

n [Print data] = Data

[Coding example] Print data: SATO

<A>

<V>100<H>100<P>2

<\$>A,100,100,1<\$=>**SATO**

<Q>2

<Z>

[Notes]

- The outline font printing command <\$=> shall be executed after the outline font design selection <\$>.

[Valid commands]

Print position	<V>	<H>								
Modification	<P>	<%>	<\$>	<F>						

## Outline font character set

Outline font settings

	2	3	4	5	6	7	8	9	A	B	C	D	E	F
0	ø	@	P	'	p	Ç	É	á			ø	Ó	-	
1	!	1	A	Q	a	q	ü	æ	í			Ð	β	±
2	"	2	B	R	b	r	é	Æ	ó			Ê	Ô	=
3	#	3	C	S	c	s	â	ô	ú			Ë	Ò	‰
4	\$	4	D	T	d	t	ä	ö	ñ			È	õ	
5	%	5	E	U	e	u	à	ò	Ñ	Á		€	Ö	
6	&	6	F	V	f	v	á	ú	a	À	á	Í	μ	÷
7	'	7	G	W	g	w	ç	ù	ø	Â	Ã	Î	þ	.
8	(	8	H	X	h	x	é	ý	¿	ø		Ï	þ	°
9	)	9	I	Y	i	y	ë	Ö	®			Ú	"	
A	*	:	J	Z	j	z	è	Ü	¬			Û	.	
B	+	;	K	[	k	{	ı	ø	½			Ü	'	
C	,	<	L	\	l		ı	£	¼			ý	*	
D	-	=	M	]	m	}	ı	ø	ı	¢		Ý	*	
E	.	>	N	^	n	~	À	x	«	¥		İ	-	
F	/	?	O	_	o		Á	f	»					

The print sample shown above is issued with a head density of 12 dots/mm, normal font, and a font size of 50x50 (vertical/horizontal).



8.15 Font				
Available for				
	CT400/410/420	CT400-2/410-2/420-2	CT408i/412i/424i	
<b>CG font</b>			<b>ESC+RD</b>	
Hexadecimal code	ESC	RD	Parameter	
	<1B> <sub>16</sub>	<52> <sub>16</sub> <44> <sub>16</sub>	abb,ccc,ddd,n~n	
Initial setting	None			

Persistence of the command	When printer is powered off	Set parameter will not be retained
	Validity in a job	Becomes invalid after execution
	Validity after a job	Becomes invalid after the job

[Function]

Specifies CG font type, font style, font size and print data

[Format]

<RD>abb,ccc,ddd,n~n

• Parameter

a	[Font type]	=	A [CG Times] B [CG Triumvirate]
b	[Font style]	=	00 Fixed
c	[Horizontal size (width)]	=	Valid range: 004 and 999 dots. Refer to the table below Valid range: P02 and P99 points
d	[Vertical size (height)]	=	Valid range: 004 and 999 dots. Refer to the table below Valid range: P02 and P99 points
n	[Print data]	=	Data

[Coding example]

<A>  
<V>100<H>100<P>2  
**<RD>A00.P10.P10.SATO**  
<Q>2  
<Z>

[Notes]

1. The font size is set by [dot number] or [point number].
2. The dot size does vary with printer type. (Refer top table below)
3. 1 point is 0.35mm.

[Dot size]

Printer	Size of 1 dot (mm)
CT400DT/TT, CT400-2DT/TT, CT408iDT/TT	0.125
CT410DT/TT, CT410-2DT/TT, CT412iDT/TT	0.083
CT420DT/TT, CT420-2DT/TT, CT424iDT/TT	0.042

[Range of font size]

Printer	Valid range: Horizontal (dots)	Valid range: Vertical (dots)
CT400DT/TT, CT400-2DT/TT, CT408iDT/TT	4 and 832	4 and 999
CT410DT/TT, CT410-2DT/TT, CT412iDT/TT CT420DT/TT, CT420-2DT/TT, CT424iDT/TT	4 and 999	4 and 999

[Valid commands]

Print position	<V>	<H>								
Modification	<P>	<%>	<PS>	<PR>	<F>					

# CG Times font character set

CG Times font settings

	2	3	4	5	6	7	8	9	A	B	C	D	E	F
0	0	@	P	`	p	Ç	É	á	0		ø	Ó	-	
1	!	1	A	Q	a	q	ü	æ	í			Ð	ß	±
2	"	2	B	R	b	r	é	Æ	ó			Ê	Ô	_
3	#	3	C	S	c	s	â	ô	ú			Ë	Ò	<sup>3</sup> / <sub>4</sub>
4	\$	4	D	T	d	t	ä	ö	ñ			È	õ	¶
5	%	5	E	U	e	u	à	ò	Ñ	Á			Õ	§
6	&	6	F	V	f	v	á	û	<sup>a</sup>	Â	ã	Í	μ	÷
7	'	7	G	W	g	w	ç	ù	°	À	Ã	Î	þ	,
8	(	8	H	X	h	x	ê	ÿ	ı	©		İ	Ɔ	°
9	)	9	I	Y	i	y	ë	Ö	®				Ú	ˆ
A	*	:	J	Z	j	z	è	Ü	¬				Û	·
B	+	;	K	[	k	{	ï	ø	<sup>1</sup> / <sub>2</sub>				Ü	<sup>1</sup>
C	,	<	L	\	l		î	£	<sup>1</sup> / <sub>4</sub>				Ý	<sup>3</sup>
D	-	=	M	]	m	}	ì	Ø	ı	ç			Ÿ	<sup>2</sup>
E	.	>	N		n		Ä	×	«	¥			ı	-
F	/	?	O	_	o		Å	f	»					'

The print sample shown above is issued with a head density of 12 dots/mm, and a font size of 48x48 (vertical/horizontal).

# CG Triumvirate font character set

CG Triumvirate font settings

	2	3	4	5	6	7	8	9	A	B	C	D	E	F
<b>0</b>	0	@	P	`	p	Ç	É	á	0		ö	Ó	-	
<b>1</b>	!	1	A	Q	a	q	ü	æ	í		Đ	ß	±	
<b>2</b>	"	2	B	R	b	r	é	Æ	ó		Ê	Ô		
<b>3</b>	#	3	C	S	c	s	â	ô	ú		Ë	Ò	¾	
<b>4</b>	\$	4	D	T	d	t	ä	ö	ñ		È	õ	¶	
<b>5</b>	%	5	E	U	e	u	à	ò	Ñ	Á		Õ	§	
<b>6</b>	&	6	F	V	f	v	å	û	ª	Â	ã	í	µ	÷
<b>7</b>	'	7	G	W	g	w	ç	ù	º	À	Ã	î	þ	.
<b>8</b>	(	8	H	X	h	x	ê	ÿ	¿	©		ï	ƒ	°
<b>9</b>	)	9	I	Y	i	y	ë	Ö	®			Ú	¨	
<b>A</b>	*	:	J	Z	j	z	è	Ü	¬			Û	·	
<b>B</b>	+	;	K	[	k	{	ï	ø	½			Ù	¹	
<b>C</b>	,	<	L	\	l		î	£	¼			Ý	³	
<b>D</b>	-	=	M	]	m	}	ì	Ø	ì	¢			Ý	²
<b>E</b>	.	>	N	^	n	~	Ä	×	«	¥		ì		
<b>F</b>	/	?	O	_	o		Å	f	»				'	

The print sample shown above is issued with a head density of 12 dots/mm, and a font size of 48x48 (vertical/horizontal).

## 8.16 Font

Available for	CT400/410/420	CT400-2/410-2/420-2	CT408i/412i/424i
<b>16x16 dots horizontally oriented Kanji (JIS or Shift JIS)</b>			<b>ESC+K1</b>
Hexadecimal code	ESC <1B> <sub>16</sub>	K1 <4B> <sub>16</sub> <31> <sub>16</sub>	Parameter an~n
Initial setting	None		

Persistence of the command	When printer is powered off	Set parameter will not be retained
	Validity in a job	Becomes invalid after execution
	Validity after a job	Becomes invalid after the job

### [Function]

Specifies 16x16 (width x height) dot horizontal written Kanji character print

### [Format]

<K1>an~n

#### • Parameter

a [Kanji selection mode] = H : HEX character letters  
 B : Binary code  
 I : HEX character letters, smoothed  
 C : Binary code, smoothed  
 J : HEX character letters, focused  
 D : Binary code, focused  
 K : HEX character letters, smoothed and focused  
 E : Binary character letters, smoothed and focused

n [Data] = Refer to JIS / Shift JIS Kanji code table

[Coding example 1] HEX characters of Shift JIS, horizontal expansion factor: 3, vertical expansion factor: 5

```
<A>
<V>100<H>200<P>2<L>0305
<K1>H81698A94816A83548367815B
<Q>2
<Z>
```

[Coding example 2] Binary code of JIS, horizontal expansion factor: 2, vertical expansion factor: 3

```
<A>
<V>100<H>200<P>2<L>0203
<K1>B!J3t!K%5%H!<
<Q>2
<Z>
```

### [Notes]

1. HEX characters = Kanji Code 4 bytes ASCII / 1 Kanji character
2. Binary code = Kanji Code 2 bytes / 1 Kanji character
3. Smoothing function validity range = Horizontal/vertical validity range : factor 3 and 12
4. Focusing function validity range = Horizontal/vertical validity range : factor 1 and 5

### [Tips]

1. With the highlighting function the character width enlarges proportional with the expansion factor.
2. Using the highlighting function, in some cases, depending on the type of font, characters become squeezed.
3. For CT Series printers, the optional Kanji ROM is needed for using this command.

### [Valid commands]

Print position	<V>	<H>							
Modification	<P>	<L>	<%>	<&>	</>	<0>	<WD>		

## 8.17 Font

Available for	CT400/410/420	CT400-2/410-2/420-2	CT408i/412i/424i
<b>24x24 dots horizontally oriented Kanji (JIS or Shift JIS)</b>			<b>ESC+K2</b>
Hexadecimal code	ESC <1B> <sub>16</sub>	K2 <4B> <sub>16</sub> <32> <sub>16</sub>	Parameter an~n
Initial setting	None		

Persistence of the command	When printer is powered off	Set parameter will not be retained
	Validity in a job	Becomes invalid after execution
	Validity after a job	Becomes invalid after the job

### [Function]

Specifies 24x24 (width x height) dot horizontal written Kanji character print

### [Format]

<K2>an~n

#### • Parameter

a [Kanji selection mode] = H : HEX characters  
 B : Binary code  
 I : HEX characters with smoothing function  
 C : Binary code with smoothing function  
 J : HEX characters with highlighting function  
 D : Binary code with highlighting function  
 K : HEX characters with smoothing and highlighting functions  
 E : Binary characters with smoothing and highlighting functions

n [Data] = Refer to JIS or Shift JIS Kanji code table

[Coding example 1] HEX character of Shift JIS, horizontal expansion factor: 3, vertical expansion factor: 5

```
<V>100<H>200<P>2<L>0305
<K2>H81698A94816A83548367815B
<Q>2
<Z>
```

[Coding example 2] Binary code of JIS, horizontal expansion factor: 2, vertical expansion factor: 3

```
<A>
<V>100<H>200<P>2<L>0203
<K2>B!J3t!K%5%H!<
<Q>2
<Z>
```

### [Notes]

1. HEX characters = Kanji Code 4 bytes ASCII / 1 Kanji character
2. Binary code = Kanji Code 2 bytes / 1 Kanji character
3. Smoothing function validity range = Horizontal/vertical validity range : factor 3 and 12
4. Highlighting function validity range = Horizontal/vertical validity range : factor 1 and 5

### [Tips]

1. With the highlighting function the character width enlarges proportional with the expansion factor.
2. Using the highlighting function, in some cases, depending on the type of font, characters become squeezed.
3. For CT Series printers, the optional Kanji ROM is needed for using this command.

### [Valid commands]

Print position	<V>	<H>	<P>	<L>	<WD>	<Q>	<Z>			
Modification	<P>	<L>	<%>	<&>	</>	<0>	<WD>			

8.18 Font				
Available for				
	CT400/410	CT400-2/410-2	CT408i/412i	CT420/CT420-2/CT424i
22x22 dots horizontally oriented Kanji (JIS or Shift JIS)			ESC+K3	
Hexadecimal code	ESC <1B> <sub>16</sub>	K3 <4B> <sub>16</sub> <33> <sub>16</sub>	Parameter an~n	
Initial setting	None			
Persistence of the command	When printer is powered off		Set parameter will not be retained	
	Validity in a job		Becomes invalid after execution	
	Validity after a job		Becomes invalid after the job	

[Function]

Specifies 22x22(width x height) dot horizontal written Kanji character print

[Format]

<K3>an~n

• Parameter

- |   |                        |   |                                                                                                                                                                                                                                                                                                                                                          |
|---|------------------------|---|----------------------------------------------------------------------------------------------------------------------------------------------------------------------------------------------------------------------------------------------------------------------------------------------------------------------------------------------------------|
| a | [Kanji selection mode] | = | H : HEX characters<br>B : Binary code<br>I : HEX characters with smoothing function<br>C : Binary code with smoothing function<br>J : HEX characters with lighting function<br>D : Binary code with lighting function<br>K : HEX characters with smoothing and highlighting functions<br>E : Binary characters with smoothing and highlighting functions |
| n | [Data]                 | = | Refer to JIS or Shift JIS Kanji code table                                                                                                                                                                                                                                                                                                               |

[Coding example 1] HEX characters of Shift JIS, horizontal expansion factor: 3, vertical expansion factor: 5

```
<A>
<V>100<H>200<P>2<L>0305
<K3>H81698A94816A83548367815B
<Q>2
<Z>
```

[Coding example 2] Binary code of JIS, horizontal expansion factor: 2, vertical expansion factor: 3

```
<A>
<V>100<H>200<P>2<L>0203
<K3>B!J3t!K%5%H!<
<Q>2
<Z>
```

[Notes]

- |                                         |   |                                                      |
|-----------------------------------------|---|------------------------------------------------------|
| 1. HEX characters                       | = | Kanji Code 4 bytes ASCII / 1 Kanji character         |
| 2. Binary code                          | = | Kanji Code 2 bytes / 1 Kanji character               |
| 3. Smoothing function validity range    | = | Horizontal/vertical validity range : factor 3 and 12 |
| 4. Highlighting function validity range | = | Horizontal/vertical validity range : factor 1 and 5  |

[Tips]

1. With the highlighting function, the character width enlarges proportional with the expansion factor.
2. Using the highlighting function, in some cases, depending on the type of font, characters become squeezed.
3. For CT Series printers, the optional Kanji ROM is needed for using this command.
4. This command is not available for CT420/420-2/424i printers.

[Valid commands]

Print position	<V>	<H>								
Modification	<P>	<L>	<%>	<&>	</>	<0>	<WD>			

## 8.19 Font

Available for	CT400/410/420	CT400-2/410-2/420-2	CT408i/412i/424i
<b>16×16 dots horizontally oriented Kanji with 1-byte character (Shift JIS only)</b>			<b>ESC+K8</b>
Hexadecimal code	ESC <1B> <sub>16</sub>	K8 <4B> <sub>16</sub> <38> <sub>16</sub>	Parameter an~n
Initial setting	None		

Persistence of the command	When printer is powered off	Set parameter will not be retained
	Validity in a job	Becomes invalid after execution
	Validity after a job	Becomes invalid after the job

### [Function]

Prints W16 x H16 dot horizontal written Kanji characters and W8 x H16 dot, 1 byte horizontal written characters

### [Format]

<K8>an~n

#### • Parameter

a [Kanji selection mode] = H : HEX characters  
 B : Binary code  
 I : HEX character letters with smoothing function  
 C : Binary code with smoothing function  
 J : HEX characters with highlighting function  
 D : Binary code with highlighting function  
 K : HEX characters with smoothing and highlighting functions  
 E : Binary characters with smoothing and highlighting functions

n [Data] = Refer to JIS or Shift JIS Kanji code table

[Coding example] HEX characters of Shift JIS, horizontal expansion factor: 3, vertical expansion factor: 5

```
<A>
<V>100<H>200<P>2<L>0305
<K8>H8A948EAE89EF8ED0BBC42D
<Q>2
<Z>
```

### [Notes]

1. HEX characters = Kanji Code 4 bytes ASCII / 1 Kanji character
2. Binary code = Kanji Code 2 bytes / 1 Kanji character
3. Smoothing function validity range = Horizontal/vertical validity range : factor 3 and 12
4. Highlighting function validity range = Horizontal/vertical validity range : factor 1 and 5

### [Tips]

1. With the highlighting function, the character width enlarges proportional with the expansion factor.
2. Using the highlighting function, in some cases, depending on the type of font, characters become squeezed.
3. This command can only be used with Shift JIS Kanji character code.
4. For 1 byte character, the print is executed in 8×16 dot size.
5. For 2 bytes character, the print is executed in 16×16 dot size.
6. For half size character, the print is done, regardless of gothic Kanji settings <KG>, in Roman font.
7. For CT Series printers, the optional Kanji ROM is needed for using this command.

### [Valid commands]

Print position	<V>	<H>							
Modification	<P>	<L>	<%>	<&>	</>	<0>	<WD>		

8.20 Font			
Available for	CT400/410/420	CT400-2/410-2/420-2	CT408i/412i/424i
24×24 dots horizontally oriented Kanji with 1-byte character (Shift JIS only)		ESC+K9	
Hexadecimal code	ESC <1B> <sub>16</sub>	K9 <4B> <sub>16</sub> <39> <sub>16</sub>	Parameter an~n
Initial setting	None		

Persistence of the command	When printer is powered off	Set parameter will not be retained
	Validity in a job	Becomes invalid after execution
	Validity after a job	Becomes invalid after the job

[Function]

Prints W24 x H24 dot horizontal written Kanji characters and W12 x H24 dot, 1 byte horizontal written characters

[Function]

<K9>an~n

• Parameter

- |   |                        |   |                                                                                                                                                                                                                                                                                                                                                                   |
|---|------------------------|---|-------------------------------------------------------------------------------------------------------------------------------------------------------------------------------------------------------------------------------------------------------------------------------------------------------------------------------------------------------------------|
| a | [Kanji selection mode] | = | H : HEX characters<br>B : Binary code<br>I : HEX characters with smoothing function<br>C : Binary code with smoothing function<br>J : HEX characters with highlighting function<br>D : Binary code with highlighting functions<br>K : HEX characters with smoothing and highlighting functions<br>E : Binary characters with smoothing and highlighting functions |
| n | [Data]                 | = | Refer to JIS or Shift JIS Kanji code table                                                                                                                                                                                                                                                                                                                        |

[Coding example] HEX character letters of Shift JIS, horizontal expansion factor: 3, vertical expansion factor: 5

```
<A>
<V>100<H>200<P>2<L>0305
<K9>H8A948EAE89EF8ED0BBC42D
<Q>2
<Z>
```

[Notes]

- |                                         |   |                                                      |
|-----------------------------------------|---|------------------------------------------------------|
| 1. HEX characters                       | = | Kanji Code 4 bytes ASCII / 1 Kanji character         |
| 2. Binary code                          | = | Kanji Code 2 bytes / 1 Kanji character               |
| 3. Smoothing function validity range    | = | Horizontal/vertical validity range : factor 3 and 12 |
| 4. Highlighting function validity range | = | Horizontal/vertical validity range : factor 1 and 5  |

[Tips]

1. With the highlighting function, the character width enlarges proportional with the expansion factor.
2. Using the highlighting function, in some cases, depending on the type of font, characters become squeezed.
3. This command can only be used with Shift JIS character types.
4. For 1 byte character, the print is executed in 12×24 dot size.
5. For 2 bytes character, the print is executed in 24×24 dot size.
6. For half size character, the print is done, regardless of gothic Kanji settings <KG>, in Roman font.
7. For CT Series printers, the optional Kanji ROM is needed for using this command.

[Valid commands]

Print position	<V>	<H>							
Modification	<P>	<L>	<%>	<&>	</>	<0>	<WD>		



8.21 Font				
Available for				
	CT400/410/420	CT400-2/410-2/420-2	CT408i/412i/424i	
<b>16x16 dots vertically oriented Kanji (JIS or Shift JIS)</b>			<b>ESC+k1</b>	
Hexadecimal code	ESC	k1	Parameter	
	<1B>16	<6B>16<31>16	an~n	
Initial setting	None			

Persistence of the command	When printer is powered off	Set parameter will not be retained
	Validity in a job	Becomes invalid after execution
	Validity after a job	Becomes invalid after the job

[Function]

Specifies W16 x H16 dot vertical written Kanji characters

[Format]

<k1>an~n

• Parameter

a [Kanji selection mode] = H : HEX characters  
 B : Binary code  
 I : HEX characters with smoothing function  
 C : Binary code with smoothing function  
 J : HEX characters with highlighting function  
 D : Binary code with highlighting function  
 K : HEX characters with smoothing and highlighting functions  
 E : Binary characters with smoothing and highlighting functions

n [Data] = Refer to JIS or Shift JIS Kanji code table

[Coding example 1] HEX character letters of Shift JIS, horizontal expansion factor: 3, vertical expansion factor: 5

```
<A>
<V>100<H>200<P>2<L>0305
<k1>H81698A94816A83548367815B
<Q>2
<Z>
```

[Coding example 2] Binary code of JIS, horizontal expansion factor: 2, vertical expansion factor: 3

```
<A>
<V>100<H>200<P>2<L>0203
<k1>B!J3t!K%5%H!<
<Q>2
<Z>
```

[Notes]

1. HEX characters = Kanji Code 4 bytes ASCII / 1 Kanji character
2. Binary code = Kanji Code 2 bytes / 1 Kanji character
3. Smoothing function validity range = Horizontal/vertical validity range : factor 3 and 12
4. Highlighting function validity range = Horizontal/vertical validity range : factor 1 and 5

[Tips]

1. With the highlighting function, the character width enlarges proportional with the expansion factor.
2. Using the highlighting function, in some cases, depending on the type of font, characters become squeezed.
3. For CT Series printers, the optional Kanji ROM is needed for using this command.

[Valid commands]

Print position	<V>	<H>								
Modification	<P>	<L>	<%>	<&>	</>	<0>	<WD>			

## 8.22 Font

Available for	CT400/410/420	CT400-2/410-2/420-2	CT408i/412i/424i
<b>24x24 dots vertically oriented Kanji (JIS or Shift JIS)</b>			<b>ESC+k2</b>
Hexadecimal code	ESC <1B> <sub>16</sub>	k2 <6B> <sub>16</sub> <32> <sub>16</sub>	Parameter an~n
Initial setting	None		

Persistence of the command	When printer is powered off	Set parameter will not be retained
	Validity in a job	Becomes invalid after execution
	Validity after a job	Becomes invalid after the job

### [Function]

Specifies W24 x H24 dot vertical written Kanji characters

### [Format]

<k2>an~n

#### • Parameter

a [Kanji selection mode] = H : HEX characters  
 B : Binary code  
 I : HEX characters with smoothing function  
 C : Binary code with smoothing function  
 J : HEX characters with highlighting function  
 D : Binary code with highlighting function  
 K : HEX characters with smoothing and highlighting functions  
 E : Binary characters with smoothing and highlighting functions

n [Data] = Refer to JIS or Shift JIS Kanji code table

[Coding example 1] HEX character letters of Shift JIS, horizontal expansion factor: 3, vertical expansion factor: 5

```
<A>
<V>100<H>200<P>2<L>0305
<k2>H81698A94816A83548367815B
<Q>2
<Z>
```

[Coding example 2] Binary code of JIS, horizontal expansion factor: 2, vertical expansion factor: 3

```
<A>
<V>100<H>200<P>2<L>0203
<k2>B!J3t!K%5%H!<
<Q>2
<Z>
```

### [Notes]

1. HEX characters = Kanji Code 4 bytes ASCII / 1 Kanji character
2. Binary code = Kanji Code 2 bytes / 1 Kanji character
3. Smoothing function validity range = Horizontal/vertical validity range : factor 3 and 12
4. Highlighting function validity range = Horizontal/vertical validity range : factor 1 and 5

### [Tips]

1. With the highlighting function, the character width enlarges proportional with the expansion factor.
2. Using the highlighting function, in some cases, depending on the type of font, characters become squeezed.
3. For CT Series printers, the optional Kanji ROM is needed for using this command.

### [Valid commands]

Print position	<V>	<H>	<P>	<L>	<Q>	<Z>	<WD>			
Modification	<P>	<L>	<%>	<&>	</>	<0>	<WD>			

8.23 Font				
Available for				
	CT400/410	CT400-2/410-2	CT408i/412i	CT420/CT420-2/CT424i
<b>22x22 dots vertically oriented Kanji (JIS or Shift JIS)</b>			<b>ESC+k3</b>	
Hexadecimal code	ESC <1B> <sub>16</sub>	k3 <6B> <sub>16</sub> <33> <sub>16</sub>	Parameter an~n	
Initial setting	None			

Persistence of the command	When printer is powered off	Set parameter will not be retained
	Validity in a job	Becomes invalid after execution
	Validity after a job	Becomes invalid after the job

[Function]

Specifies W22 x H22 dot vertical written Kanji characters

[Format]

<k3>an~n

• Parameter

a [Kanji selection mode] = H : HEX characters  
 B : Binary code  
 I : HEX characters with smoothing function  
 C : Binary code with smoothing function  
 J : HEX characters with highlighting function  
 D : Binary code with highlighting function  
 K : HEX characters with smoothing and highlighting functions  
 E : Binary characters with smoothing and highlighting functions

n [Data] = Refer to JIS or Shift JIS Kanji code table

[Coding example 1] HEX character letters of Shift JIS, horizontal expansion factor: 3, vertical expansion factor: 5

```
<A>
<V>100<H>200<P>2<L>0305
<k3>H81698A94816A83548367815B
<Q>2
<Z>
```

[Coding example 2] Binary code of JIS, horizontal expansion factor: 2, vertical expansion factor: 3

```
<A>
<V>100<H>200<P>2<L>0203
<k3>B!J3t!K%5%H!<
<Q>2
<Z>
```

[Notes]

1. HEX characters = Kanji Code 4 bytes ASCII / 1 Kanji character
2. Binary code = Kanji Code 2 bytes / 1 Kanji character
3. Smoothing function validity range = Horizontal/vertical validity range : factor 3 and 12
4. Highlighting function validity range = Horizontal/vertical validity range : factor 1 and 5

[Tips]

1. With the highlighting function, the character width enlarges proportional with the expansion factor.
2. Using the highlighting function, in some cases, depending on the type of font, characters become squeezed.
3. For CT Series printers, the optional Kanji ROM is needed for using this command.
4. This command is not available for CT420/420-2/424i printers.

[Valid commands]

Print position	<V>	<H>								
Modification	<P>	<L>	<%>	<&>	</>	<0>	<WD>			

## 8.24 Font

Available for	CT400/410/420	CT400-2/410-2/420-2	CT408i/412i/424i
<b>16×16 dots vertically oriented Kanji with 1-byte character (Shift JIS only)</b>			<b>ESC+k8</b>
Hexadecimal code	ESC <1B> <sub>16</sub>	k8 <6B> <sub>16</sub> <38> <sub>16</sub>	Parameter an~n
Initial setting	None		

Persistence of the command	When printer is powered off	Set parameter will not be retained
	Validity in a job	Becomes invalid after execution
	Validity after a job	Becomes invalid after the job

### [Function]

Prints W16 x H16 dot vertical written Kanji characters and W8 x H16 dot, 1 byte vertical written characters

### [Format]

<k8>an~n

#### • Parameter

a [Kanji selection mode] = H : HEX characters  
 B : Binary code  
 I : HEX characters with smoothing function  
 C : Binary code with smoothing function  
 J : HEX characters with highlighting function  
 D : Binary code with highlighting function  
 K : HEX characters with smoothing and highlighting functions  
 E : Binary characters with smoothing and highlighting functions

n [Data] = Refer to JIS or Shift JIS Kanji code table

[Coding example] HEX character letters of Shift JIS, horizontal expansion factor: 3, vertical expansion factor: 5

```
<A>
<V>100<H>200<P>2<L>0305
<k8>H8A948EAE89EF8ED0BBC42D
<Q>2
<Z>
```

### [Notes]

1. HEX characters = Kanji Code 4 bytes ASCII / 1 Kanji character
2. Binary code = Kanji Code 2 bytes / 1 Kanji character
3. Smoothing function validity range = Horizontal/vertical validity range : factor 3 and 12
4. Highlighting function validity range = Horizontal/vertical validity range : factor 1 and 5

### [Tips]

1. With the highlighting function, the character width enlarges proportional with the expansion factor.
2. Using the highlighting function, in some cases, depending on the type of font, characters become squeezed.
3. This command can only be used with Shift JIS character types.
4. For 1 byte character, the print is executed in 8×16 dot size.
5. For 2 bytes character, the print is executed in 16×16 dot size.
6. For half size character, the print is done, regardless of gothic Kanji settings, in roman font.
7. For CT Series printers, the optional Kanji ROM is needed for using this command.

### [Important]

1. If having selected the half width mode and printing voiced consonant marks, this marks will be printed separately from the character itself. For example: When specifying [ʌʌ], it will be separated in three parts.

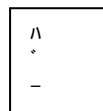

### [Valid commands]

Print position	<V>	<H>							
Modification	<P>	<L>	<%>	<&>	</>	<0>	<WD>		

8.25 Font			
Available for	CT400/410/420	CT400-2/410-2/420-2	CT408i/412i/424i
24×24 dots vertically oriented Kanji with 1-byte character (Shift JIS only)			ESC+k9
Hexadecimal code	ESC <1B> <sub>16</sub>	k9 <6B> <sub>16</sub> <39> <sub>16</sub>	Parameter an~n
Initial setting	None		

Persistence of the command	When printer is powered off	Set parameter will not be retained
	Validity in a job	Becomes invalid after execution
	Validity after a job	Becomes invalid after the job

[Function]

Prints W24 x H24 dot vertical written Kanji characters and W12 x H24 dot, 1 byte vertical written characters.

[Format]

<k9>an~n

• Parameter

a [Kanji selection mode] = H : HEX characters  
 B : Binary code  
 I : HEX characters with smoothing function  
 C : Binary code with smoothing function  
 J : HEX characters with highlighting function  
 D : Binary code with highlighting function  
 K : HEX characters with smoothing and highlighting functions  
 E : Binary characters with smoothing and highlighting functions

n [Data] = Refer to JIS or Shift JIS Kanji code table

[Coding example] HEX character letters of Shift JIS, horizontal expansion factor: 3, vertical expansion factor: 5

```
<A>
<V>100<H>200<P>2<L>0305
<k9>H8A948EAE89EF8ED0BBC42D
<Q>2
<Z>
```

[Notes]

1. HEX characters = Kanji Code 4 bytes ASCII / 1 Kanji character
2. Binary code = Kanji Code 2 bytes / 1 Kanji character
3. Smoothing function validity range = Horizontal/vertical validity range : factor 3 and 12
4. Highlighting function validity range = Horizontal/vertical validity range : factor 1 and 5

[Tips]

1. With the highlighting function, the character width enlarges proportional with the expansion factor.
2. Using the highlighting function, in some cases, depending on the type of font, characters become squeezed.
3. This command can only be used with Shift JIS character types.
4. For 1 byte character, the print is executed in 12×24 dot size.
5. For 2 bytes character, the print is executed in 24×24 dot size.
6. For half size character, the print is done, regardless of gothic Kanji settings, in roman font.
7. For CT Series printers, the optional Kanji ROM is needed for using this command.

[Important]

1. If having selected the half width mode and printing voiced consonant marks, this marks will be printed separately from the character itself. For example: When specifying [h<sup>^</sup>], it will be separated in three parts.

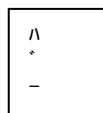

[Valid commands]

Print position	<V>	<H>								
Modification	<P>	<L>	<%>	<&>	</>	<0>	<WD>			

## 8.26 Font

Available for	CT400/410/420	CT400-2/410-2/420-2	CT408i/412i/424i
<b>Registration of 16x16 dots external character</b>			<b>ESC+T1</b>
Hexadecimal code	ESC <1B> <sub>16</sub>	T1 <54> <sub>16</sub> <31> <sub>16</sub>	Parameter abbn~n
Initial setting	None		

Persistence of the command	When printer is powered off	Set parameter will not be retained
	Validity in a job	Becomes invalid after execution
	Validity after a job	Becomes invalid after the job

### [Function]

Stores external character of W16 x H16 dots

### [Format]

<T1>abbn~n

#### • Parameter

a [Select type of data to be stored] = H : HEX characters  
B : Binary code characters

b [Font code address to be registered]

<JIS code>

H : Max. 95 letters in the range of 21 and 7F

B : Max. 95 letters in the range of 21H and 7FH

<Shift JIS>

H : Max. 95 letters in the range of 40 and 9E

B : Max. 95 letters in the range of 40H and 9EH

n [Data to be stored]

### [Coding example 1] HEX character letters of JIS code

<A>

<T1>H21

00FF-----FF00

<Z>

<A>

<V>100<H>200<K1>H9021

<Q>2

<Z>

### [Coding example 2] Registered data by binary code of Shift JIS

<A>

<T1>B<40><sub>16</sub>

<00FF-----FF00><sub>16</sub>

<Z>

<A>

<V>100<H>200<K1>B<F0><sub>16</sub><40><sub>16</sub>

<Q>2

<Z>

[Notes]

1. Saves non external fonts of W16 x H16 size to the internal memory
2. Concerning the font code address to be registered, specify a font according to the [Kanji code mode] of the printer- JIS code or Shift JIS code.
3. Data can be rewritten
4. Data registration is done according to the schematic below
5. If storing the data to the printer memory, the data will be lost when the power supply is turned off. In such cases, register the data again.

External characters file [16×16]

D1	D2
D3	D4
D5	D6
.	.
.	.
.	.
D31	D32

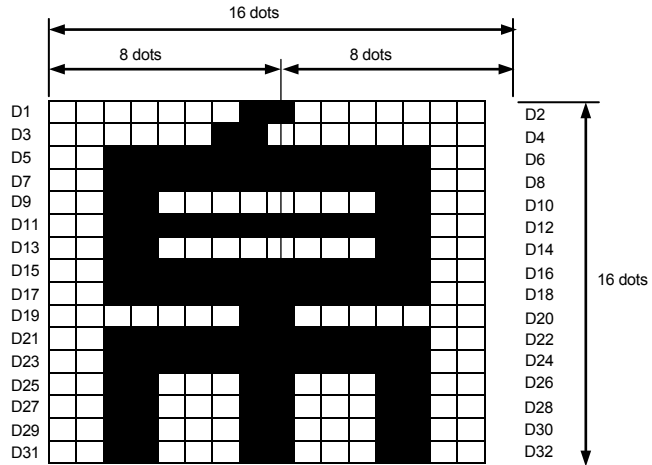

D1 and D2 are specified reversed. For putting in data according to the schematic above, D1 has to be set to [00000001] while D2 has to be set to [10000000]. In HEX this <01><sub>16</sub> for D1 and <80><sub>16</sub> for D2.

The same applies to all odd and even numbers up to D32.

D3: <03><sub>16</sub>, D4: <00><sub>16</sub>, D5: <3F><sub>16</sub>, D6: <FC><sub>16</sub>,... D32: <018003003FFC.....>

8.27 Font			
Available for	CT400/410/420	CT400-2/410-2/420-2	CT408i/412i/424i
Registration of 24x24 dots external character			ESC+T2
Hexadecimal code	ESC <1B> <sub>16</sub>	T2 <54> <sub>16</sub> <32> <sub>16</sub>	Parameter Abbn~n
Initial setting	None		

Persistence of the command	When printer is powered off	Set parameter will not be retained
	Validity in a job	Becomes invalid after execution
	Validity after a job	Becomes invalid after the job

[Function]

Stores external character of W24 x H24 dots

[Format]

<T2>abbn - n

• Parameter

a [Select type of data to be stored] = H : HEX characters  
B : Binary code characters

b [Font code address to be registered]

<JIS code>

H : Max. 95 letters in the range of 21 and 7F  
B : Max. 95 letters in the range of 21H and 7FH

<Shift JIS>

H : Max. 95 letters in the range of 40 and 9E  
B : Max. 95 letters in the range of 40H and 9EH

n [Data to be stored]

[Coding example 1] HEX character letters of JIS code

```
<A>
<T2>H21
00FF.....FF00
<Z>
```

```
<A>
<V>100 <H>200 <K2>H9021
<Q>2
<Z>
```

[Coding example 2] Registered data by binary code of Shift JIS

```
<A>
<T2>B<40>16
00FF.....FF00
<Z>
```

```
<A>
<V>100 <H>200 <K2>B<F0>16<40>16
<Q>2
<Z>
```



[Notes]

1. Saves external fonts of W24 x H24 size to the internal memory
2. Concerning the font code address to be registered, specify a font according to the [Kanji code mode] of the printer- JIS code or Shift JIS code.
3. Data can be rewritten
4. Data registration is done according to the schematic below
5. If storing the data to the printer memory, the data will be lost when the power supply is turned off. In such cases register the data another time.

External character file [24×24]

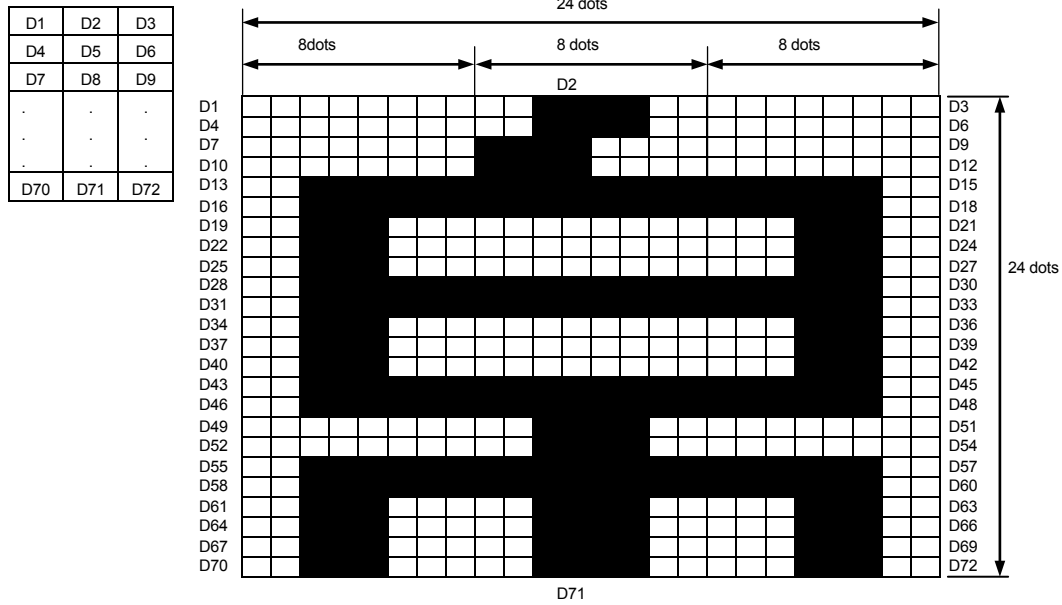

For putting in data according to the schematic above, D1 has to be set to [00000000], D2 has to be set to [00111100] and D3 to [00000000]. In HEX this <00><sub>16</sub> for D1 and <3C><sub>16</sub> for D2 and <00><sub>16</sub> for D3.

The same principle applies to all numbers up to D72.

D4: <00><sub>16</sub>, D5: <3C><sub>16</sub>, D6: <00><sub>16</sub>, D6: <FC><sub>16</sub>,... D72: <003C00003C00.....>

8.28 Font				
Available for				
	CT400/410/420	CT400-2/410-2/420-2	CT408/412/424i	
Calling horizontally oriented external character			ESC+K1(K2)	
Hexadecimal code	ESC	K1 (K2)	Parameter	
	<1B> <sub>16</sub>	<4B> <sub>16</sub> <31> <sub>16</sub> (<4B> <sub>16</sub> <32> <sub>16</sub> )	ab~b	
Initial setting	None			
Persistence of the command	When printer is powered off		Set parameter will not be retained	
	Validity in a job		Becomes invalid after execution	
	Validity after a job		Becomes invalid after the job	

[Function]

Invokes horizontal external characters saved in the printer memory to print out

[Format]

<K1>ab - b

<K2>ab - b

• Parameter

a [Print specification] = H : HEX characters  
 B : Binary code  
 I : HEX characters with smoothing function  
 C : Binary code with smoothing function  
 J : HEX characters with highlighting function  
 D : Binary code with highlighting function  
 K : HEX characters with smoothing and highlighting functions  
 E : Binary characters with smoothing and highlighting functions

b [Registration code] <JIS code>  
 H, I, J, K : 9021 to 907F  
 B, C, D, E : 9021H to 907FH  
 <Shift JIS code>  
 H, I, J, K : F040 to F09E  
 B, C, D, E : F040H to F09EH

[Coding example 1] Invokes 16x16 dots external character; Registered data by HEX character of JIS

```
<A>
<T1>H21
00FF..... FF00
<Z>

<A>
<V>100<H>200<K1>H9021
<Q>2
<Z>
```

[Coding example 2] Invokes 24x24 dots external character; Registered data by binary code of Shift JIS

```
<A>
<T2>B<40>16
00FF..... FF00
<Z>

<A>
<V>100<H>200<K2>B<F0>16<40>16
<Q>2
<Z>
```

[Notes]

1. If the print out is not executed properly, register the data another time.
2. Applicable range of smoothing function = horizontal/vertical range: factor 3 to 12
3. Applicable range of highlighting function = horizontal/vertical range: factor 1 to 5

[Tips]

1. With the highlighting function, the character width enlarges proportional with the expansion factor.
2. Using the highlighting function, in some cases, depending on the type of font, characters become squeezed.

[Valid commands]

Print position	<V>	<H>								
Modification	<P>	<L>	<%>	<&>	</>	<0>	<WD>			

8.29 Font				
Available for				
	CT400/410/420	CT400-2/410-2/420-2	CT408/412/424i	
Calling vertically oriented external character			ESC+k1(k2)	
Hexadecimal code	ESC	k1 (k2)	Parameter	
	<1B> <sub>16</sub>	<6B> <sub>16</sub> <31> <sub>16</sub> (<6B> <sub>16</sub> <32> <sub>16</sub> )	ab~b	
Initial setting	None			
Persistence of the command	When printer is powered off		Set parameter will not be retained	
	Validity in a job		Becomes invalid after execution	
	Validity after a job		Becomes invalid after the job	

[Function]

Invokes vertical external characters saved in the printer memory to print out

[Format]

<k1>abbn~n

<k2>abbn~n

a [Print specification] = H : HEX characters  
 B : Binary code  
 I : HEX characters with smoothing function  
 C : Binary code with smoothing function  
 J : HEX characters with highlighting function  
 D : Binary code with highlighting function  
 K : HEX characters with smoothing and highlighting functions  
 E : Binary characters with smoothing and highlighting functions

b [Registration code] <JIS code>  
 H, I, J, K : 9021 to 907F  
 B, C, D, E : 9021H to 907FH  
 <Shift JIS code>  
 H, I, J, K : F040 - F09E  
 B, C, D, E : F040H - F09EH

[Coding example 1] Invokes 16x16 dots external character; Registered data by HEX characters of JIS

```
<A>
<T1>H21
00FF..... FF00
<Z>

<A>
<V>100<H>200<k1>H9021
<Q>2
<Z>
```

[Coding example 2] Invokes 24x24 dots external character; Registered data by binary code of Shift JIS

```
<A>
<T2>B<40>16
00FF..... FF00
<Z>

<A>
<V>100<H>200<k2>B<F0>16<40>16
<Q>2
<Z>
```

[Notes]

1. If the print out is not executed properly, register the data another time.
2. Applicable range of smoothing function = horizontal/vertical range: factor 3 - 12
3. Applicable range of focusing function = horizontal/vertical range: factor 1 - 5

[Tips]

1. With the focus function the character width enlarges proportional with the expansion factor.
2. Using the focus function, in some cases, depending on the type of font, characters become squeezed.

[Valid commands]

Print position	<V>	<H>								
Modification	<P>	<L>	<%>	<&>	<I>	<O>	<WD>			

## 9 Barcode setting outline

The barcode setting is done by inputting the relevant parameter for B, D, BD after pressing ESC. This enables the selection of the barcode type, the barcode ratio and the print out of guard bars or translation etc.

Please carefully study the next 3 pages for barcode setting specifications.

Please find the description of parameters B, D, BD below.

[Barcode ratio]

Parameter	Barcode	<B>	<D>	<BD>
0	CODABAR(NW-7)	1 : 3	1 : 2	2 : 5
1	CODE39	1 : 3	1 : 2	2 : 5
2	ITF	1 : 3	1 : 2	2 : 5
5	Industrial 2of5	1 : 3	1 : 2	2 : 5
6	Matrix 2of5	1 : 3	1 : 2	2 : 5

### (1) Barcode ratio

Barcodes consist of narrow bars, wide bars, narrow spaces and wide spaces. The barcode ratio is specified as the ratio between one wide bar and one narrow bar.

Barcode ratio: Parameter <B>, Ratio: 1:3

Narrow bar width [1] stands against wide bar width [3]

Barcode ratio: Parameter <D>, Ratio: 1:2

Narrow bar width [1] stands against wide bar width [2]

Barcode ratio: Parameter <BD>, Ratio: 2:5

Narrow bar width [2] stands against wide bar width [5]

If an other barcode ratio shall be chosen, this can be done by specifying an user-defined ratio, using command <BT> and printing that registered ratio by command <BW>.

### (2) Narrow bar width and barcode height

The width of the narrow bar is set through the thickness of the bar. The barcode height is set by the height of the bar.

For example, if printing a narrow bar with a width of 1 dot with a print head of 12 dots/mm (305dpi) the width of the narrow bar will be 0.083 mm, which could cause problems when reading the barcode with a scanner. Setting the narrow bar width to 2 dots (0.166 mm) will enable a troublefree reading by the barcode scanner.

When specifying the narrow bar it is necessary to consider the print head density and the ability of the barcode scanner.

The barcode ratio and the width of the narrow bar specify the actual thickness of the bar.

For example: Barcode ratio 1:3. Narrow bar width: 3 dots. The actual barcode ratio (in dots) will be 3:9.

The Barcode height shall be adjusted to the specifications of the barcode scanner.

### (3) Inter-character gap

The inter-character gap is the space between each barcode characters.

The inter-character gap shall be put in directly in front of the barcode ratio parameters <B>, <D>, <BD> or in front of the printing command for user specified ratios <BW>. The inter-character gap is set by command <P>. If no gap is specified, the initial value of 2 dots is chosen.

Barcodes which allow the specification of an inter-character gap are as follows:

- 1) CODABAR(NW-7)
- 2) CODE39
- 3) Industrial 2of5
- 4) Matrix 2of5

The actual inter-character gap is specified by the multiplication of the character pitch <P> and the width of the narrow bar.

For example: Inter-character pitch <P>: 3, Narrow bar width: 2 dots

$$\text{Inter-character gap} = 3 \times 2 = 6 \text{ dots}$$

**(4) Guard bars and translation**

For UPC-A, JAN/EAN8/13 column barcodes it is possible to specify the print of guard bars, translation.

Parameter	Barcode	Parameter <B>	Parameter <D>	Parameter <BD>
3	JAN/EAN13	Desc.Lett. OFF Guardbar OFF	Desc.Lett. OFF Guardbar ON	Desc.Lett. ON Guardbar ON
4	JAN/EAN8	Desc.Lett. OFF Guardbar OFF	Desc.Lett. OFF Guardbar ON	Desc.Lett. ON Guardbar ON
H	UPC-A	Desc.Lett. OFF Guardbar OFF	Desc.Lett. OFF Guardbar ON	Desc.Lett. ON Guardbar ON

**1) When selecting <B> (Translation: OFF, Guard bars: OFF)**



**2) When selecting <D> (Translation: OFF, Guard bars: ON)**

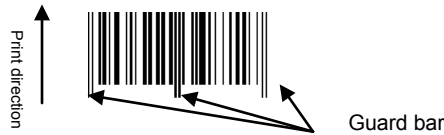

[Notes] After having set the guard bars it is possible to specify the font for the translation.  
Refer to barcode specifications (Translation font selection) <D> - <d>.

**3) When selecting <BD> selected (Translation: ON, Guard bars: ON)**

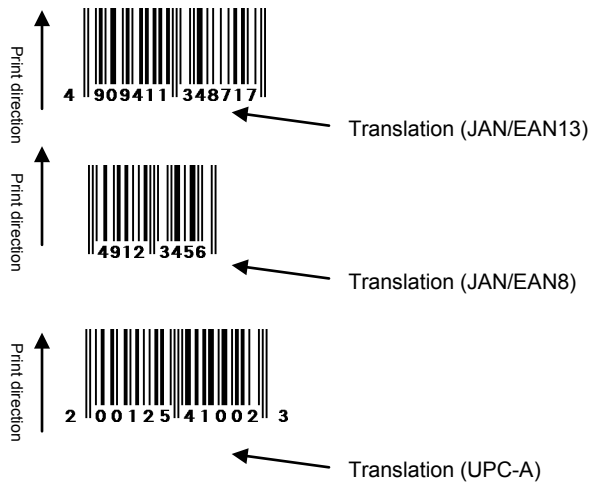

[Specifying barcode only]

Parameter	Barcode	Parameter <B>
C	CODE93	Barcode only
E	UPC-E	Barcode only
G	CODE128	Barcode only
I	Normal carton ID specific GS1-128(UCC/EAN128)	Barcode only
Z	Customized barcode	Barcode only

[Important]

1. These barcodes have no specification such as barcode ratio and translation.

**(5) Check digits**

Check digits available for each type of barcode are listed below.

[C/D]

Parameter	Barcode	Input columns	Columns printed, information included
3	JAN/EAN13	12	13 columns (barcode input+C/D) Calculation of C/D is done in modulus 10 (automatic)
		13	13 columns (Complying to barcode input. C/D is not executed/printed)
4	JAN/EAN8	7	8 columns (barcode input+C/D) Calculation of C/D is done in modulus 10 (automatic)
		8	8 columns (Complying to barcode input. C/D is not executed/printed)
C	CODE93	Max. 99	Calculation of C/D is done in modulus 47 (automatic)
E	UPC-E	6 (fix)	Calculation of C/D is done in modulus 10 (automatic)
G	CODE128	-	Calculation of C/D is done in modulus 103 (automatic)
H	UPC-A	11 (fix)	12 columns (barcode input+C/D) Calculation of C/D is done in modulus 10 (automatic)
I	Normal carton ID specific GS1-128(UCC/EAN128)	17 (fix)	Calculation of C/D is done in modulus 103 (automatic)

\* C/D stands for check digits

**Barcode orientation**

Print direction of barcodes can be changed. However, if having selected serial 1 or serial 2, depending on the expansion factor, the barcode print might be blurred.

- Parallel 1 : Forward printing
- Parallel 2 : Rotating 180° in respect to parallel 1
- Serial 1 : Rotating 90° in respect to parallel 1
- Serial 2 : Rotating 270° in respect to parallel 1

**\* Forward printing: picket fence barcode**

- 1) If printing in parallel 1 or parallel 2 mode, specify the bar width expansion factor so that when using a 8 dots/mm or 12 dots/mm head the width of the narrow bar is at least 2 dots and when using a 23.6 dots/mm head the width of the narrow bar is at least 4 dots. (L shows the applicable expansion factor in relevance to the bar ratio)

	Head density		
	8 dots/mm	12 dots/mm	23.6 dots/mm
Bar ratio 1:2	More than 2L	More than 2L	More than 4L
Bar ratio 1:3	More than 2L	More than 2L	More than 4L
Bar ratio 2:5	More than 1L	More than 1L	More than 2L
UPC-A/JAN/EAN	More than 2L	More than 2L	More than 4L

- 2) If printing in serial 1 or serial 2 mode, specify the bar width expansion factor so that when using a 8 dots/mm or 12 dots/mm head the width of the narrow bar is at least 3 dots and when using a 23.6 dots/mm head the width of the narrow bar is at least 6 dots.

- 3) If printing in serial 1 or serial 2 mode, reduce the printing speed

	Head density		
	8 dots/mm	12 dots/mm	23.6 dots/mm
Bar ratio 1:2	More than 3L	More than 3L	More than 6L
Bar ratio 1:3	More than 3L	More than 3L	More than 6L
Bar ratio 2:5	More than 2L	More than 2L	More than 4L
UPC-A/JAN/EAN	More than 3L	More than 3L	More than 6L

9.1 Barcode			
Available for	CT400/410/420	CT400-2/410-2/420-2	CT408/412/424i
<b>Barcode setting (Ratio 1:3)</b>		<b>ESC+B</b>	
Hexadecimal code	ESC <1B> <sub>16</sub>	B <42> <sub>16</sub>	Parameter abbcccn~n
Initial setting	None		
Persistence of the command	When printer is powered off	Set parameter will not be retained	
	Validity in a job	Becomes invalid after execution	
	Validity after a job	Becomes invalid after the job	

[Function]

Specifies a barcode with a ratio of 1:3 between narrow bar and wide bar.

[Format]

<B>abbcccn~n

• Parameter

a	[Barcode type]	=	Refer to table below
b	[Narrow bar width]	=	Valid range : 01 to 12 dots
c	[Barcode height]	=	Valid range : 001 to 999 dots
n	[Print data]	=	Data

Barcode type (Depending on the barcode type, there might be the case that there is no ratio specified for the module draw up)

a	Barcode type	Information	Ratio
0	CODABAR(NW-7)	Always include start and stop characters in print data. Start/stop characters are [A, B, C, D, E, N, T, a, b, c, d, e, n, t] Example) In case of barcode data [123]: [A123A] Inter-character pitch of barcode is valid. For print data specifications refer to table of CODABAR(NW-7) code	1:3
1	CODE39	Always include start and stop characters in print data. Start/stop characters are [*] Example) In case of barcode data [12345]: [*12345*] Inter-character pitch of barcode is valid. For print data specifications refer to table of CODE39 code	1:3
2	ITF	Put the print data in even number columns If putting the print data in odd number columns "0" will be shown on the head of the print data. For print data specifications refer to table of ITF code	1:3
3	JAN/EAN13	This barcode does not include guard bars or translation For print data specifications refer to table of Interleaved JAN/EAN13 code	Fixed
4	JAN/EAN8	This barcode does not include guard bars or translation For print data specifications refer to table of Interleaved JAN/EAN8 code	Fixed
5	Industrial 2of5	Inter-character pitch of the barcode is valid. For print data specifications refer to table of Industrial 2of5 code	1:3
6	Matrix 2of5	Inter-character pitch of the barcode is valid For print data specifications refer to table of Matrix 2of5 code	1:3
A *1	MSI	Print data input is possible for up to 13 characters For print data specifications refer to table of MSI code	Fixed
C	CODE93	Refer to CODE93 specifications <BC>	Fixed
E	UPC-E	Print data input is possible for up to 63 characters For print data specifications refer to table of UPC-E code	Fixed
F *1	Bookland	Refer to Bookland specifications <BF>	Fixed
G	CODE128	Refer to CODE128 specifications <BG>	Fixed
H	UPC-A	This barcode does not include guard bars or translation For print data specifications refer to table of Interleaved UPC-A code	Fixed
I	GS1-128(UCC/EAN128)	Refer to GS1-128(UCC/EAN128) specifications <BI>	Fixed
P *1	Postnet	Refer to Postnet specifications <BP>	Fixed

\*1 Only available for CT Series.

[Coding example 1] Barcode type: CODE39, Narrow bar width: 03, Barcode height: 120, Print data: \*1234AB\*  
 <A>  
 <V>100<H>100<B>103120\*1234AB\*  
 <Q>2  
 <Z>

[Coding example 2] Barcode type: JAN8, Narrow width: 02, Barcode height: 080, Print data: 4912345  
 <A>  
 <V>100<H>100<B>4020804912345  
 <Q>2  
 <Z>

[Notes]

- The inter-character pitch of the barcode is valid at CODABAR(NW-7), CODE39, Industrial 2of5 and Matrix 2of5. The barcode inter-character pitch is set by specifying the character pitch <P> immediately before. If not set, the inter-character pitch will be of the same size as a space command.
- |                                                     |   |                             |                                |
|-----------------------------------------------------|---|-----------------------------|--------------------------------|
| Example) Inter-letter pitch (Not specified / 0 / 1) | x | Narrow bar width (2 dots) = | Inter-character pitch (2 dots) |
| Inter-letter pitch (2)                              | x | Narrow bar width (3 dots) = | Inter-character pitch (6 dots) |

[Tips]

- If a value outside of the valid range is set, a command error occurs and the print out is not executed.
- Widening the narrow bar width, can result in falling out of the printing range.
- When using a barcode that allows the specification of the inter-character pitch, and specifying a large character pitch <P>, it might happen that the barcode scanner is unable to read the information properly. Enlarging the narrow bar width can result in reduced readability of the barcode. Always confirm the specifications of the barcode scanner before changing those values.
- Adjust the narrow bar so that the barcode is easily readable by the barcode scanner (refer to the specifications of the scanner).
- If the barcode is still not readable, lower the print speed <CS> or adjust the print darkness <#E>.
- When using codes like the CODABAR(NW-7), CODE39 include a start / stop character because otherwise the print is executed, but the scanner will not be able to read the data.
- When using JAN/EAN13, JAN/EAN8 codes, and including a C/D in the print data, be sure to calculate the value right. If the C/D value is not right, the print is executed, but the scanner will not be able to read the data.



9.2 Barcode			
Available for	CT400/410/420	CT400-2/410-2/420-2	CT408/412/424
<b>Barcode setting (Ratio 1:2)</b>		<b>ESC+D</b>	
Hexadecimal code	ESC <1B> <sub>16</sub>	D <44> <sub>16</sub>	Parameter abbcccn~n
Initial setting	None		
Persistence of the command	When printer is powered off	Set parameter will not be retained	
	Validity in a job	Becomes invalid after execution	
	Validity after a job	Becomes invalid after the job	

[Function]

Specifies a barcode with a ratio of 1:2 between narrow bar and wide bar.

[Format]

<D>abbcccn~n

• Parameter

a	[Barcode type]	=	Refer to table below
b	[Narrow bar width]	=	01 to 12 dots
c	[Barcode height]	=	001 to 999 dots
n	[Print data]	=	Data

Barcode type (Depending on the barcode type, there might be the case that there is no ratio specified for the module draw up)

a	Barcode type	Information	Ratio
0	CODABAR(NW-7)	Always include start and stop characters in print data. Start/stop characters are [A, B, C, D, E, N, T, a, b, c, d, e, n, t] Example) In case of barcode data [123]: [A123A] Inter-character pitch of barcode is valid. For print data specifications refer to table of CODABAR(NW-7) code	1:2
1	CODE39	Always include start and stop characters in print data. Start/stop characters are [*] Example) In case of barcode data [12345]: [*12345*] Inter-character pitch of barcode is valid. For print data specifications refer to table of CODE39 code	1:2
2	ITF	Put the print data in even number columns If putting the print data in odd number columns "0" will be shown on the head of the print data. For print data specifications refer to table of ITF code	1:2
3	JAN/EAN13	This barcode does not include guard bars or translation For print data specifications refer to table of Interleaved JAN/EAN13 code	Fixed
4	JAN/EAN8	This barcode does not include guard bars or translation For print data specifications refer to table of Interleaved JAN/EAN8 code	Fixed
5	Industrial 2of5	Inter-character pitch of the barcode is valid. For print data specifications refer to table of Industrial 2of5 code	1:2
6	Matrix 2of5	Inter-character pitch of the barcode is valid For print data specifications refer to table of Matrix 2of5 code	1:2
H	UPC-A	This barcode does not include guard bars or translation For print data specifications refer to table of Interleaved UPC-A code	Fixed

[Coding example 1] Barcode type: CODABAR(NW-7), Narrow bar width: 03, Barcode height: 120, Print data: A1234A

<A>

<V>100<H>100<D>003120A1234A

<Q>2

<Z>

[Coding example 2] Barcode type: ITF, Narrow bar width: 04, Barcode height: 240, Print data: 98002345678163  
 <A>  
 <V>100<H>100<D>20424098002345678163  
 <Q>2  
 <Z>

[Coding example 3] Barcode type: UPC-A, Narrow bar width: 02, Barcode height: 120, Print data: 20123948573  
 <A>  
 <V>240<H>100<D>H0212020123948573  
 <Q>2  
 <Z>

[Notes]

- The inter-character pitch of the barcode is valid at CODABAR(NW-7), CODE39, Industrial 2of5 and Matrix 2of5. The barcode inter-character pitch is set by specifying the character pitch <P> immediately before. If not set, the inter-character pitch will be of the same size as a space command.
- |                                                     |   |                             |                                |
|-----------------------------------------------------|---|-----------------------------|--------------------------------|
| Example) Inter-letter pitch (Not specified / 0 / 1) | x | Narrow bar width (2 dots) = | Inter-character pitch (2 dots) |
| Inter-letter pitch (2)                              | x | Narrow bar width (3 dots) = | Inter-character pitch (6 dots) |

[Tips]

- If a value outside of the valid range is set, a command error occurs and the print out is not executed.
- Widening the narrow bar width, can result in falling out of the printing range.
- When using a barcode that allows the specification of the inter-character pitch, and specifying a large character pitch <P>, it might happen that the barcode scanner is unable to read the information properly. Enlarging the narrow bar width can result in reduced readability of the barcode. Always confirm the specifications of the barcode scanner before changing those values.
- Adjust the narrow bar so that the barcode is easily readable by the barcode scanner (refer to the specifications of the scanner).
- If the barcode is still not readable, lower the print speed <CS> or adjust the print darkness <#E>.
- When using codes like the CODABAR(NW-7), CODE39 include a start / stop character because otherwise the print is executed, but the scanner will not be able to read the data.
- When using JAN/EAN13, JAN/EAN8 codes, and including a C/D in the print data, be sure to calculate the value right. If the C/D value is not right, the print is executed, but the scanner will not be able to read the data.

9.3 Barcode			
Available for	CT400/410/420	CT400-2/410-2/420-2	CT408/412/424i
<b>Barcode translation setting</b>		<b>ESC+D ~ ESC+d</b>	
Hexadecimal code	ESC <1B> <sub>16</sub>	D~+ ESC+d <44> <sub>16</sub> ~<1B> <sub>16</sub> font type	Parameter abbcccn~n+<d>n~n
Initial setting	None		
Persistence of the command	When printer is powered off	Set parameter will not be retained	
	Validity in a job	Becomes invalid after execution	
	Validity after a job	Becomes invalid after the job	

[Function]

Specifies font type of barcode translation

[Format]

<D>abbcccn~n + <d>n~n

• Parameter

a	[Barcode type]	=	3	:	JAN/EAN13
			4	:	JAN/EAN8
			H	:	UPC-A
b	[Narrow bar width]	=	Valid range :		01 to 12 dots
c	[Barcode height]	=	Valid range :		001 to 999 dots
n	[Print data]	=	Barcode data		
d	[Font selection]	=	XU (Only valid for CT Series) XS (Only valid for CT Series) XM (Only valid for CT Series) XB (Only valid for CT Series) XL (Only valid for CT Series) OA OB		
n	[Print data]	=	Translation data		

[Coding example] Barcode type: JAN/EAN13, Narrow bar width: 02, Barcode height: 120,  
Barcode data: 4902471006795, Font type (of barcode translation): XS, Barcode translation: 4902471006795

```
<A>
<V>100<H>200<D>3021204902471006795
<XS>4902471006795
<Q>2
<Z>
```

[Notes]

1. Adds barcode translation in specified font.
2. If font is of non-specified type, it will not be printed. If the barcode expansion factor is very small, and the barcode translation font is large, there might occur overlaps of letters.
3. The print position of the barcode translation will be automatically determined by the printer.
4. The barcode translation of following codes will be restricted to conditions below: JAN/EAN8, JAN/EAN13, UPC-A
 

In case of 8 dots/mm (203dpi)	:	Narrow bar width has to be: [02], [03]
In case of 12 dots/mm (305dpi)	:	Narrow bar width has to be: [03], [04]
In case of 23.6 dots/mm (600dpi)	:	Narrow bar width has to be: [06], [07], [08]

9.4 Barcode			
Available for	CT400/410/420	CT400-2/410-2/420-2	CT408/412/424
<b>Barcode setting (Ratio 2:5)</b>		<b>ESC+BD</b>	
Hexadecimal code	ESC <1B> <sub>16</sub>	BD <42> <sub>16</sub> <44> <sub>16</sub>	Parameter abbcccn~n
Initial setting	None		

Persistence of the command	When printer is powered off	Set parameter will not be retained
	Validity in a job	Becomes invalid after execution
	Validity after a job	Becomes invalid after the job

[Function]

Specifies a barcode with a ratio of 2:5 between narrow bar and wide bar.

[Format]

<BD>abbcccn~n

• Parameter

a	[Barcode type]	=	Refer to table below
b	[Narrow bar width]	=	01 to 12 dots
c	[Barcode height]	=	001 to 999 dots
n	[Print data]	=	Data

Barcode type (Depending on the barcode type, there might be the case that there is no ratio specified for the module draw up)

a	Barcode type	Information	Ratio
0	CODABAR(NW-7)	Always include start and stop characters in print data. Start/stop characters are [A, B, C, D, E, N, T, a, b, c, d, e, n, t] Example) In case of barcode data [123]: [A123A] Inter-character pitch of barcode is valid. For print data specifications refer to table of CODABAR(NW-7) code	2:5
1	CODE39	Always include start and stop characters in print data. Start/stop characters are [*] Example) In case of barcode data [12345]: [*12345*] Inter-character pitch of barcode is valid. For print data specifications refer to table of CODE39 code	2:5
2	ITF	Put the print data in even number columns If putting the print data in odd number columns "0" will be shown on the head of the print data. For print data specifications refer to table of ITF code	2:5
3	JAN/EAN13	This barcode does not include guard bars or translation For print data specifications refer to table of Interleaved JAN/EAN13 code	Fixed
4	JAN/EAN8	This barcode does not include guard bars or translation For print data specifications refer to table of Interleaved JAN/EAN8 code	Fixed
5	Industrial 2of5	Inter-character pitch of the barcode is valid. For print data specifications refer to table of Industrial 2of5 code	2:5
6	Matrix 2of5	Inter-character pitch of the barcode is valid For print data specifications refer to table of Matrix 2of5 code	2:5
H	UPC-A	This barcode does not include guard bars or translation For print data specifications refer to table of Interleaved UPC-A code	Fixed

[Coding example1] Barcode type: CODABAR(NW-7), Narrow bar width: 03, Barcode height: 120, Print data: A1234A

<A>

<V>100<H>100<BD>003120A1234A

<Q>2

<Z>

[Coding example 2] Barcode type: ITF, Narrow bar width: 04, Barcode height: 240, Print data: 98002345678163  
 <A>  
 <V>100<H>100<BD>20424098002345678163  
 <Q>2  
 <Z>

[Coding example 3] Barcode type: UPC-A, Narrow bar width: 02, Barcode height: 120, Print data: 20123948573  
 <A>  
 <V>240<H>100<BD>H0212020123948573  
 <Q>2  
 <Z>

[Notes]

- For CODABAR(NW-7), CODE39, Industrial 2of5 and Matrix 2of5, the inter-character pitch of the barcode can be specified. The barcode inter-character pitch is set by specifying the character pitch <P> immediately before. If not set, the inter-character pitch will be of the same size as a space command.  
 Example) Inter-letter pitch (Not specified / 0 / 2) x Narrow bar width (2 dots) = Inter-character pitch (4 dots)  
           Inter-letter pitch (1) x Narrow bar width (3 dots) = Inter-character pitch (3 dots)  
           Inter-letter pitch (3) x Narrow bar width (3 dots) = Inter-character pitch (9 dots)
- The barcode translation of following codes will be restricted to conditions below: JAN/EAN8, JAN/EAN13, UPC-A  
     In case of 8 dots/mm (203dpi) : Narrow bar width has to be: [02], [03]  
     In case of 12 dots/mm (305dpi) : Narrow bar width has to be: [03], [04]  
     In case of 23.6 dots/mm (600dpi) : Narrow bar width has to be: [06], [07], [08]

[Tips]

- If a value outside of the valid range is set, a command error occurs and the print out is not executed.
- Widening the narrow bar width, can result in falling out of the printing range.
- When using a barcode that allows the specification of the inter-character pitch, and specifying a large character pitch <P>, it might happen that the barcode scanner is unable to read the information properly. Enlarging the narrow bar width can result in reduced readability of the barcode. Always confirm the specifications of the barcode scanner before changing those values.
- Adjust the narrow bar so that the barcode is easily readable by the barcode scanner (refer to the specifications of the scanner).
- If the barcode is still not readable, lower the print speed <CS> or adjust the print darkness <#E>.
- When using codes like the CODABAR(NW-7), CODE39 include a start / stop character because otherwise the print is executed, but the scanner will not be able to read the data.
- When using JAN/EAN13, JAN/EAN8 codes, and including a C/D in the print data, be sure to calculate the value right. If the C/D value is not right, the print is executed, but the scanner will not be able to read the data.

9.5 Barcode			
Available for	CT400/410/420	CT400-2/410-2/420-2	CT408i/412i/424i
Barcode ratio		ESC+BT	
Hexadecimal code	ESC <1B> <sub>16</sub>	BT <42> <sub>16</sub> <54> <sub>16</sub>	Parameter abbccddee
Initial setting	None		
Persistence of the command	When printer is powered off	Set parameter will not be retained	
	Validity in a job	Becomes invalid after execution	
	Validity after a job	Becomes invalid after the job	

[Function]

Specifies the ratio of the narrow gap in regard to the wide gap

[Format]

<BT>abbccddee

• Parameter

a	[Barcode type]	=	0	:	CODABAR(NW-7)
			1	:	CODE39
			2	:	ITF
			5	:	Industrial 2of5
			6	:	Matrix 2of5
b	[Narrow space]	=	Valid range	:	01 to 99 dots
c	[Wide space]	=	Valid range	:	01 to 99 dots
d	[Narrow bar]	=	Valid range	:	01 to 99 dots
e	[Wide bar]	=	Valid range	:	01 to 99 dots

[Coding example 1] Barcode type: CODE39, Narrow space: 03, Wide space: 06, Narrow bar: 03, Wide bar: 06

<A>

**<BT>103060306**

<V>100<H>200<BW>01233\*ABCD\*

<Q>2

<Z>

[Notes]

1. Barcodes with user specified ratios are printed by specifying the ratio (with this command) and having done that by commanding <BW>-barcode print according to specified ratio.
2. If the barcode print according to specified ratio <BW> and the define number of pages <Q> commands are not set, only the ratio of the narrow bar and the wide bar will be taken.
3. Only 1 registration at a time will be valid.
4. If selecting the data other than specified, a command error will occur and it will not be registered.

9.6 Barcode			
Available for	CT400/410/420	CT400-2/410-2/420-2	CT408/412/424i
<b>Barcode print by specified ratio</b>		<b>ESC+BW</b>	
Hexadecimal code	ESC <1B> <sub>16</sub>	BW <42> <sub>16</sub> <57> <sub>16</sub>	Parameter aabbbn~n
Initial setting	None		
Persistence of the command	When printer is powered off	Set parameter will not be retained	
	Validity in a job	Becomes invalid after execution	
	Validity after a job	Becomes invalid after the job	

[Function]

Specifies barcode ratio, saved by <BT>

[Format]

<BW>aabbbn~n

• Parameter

a [Narrow bar width] = Valid range : 01 to 12 dots  
 b [Barcode height] = Valid range : 001 to 999 dots  
 n [Print data] = Barcode data

[Coding example] Narrow bar width: 02, Barcode height: 120

```
<A>
<BT>103060306
<V>100<H>200<BW>02120*ABCD*
<Q>2
<Z>
```

[Notes]

- The inter-character pitch of the barcode is valid at CODABAR(NW-7), CODE39, Industrial 2of5 and Matrix 2of5. The barcode inter-character pitch is set by specifying the character pitch <P> immediately before. If not set, the inter-character pitch will be of the same size as a space command.  
 Example 1) Narrow space: 3 (specified with <BT> command)  
 Inter-letter pitch (Not specified/0/3) x Narrow bar width (2) = Inter-character pitch (6dots)  
 Example 2) Inter-letter pitch specified  
 Inter-letter pitch (2) x Narrow bar width (3) = Inter-character pitch (6dots)
- If not setting the barcode ratio according to <BT>, the print will be executed with the values for narrow bar, wide bar registered beforehand. If no values are registered, the print is not executed.
- For print data according to the barcode type, refer to the code tables of the relevant barcodes.

[Tips]

- If a value outside of the valid range is set, a command error occurs and the print out is not executed.
- Widening the narrow bar width, can result in falling out of the printing range.
- When using a barcode that allows the specification of the inter-character pitch, and specifying a large character pitch <P>, it might happen that the barcode scanner is unable to read the information properly. Enlarging the narrow bar width can result in reduced readability of the barcode. Always confirm the specifications of the barcode scanner before changing those values.
- Adjust the narrow bar so that the barcode is easily readable by the barcode scanner (refer to the specifications of the scanner).
- If the barcode is still not readable, lower the print speed <CS> or adjust the print darkness <#E>.
- When using codes like the CODABAR(NW-7), CODE39 include a start / stop character because otherwise the print is executed, but the scanner will not be able to read the data.

CODABAR(NW-7) code table

				S				I				S				O							
				b8	0	0	0	0	0	0	0	0	0	0	0	1	1	1	1	1	1	1	1
				b7	0	0	0	0	1	1	1	1	1	0	0	0	0	0	1	1	1	1	1
				b6	0	0	1	1	0	0	1	1	1	0	0	1	1	0	0	1	0	1	1
				b5	0	1	0	1	0	1	0	1	0	1	0	1	0	1	0	1	0	1	1
b4	b3	b2	b1		0	1	2	3	4	5	6	7	8	9	A	B	C	D	E	F			
0	0	0	0	0			SP	0															
0	0	0	1	1				1	A		a												
0	0	1	0	2				2	B		b												
0	0	1	1	3				3	C		c												
0	1	0	0	4			\$	4	D	T	d	t											
0	1	0	1	5				5	E		e												
0	1	1	0	6				6															
0	1	1	1	7				7															
1	0	0	0	8				8															
1	0	0	1	9				9															
1	0	1	0	A			*	:															
1	0	1	1	B			+																
1	1	0	0	C																			
1	1	0	1	D			-																
1	1	1	0	E			.		N		n												
1	1	1	1	F			/																



CODE39 code table

				S				I				S				O				
<b>b8</b>	0	0	0	0	0	0	0	0	0	1	1	1	1	1	1	1	1	1		
<b>b7</b>	0	0	0	0	1	1	1	1	1	0	0	0	0	1	1	1	1			
<b>b6</b>	0	0	1	1	0	0	1	1	0	0	1	1	0	0	1	1				
<b>b5</b>	0	1	0	1	0	1	0	1	0	1	0	1	0	1	0	1				
<b>b4</b>	<b>b3</b>	<b>b2</b>	<b>b1</b>		<b>0</b>	<b>1</b>	<b>2</b>	<b>3</b>	<b>4</b>	<b>5</b>	<b>6</b>	<b>7</b>	<b>8</b>	<b>9</b>	<b>A</b>	<b>B</b>	<b>C</b>	<b>D</b>	<b>E</b>	<b>F</b>
0	0	0	0	<b>0</b>			SP	0		P										
0	0	0	1	<b>1</b>				1	A	Q										
0	0	1	0	<b>2</b>				2	B	R										
0	0	1	1	<b>3</b>				3	C	S										
0	1	0	0	<b>4</b>			\$	4	D	T										
0	1	0	1	<b>5</b>			%	5	E	U										
0	1	1	0	<b>6</b>				6	F	V										
0	1	1	1	<b>7</b>				7	G	W										
1	0	0	0	<b>8</b>				8	H	X										
1	0	0	1	<b>9</b>				9	I	Y										
1	0	1	0	<b>A</b>			*		J	Z										
1	0	1	1	<b>B</b>			+		K											
1	1	0	0	<b>C</b>					L											
1	1	0	1	<b>D</b>			-		M											
1	1	1	0	<b>E</b>			.		N											
1	1	1	1	<b>F</b>			/		O											

<b>9.7 Barcode</b>			
Available for	CT400/410/420	CT400-2/410-2/420-2	CT408i/412i/424i
<b>GS1-128(UCC/EAN128)</b>		<b>ESC+BI</b>	
<b>&lt;For standard carton ID&gt;</b>			
Hexadecimal code	ESC <1B> <sub>16</sub>	BI <42> <sub>16</sub> <49> <sub>16</sub>	Parameter aabbbcn~n
Initial value	NIL		
Persistence of the command	When printer is powered off	Set parameter will not be retained	
	Validity in a job	Becomes invalid after execution	
	Validity after a job	Becomes invalid after the job	

[Function]

Specifies GS1-128(UCC/EAN128) for standard carton ID.

[Format]

<BI>aabbbcn~n

●Parameter

a	Narrow bar width	=	Valid range :	01 to 12 dots
b	Barcode height	=	Valid range :	001 to 999 dots
c	Font of barcode translation	=	0	: No translation
			1	: Above barcode
			2	: Below barcode
n	Print data	=	Barcode data (17 digits fixed)	

See code table GS1-128(UCC/EAN128).

EAN128 (for standard carton ID)18 digits fixed

- Identifier of a continuous code for freight packaging
- Type of packaging
- Country, manufacturer code
- Serial number for shipping container
- C/D

\* Check digit is automatically added, therefore, specify data in 17 digits excluding check digit.

[Coding Example] Narrow bar width: 03, Barcode height: 150, HR translation: Below, Print data: 12345678901234567

<A>

<V>100<H>200<BI>03150012345678901234567

<Q>2

<Z>

[Notes]

1. This command is used only for UCC128 Common carton ID. EAN128 used for other applications, such as pharmaceutical, horticultural application, use the command <BG> with appropriate application identifier and delimiters.
2. Start character code /Function character/ End character code, and identifier "00" will be automatically added.
3. Check digit Modulus 10 and Modulus 103 will be automatically generated.
4. Sequential numbering by barcode data is possible.
5. Both character pitch of Barcode and HR translation is fixed at 10dots.
6. In case HR translation is longer than the barcode's width, the translation will be left-aligned to the start of barcode.
7. In case HR translation is shorter than the barcode's width, the translation will be center-aligned.
8. HR translation will be printed in OCR-B font.
9. If HR translation is outside the printable area, it will not be printed. Consider the output image when determining the vertical<V> and horizontal<H> print position.

Interleaved2of5  
 Matrix2of5  
 Industrial2of5  
 UPC-A,JAN/EAN8  
 JAN/EAN13,UPC-E  
 GS1-128(UCC/EAN128)  
 MSI Code table

				<b>S</b>				<b>I</b>				<b>S</b>				<b>O</b>				
				<b>b8</b>	0	0	0	0	0	0	0	0	1	1	1	1	1	1	1	1
				<b>b7</b>	0	0	0	0	1	1	1	1	0	0	0	0	1	1	1	1
				<b>b6</b>	0	0	1	1	0	0	1	1	0	0	1	1	0	0	1	1
				<b>b5</b>	0	1	0	1	0	1	0	1	0	1	0	1	0	1	0	1
<b>b4</b>	<b>b3</b>	<b>b2</b>	<b>b1</b>		<b>0</b>	<b>1</b>	<b>2</b>	<b>3</b>	<b>4</b>	<b>5</b>	<b>6</b>	<b>7</b>	<b>8</b>	<b>9</b>	<b>A</b>	<b>B</b>	<b>C</b>	<b>D</b>	<b>E</b>	<b>F</b>
0	0	0	0	<b>0</b>				0												
0	0	0	1	<b>1</b>				1												
0	0	1	0	<b>2</b>				2												
0	0	1	1	<b>3</b>				3												
0	1	0	0	<b>4</b>				4												
0	1	0	1	<b>5</b>				5												
0	1	1	0	<b>6</b>				6												
0	1	1	1	<b>7</b>				7												
1	0	0	0	<b>8</b>				8												
1	0	0	1	<b>9</b>				9												
1	0	1	0	<b>A</b>																
1	0	1	1	<b>B</b>																
1	1	0	0	<b>C</b>																
1	1	0	1	<b>D</b>																
1	1	1	0	<b>E</b>																
1	1	1	1	<b>F</b>																

9.8 Barcode			
Available for			
	CT400/410/420	CT400-2/410-2/420-2	CT408/412/424
<b>CODE93</b>		<b>ESC+BC</b>	
Hexadecimal code	ESC	BC	Parameter
	<1B> <sub>16</sub>	<42> <sub>16</sub> <43> <sub>16</sub>	aabbccn~n
Initial value	NIL		
Persistence of the command	When printer is powered off	Set parameter will not be retained	
	Validity in a job	Becomes invalid after execution	
	Validity after a job	Becomes invalid after the job	

[Function]

Specifies CODE93 Barcode.

[Format]

<BC>aabbccn~n

●Parameter

a	Narrow bar width	=	Valid range : 01 to 12 dots
b	Barcode height	=	Valid range : 001 to 999 dots
c	Data length (digits)	=	Valid range : 01 to 99
n	Print data	=	Barcode data (See CODE93 code table)

[Coding Example] Narrow bar width: 02, Barcode height: 120, Data length: 12, Print data: ABCD123456xy

```
<A>
<V>100<H>200<BC>0212012ABCD123456xy
<Q>2
<Z>
```

[Notes]

1. Check digit is automatically generated and added.
2. The maximum data length is 99 digits.
3. Data length (number of digits) and quantity of actual input data shall be the same.
4. If the input data is not consistent with the specified data length, a command error will occur.

CODE93 Code table

					S				I				S				O									
					b8	0	0	0	0	0	0	0	0	0	1	1	1	1	1	1	1	1	1	1		
					b7	0	0	0	0	1	1	1	1	0	0	0	0	1	1	1	1	1	1	1		
					b6	0	0	1	1	0	0	1	1	0	0	1	1	0	0	1	1	1	1	1	1	
					b5	0	1	0	1	0	1	0	1	0	1	0	1	0	1	0	1	0	1	0	1	1
b4	b3	b2	b1		0	1	2	3	4	5	6	7	8	9	A	B	C	D	E	F						
0	0	0	0	0			SP	0	@	P	`	p														
0	0	0	1	1			!	1	A	Q	a	q														
0	0	1	0	2			"	2	B	R	b	r														
0	0	1	1	3			#	3	C	S	c	s														
0	1	0	0	4			\$	4	D	T	d	t														
0	1	0	1	5			%	5	E	U	e	u														
0	1	1	0	6			&	6	F	V	f	v														
0	1	1	1	7			'	7	G	W	g	w														
1	0	0	0	8			(	8	H	X	h	x														
1	0	0	1	9			)	9	I	Y	i	y														
1	0	1	0	A			*	:	J	Z	j	z														
1	0	1	1	B			+	;	K	[	k	{														
1	1	0	0	C			,	<	L	\	l															
1	1	0	1	D			-	=	M	]	m	}														
1	1	1	0	E			.	>	N	^	n	-														
1	1	1	1	F			/	?	O	_	o	DEL														

Selectable range is 01H thru FFH for Code93.

9.9 Barcode			
Available for			
	CT400/410/420	CT400-2/410-2/420-2	CT408/412/424
<b>CODE128</b>		<b>ESC+BG</b>	
Hexadecimal code	ESC	BG	Parameter
	<1B> <sub>16</sub>	<42> <sub>16</sub> <47> <sub>16</sub>	aabbbn~n
Initial value	NIL		
Persistence of the command	When printer is powered off	Set parameter will not be retained	
	Validity in a job	Becomes invalid after execution	
	Validity after a job	Becomes invalid after the job	

[Function]

Specifies CODE128 barcode.

[Format]

<BG>aabbbn~n

●Parameter

a Narrow bar width = Valid range : 01 to 12 dots  
 b Barcode height = Valid range : 001 to 999 dots  
 n Print data = Barcode data (see code table in next page)

[Coding Example] Narrow bar width: 02, Barcode height: 120, Print data: ABCD123456 (START CODE A)

```
<A>
<V>100<H>200<BG>02120>GABCD123456
<Q>2
<Z>
```

[Notes]

- Add valid start code respectively for Type(A,B,C).
  - START CODE A = [>G]
  - START CODE B = [>H]
  - START CODE C = [>I]
- C/D will be automatically added.
- To use CODE128 START CODE C, length of the print data (number of digits) shall be even.
  - In case data length(number of digits) is only an odd number for START CODE C, you may first select START CODE A or B and add one or digit, then switch to code set character C to make the total data length even. (Example below)
 

Exp1)	15 digits [123456789012345]	:	<B>1<C>23456789012345
Exp2)	9 numeric/6 alphanumeric 123456789ABC123	:	<C>12345678<B>9ABC123
  - If data length is an odd number for START CODE C, "0" will be automatically added to the end of the data.
  - If START CODE is omitted, the data will be printed with START CODE B.

CODE128 Code table

Value	Code A	Code B	Code C
0	SP	SP	00
1	!	!	01
2	"	"	02
3	#	#	03
4	\$	\$	04
5	%	%	05
6	&	&	06
7	'	'	07
8	(	(	08
9	)	)	09
10	*	*	10
11	+	+	11
12	,	,	12
13	-	-	13
14	.	.	14
15	/	/	15
16	0	0	16
17	1	1	17
18	2	2	18
19	3	3	19
20	4	4	20
21	5	5	21
22	6	6	22
23	7	7	23
24	8	8	24
25	9	9	25
26	:	:	26
27	;	;	27
28	<	<	28
29	=	=	29
30	>(NB4)	>(NB4)	30
31	?	?	31
32	@	@	32
33	A	A	33
34	B	B	34
35	C	C	35
36	D	D	36
37	E	E	37
38	F	F	38
39	G	G	39
40	H	H	40
41	I	I	41
42	J	J	42
43	K	K	43
44	L	L	44
45	M	M	45
46	N	N	46
47	O	O	47
48	P	P	48

Value	Code A	Code B	Code C
49	Q	Q	49
50	R	R	50
51	S	S	51
52	T	T	52
53	U	U	53
54	V	V	54
55	W	W	55
56	X	X	56
57	Y	Y	57
58	Z	Z	58
59	[	[	59
60	\	\	60
61	]	]	61
62	^	^	62
63	—	—	63
64	NUL >SP	' >SP	64
65	SOH >!	a >!	65
66	STX >"	b >"	66
67	ETX >#	c >#	67
68	EOT >\$	d >\$	68
69	ENQ >%	e >%	69
70	ACK >&	f >&	70
71	BEL >'	g >'	71
72	BS >(\	h >(\	72
73	HT >)	i >)	73
74	LF >*	j >*	74
75	VT >+	k >+	75
76	FF >.	l >.	76
77	CR >^	m >^	77
78	SO >_	n >_	78
79	SI >`	o >`	79
80	DLE >0	p >0	80
81	DC1 >1	q >1	81
82	DC2 >2	r >2	82
83	DC3 >3	s >3	83
84	DC4 >4	t >4	84
85	NAK >5	u >5	85
86	SYN >6	v >6	86
87	ETB >7	w >7	87
88	CAN >8	x >8	88
89	EM >9	y >9	89
90	SUB >:	z >:	90
91	ESC >;	{ >;	91
92	FS ><	><	92
93	GS >=	} >=	93
94	RS >>	- >>	94
95	US >?	DEL >?	95
96	FNC3 >@	FNC3 >@	96
97	FNC2 >A	FNC2 >A	97



Value	Code A	Code B	Code C
98	SHIFT >B	SHIFT >B	98
99	Code-C >C	Code-C >C	99
100	Code-B >D	FNC4 >D	Code-B >D
101	FNC4 >E	Code-A >E	Code-A >E
102	FNC1 >F	FNC1 >F	FNC1 >F
103	START CODE A >G		
104	B >H		
105	C >I		

**[Important]**

1. If not specifying START CODE, START CODE B will be used for printing.
2. STOP CODE is automatically added by the printer.
3. The higher position addresses than Value64 in Code A and Code B shall be specified as 2 characters including ">".
4. To specify ">", write ">J".

9.10 Barcode			
Available for	CT400/410/420	CT400-2/410-2/420-2	CT408i/412i/424i
<b>UPC add-on barcode (Bookland)</b>		<b>ESC+BF</b>	
Hexadecimal code	ESC <1B> <sub>16</sub>	BF <42> <sub>16</sub> <46> <sub>16</sub>	Parameter aabbbn~n
Initial value	NIL		
Persistence of the command	When printer is powered off	Set parameter will not be retained	
	Validity in a job	Becomes invalid after execution	
	Validity after a job	Becomes invalid after the job	

[Function]

Specifies UPC add-on barcode (Bookland).

[Format]

<BF>aabbbn~n

•Parameter

a      Narrow bar width      = Valid range : 01 to 03 dots  
b      Barcode height          = Valid range : 001 to 999 dots  
n      Print data                 = Barcode data (See Bookland code table)

[Coding Example]

<A>  
<V>725<H>325<BD>3031504902471000739  
<V>760<H>640<BF>**0313021826**  
<Q>2  
<Z>

[Notes]

1. Only numeric can be specified for print data.
2. Valid data length is 2 and 5 digits.
3. Name of the barcode is different in Japan and in overseas market.  
Japan : UPC add-on barcode  
Overseas : Bookland barcode

Bookland Code table

				S				I				S				O					
				b8	0	0	0	0	0	0	0	0	1	1	1	1	1	1	1	1	1
				b7	0	0	0	0	1	1	1	1	0	0	0	0	1	1	1	1	1
				b6	0	0	1	1	0	0	1	1	0	0	1	1	0	0	1	1	1
				b5	0	1	0	1	0	1	0	1	0	1	0	1	0	1	0	1	1
b4	b3	b2	b1		0	1	2	3	4	5	6	7	8	9	A	B	C	D	E	F	
0	0	0	0	0				0													
0	0	0	1	1				1													
0	0	1	0	2				2													
0	0	1	1	3				3													
0	1	0	0	4				4													
0	1	0	1	5				5													
0	1	1	0	6				6													
0	1	1	1	7				7													
1	0	0	0	8				8													
1	0	0	1	9				9													
1	0	1	0	A																	
1	0	1	1	B																	
1	1	0	0	C																	
1	1	0	1	D																	
1	1	1	0	E																	
1	1	1	1	F																	

9.11 Barcode			
Available for	CT400/410/420	CT400-2/410-2/420-2	CT408/412/424i
<b>Postnet barcode</b>		<b>ESC+BP</b>	
Hexadecimal code	ESC <1B> <sub>16</sub>	BP <42> <sub>16</sub> <50> <sub>16</sub>	Parameter n~n
Initial value	None		
Persistence of the command	When printer is powered off	Set parameter will not be retained	
	Validity in a job	Becomes invalid after execution	
	Validity after a job	Becomes invalid after the job	

[Function]

Specifies Postnet barcode.

[Format]

<BP>n~n

●Parameter

n

= Print data (See Postnet Code table in next page)

\* Follow the rule of the maximum data length for each format.

- 5 digits (Postnet-32 format)

- 6 digits (Postnet-37 format)

- 9 digits (Postnet-52 format)

- 11 digits (Postnet-62 Delivery Point format)

[Coding Example] Postal code 11 digits : 01234567890

<A>

<V>100<H>200<BP>01234567890

<Q>2

<Z>

[Notes]

1. Data length other than 5, 6, 9, and 11 digits will be invalid.
2. Only numeric can be specified for print data.

Postnet Code table

					S				I				S				O							
<b>b8</b>					0	0	0	0	0	0	0	0	0	0	1	1	1	1	1	1	1	1	1	1
<b>b7</b>					0	0	0	0	1	1	1	1	0	0	0	0	1	1	1	1	1	1	1	1
<b>b6</b>					0	0	1	1	0	0	1	1	0	0	1	1	0	0	1	1	0	0	1	1
<b>b5</b>					0	1	0	1	0	1	0	1	0	1	0	1	0	1	0	1	0	1	0	1
<b>b4</b>	<b>b3</b>	<b>b2</b>	<b>b1</b>		<b>0</b>	<b>1</b>	<b>2</b>	<b>3</b>	<b>4</b>	<b>5</b>	<b>6</b>	<b>7</b>	<b>8</b>	<b>9</b>	<b>A</b>	<b>B</b>	<b>C</b>	<b>D</b>	<b>E</b>	<b>F</b>				
0	0	0	0	<b>0</b>				0																
0	0	0	1	<b>1</b>				1																
0	0	1	0	<b>2</b>				2																
0	0	1	1	<b>3</b>				3																
0	1	0	0	<b>4</b>				4																
0	1	0	1	<b>5</b>				5																
0	1	1	0	<b>6</b>				6																
0	1	1	1	<b>7</b>				7																
1	0	0	0	<b>8</b>				8																
1	0	0	1	<b>9</b>				9																
1	0	1	0	<b>A</b>																				
1	0	1	1	<b>B</b>																				
1	1	0	0	<b>C</b>																				
1	1	0	1	<b>D</b>																				
1	1	1	0	<b>E</b>																				
1	1	1	1	<b>F</b>																				

9.12 Barcode			
Available for	CT400/416/420	CT400-Z/416-2/420-2	CT408/412/424
<b>Customer barcode</b>		<b>ESC+BZ</b>	
Hexadecimal code	ESC	BZ	Parameter
	<1B> <sub>16</sub>	<42> <sub>16</sub> <5A> <sub>16</sub>	aaaaaaa,n-n
Initial value	None		
Persistence of the command	When printer is powered off	Set parameter will not be retained	
	Validity in a job	Becomes invalid after execution	
	Validity after a job	Becomes invalid after the job	

[Function]

Specifies customer barcode (For Japanese postal service).

[Format]

<BZ>aaaaaaa,n - n

●Parameter

a	Postal code	=	Numeric : 0000000 to 9999999 [7 digits fixed]
n	Print data	=	Data (Address Number) [Max. 13digits] (See code table in next page)

[Coding Example] Postal code: 3310043, Print data: 1-207

```
<A>
<V>100<H>200<BZ>3310043.1-207
<Q>2
<Z>
```

[Notes]

1. Alphanumeric and hyphen (-) can be used in the print data. (See code table in next page.)
2. Alphabet characters in the print data will be counted as 2 digits (Control code+Alphabet). Make sure that the total data length will not exceed the maximum 13 digits.
3. Start/Stop character and Check digit will be automatically added.
4. In case the data length is less than 13digits,control code (CC4) will be automatically added.
5. In case other foreign parameters are specified, or the settings are inconsistent with each other or with data quantity, the barcode may not print correctly or may not be read by a scanner.

Customer barcode (Japanese postal service) code table

					S				I				S				O					
<b>b8</b>					0	0	0	0	0	0	0	0	0	1	1	1	1	1	1	1	1	1
<b>b7</b>					0	0	0	0	1	1	1	1	0	0	0	0	1	1	1	1	1	1
<b>b6</b>					0	0	1	1	0	0	1	1	0	0	1	1	0	0	1	1	1	1
<b>b5</b>					0	1	0	1	0	1	0	1	0	1	0	1	0	1	0	1	0	1
<b>b4</b>	<b>b3</b>	<b>b2</b>	<b>b1</b>		<b>0</b>	<b>1</b>	<b>2</b>	<b>3</b>	<b>4</b>	<b>5</b>	<b>6</b>	<b>7</b>	<b>8</b>	<b>9</b>	<b>A</b>	<b>B</b>	<b>C</b>	<b>D</b>	<b>E</b>	<b>F</b>		
0	0	0	0	<b>0</b>				0		P												
0	0	0	1	<b>1</b>				1	A	Q												
0	0	1	0	<b>2</b>				2	B	R												
0	0	1	1	<b>3</b>				3	C	S												
0	1	0	0	<b>4</b>				4	D	T												
0	1	0	1	<b>5</b>				5	E	U												
0	1	1	0	<b>6</b>				6	F	V												
0	1	1	1	<b>7</b>				7	G	W												
1	0	0	0	<b>8</b>				8	H	X												
1	0	0	1	<b>9</b>				9	I	Y												
1	0	1	0	<b>A</b>					J	Z												
1	0	1	1	<b>B</b>					K													
1	1	0	0	<b>C</b>					L													
1	1	0	1	<b>D</b>			-		M													
1	1	1	0	<b>E</b>					N													
1	1	1	1	<b>F</b>					O													

9.13 Barcode				
Available for				
	CT400/410/420	CT400-2/410-2/420-2		CT408/412/424i
<b>Symbol</b>			<b>ESC+EU</b>	
Hexadecimal code	ESC	EU	Parameter	
	<1B> <sub>16</sub>	<45> <sub>16</sub> <55> <sub>16</sub>	aabb(ccc)n~n	
Initial value	None			

Persistence of the command	When printer is powered off	Set parameter will not be retained
	Validity in a job	Becomes invalid after execution
	Validity after a job	Becomes invalid after the job

[Function]

Specifies EAN.UCC composite symbol.

[Format1]

<EU>aabbn~n

●Parameter

- |   |                   |   |                                                                                                                                                                                                                                           |
|---|-------------------|---|-------------------------------------------------------------------------------------------------------------------------------------------------------------------------------------------------------------------------------------------|
| a | Barcode type      | = | 01: GS1 DATABAR<br>02: GS1 DATABAR Truncated<br>03: GS1 DATABAR Stacked<br>04: GS1 DATABAR Stacked Omnidirectional<br>05: RSS Limited<br>06: GS1 DataBar Expanded Composite(CC-A/CC-B)<br>07: UPC-A<br>08: UPC-E<br>09: EAN13<br>10: EAN8 |
| b | Minimum bar width | = | 01 to 12 dots                                                                                                                                                                                                                             |
| n | Print data        | = | Data (Up to 120 digits for a composite symbol of linear+2D)                                                                                                                                                                               |

Max. number of digit for linear barcode

GS1 DATABAR	13
GS1 DATABAR Truncated	13
GS1 DATABAR Stacked	13
GS1 DATABAR Stacked Omnidirectional	13
RSS Limited	13
UPC-A	11
UPC-E	10 Fixed
Specify linear data based on the form of "XX00000XXX"(X is variable)	
EAN13	12
EAN8	7

\* Check digit will be added automatically

\* To print the composite symbol, delimit the linear code and 2D code by '|'(7CH).

Data = Linear code data | 2D code data

[Format2]

<EU>aabbcccn~n

●Parameter

- |                                                                                                                                          |                     |   |                                                                          |
|------------------------------------------------------------------------------------------------------------------------------------------|---------------------|---|--------------------------------------------------------------------------|
| a                                                                                                                                        | Linear barcode type | = | 11: GS1-128(UCC/EAN128) with CC-A/B<br>12: GS1-128(UCC/EAN128) with CC-C |
| b                                                                                                                                        | Minimum bar width   | = | 01 to 12 dots                                                            |
| c                                                                                                                                        | Barcode height      | = | 001 to 500 dots                                                          |
| * Specify barcode height in direct proportion to bar width.                                                                              |                     |   |                                                                          |
| For example, if the minimum bar width is 03 and Barcode height proportion needs to be 100, the barcode will be printed in 300dot height. |                     |   |                                                                          |
| n                                                                                                                                        | Print data          | = | Data (Up to 120 digits of linear and 2D codes)                           |



Max. number of digit for linear barcode

GS1-128(UCC/EAN128) with CC-A/B	48
GS1-128(UCC/EAN128) with CC-C	48

\* To print the composite symbol, delimit the linear code and 2D code by '|'(7CH).

Data = Linear code data | 2D code data

\* To print the composite symbol with CC-C(PDF417) FNC1(GS), use '#' (23H) as delimiter.

[Notes]

1. Depending on the linear bar code type, parameter setting is different.  
For example barcode height can only be specified for GS1-128(UCC/EAN128) ( EU11, EU12 ).
2. If the print data is not consistent with the format of the linear barcode, composite symbol will not print.
3. Max.number of data digit is 120, however may be constrained by the barcode type and combination of data (numeric/alphabet) etc.
4. Minimum bar width determines the size of the composite symbol.
5. If the produced composite symbol is oversized to the valid printable area, the run-over will be clipped. Please note that there is a risk that the truncated symbol may still be read by a scanner.
6. This command is not supporting RSS Expand.
7. Translation will not be printed by this command.
8. Rotation command <%> can be used in combination with this command, while Expansion <L> can not be used .

9.14 Barcode				
Available for	CT400/410/420		CT400-2/410-2/420-2	
			CT408/412/424i	
UPC-A barcode (Without translation)			ESC+BL	
Hexadecimal code	ESC	BL	Parameter	
	<1B> <sub>16</sub>	<42> <sub>16</sub> <4C> <sub>16</sub>	abbcccn~n	
Initial value	None			
Persistence of the command	When printer is powered off		Set parameter will not be retained	
	Validity in a job		Becomes invalid after execution	
	Validity after a job		Becomes invalid after the job	

[Function]

Specifies UPC-A Barcode with start/end bar in the same length as guide bar.

[Format]

<BL>abbcccn~n

●Parameter

a	Barcode type	= H	:	UPC-A("H"Fixed)
b	Narrow bar width	= Valid range	:	01 to 12 dots
c	Barcode height	= CTSeries	:	001 to 999 dots
n	Print data	= Data	:	11 digits fixed

[Coding Example] Barcode type: UPC-A, Narrow bar width: 03, Barcode height: 120, Print data: 01234567890

```
<A>
<V>100<H>100<BL>H0312001234567890
<Q>2
<Z>
```

[Notes]

1. This command supports UPC-A. Selecting barcode type other than "H" will result in a command error.
2. Refer to the following settings.

Barcode setting		
Guide bar	Translation	Ratio
With	Without	Fixed

3. The command <D> will print the character bars all in the same length. The command <BL> will print the start bar and end bar in the same length as that of guide bars

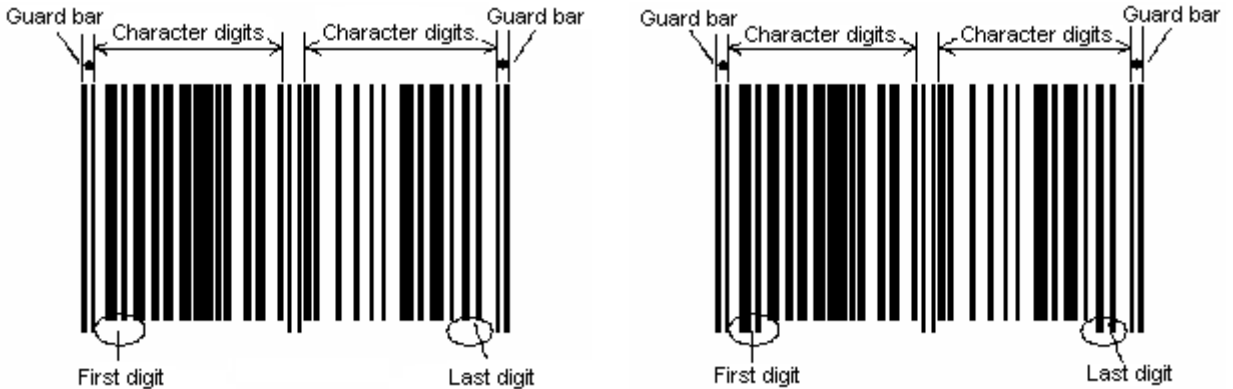

Print result by command <D>

Print result by command <BL>

9.15 Barcode			
Available for	CT400/410/420	CT400-2/410-2/420-2	CT408/412/424i
UPC-A barcode (With translation)		ESC+BL ~ ESC+d	
Hexadecimal code	ESC <1B> <sub>16</sub>	BL~d <42> <sub>16</sub> <4C> <sub>16</sub> -Font type	Parameter Abbccc~n~<d>n~n
Initial value	None		
Persistence of the command	When printer is powered off	Set parameter will not be retained	
	Validity in a job	Becomes invalid after execution	
	Validity after a job	Becomes invalid after the job	

[Function]

Specifies UPC-A barcode with translation

[Format]

<BL>abbccc~n ~ <d>n~n

●Parameter

a	Barcode type	=	H	:	UPC-A ("H" fixed)
b	Narrow bar width	=	Valid range	:	01 to 12 dots
c	Barcode height	=	CTSeries	:	001 to 999 dots
n	Print data	=	Barcode data	:	11 digits fixed
d	Font	=	XU (CT Series only)		
			XS (CT Series only)		
			XM (CT Series only)		
			XB (CT Series only)		
			XL (CT Series only)		
			OA		
			OB		
n	Print data	=	Translation data	:	12 digits fixed

[Coding Example]

Barcode type : UPC-A, Narrow bar width : 02, Barcode height : 120  
Barcode data : 01234567890, Font type : X21, Translation data : 012345678905

```
<A>
<V>100<H>200<BL>H0212001234567890
<X21>012345678905
<Q>2
<Z>
```

[Notes]

1. This command supports UPC-A only. Selecting barcode type other than "H" will be a command error.
2. Recommended narrow bar width for UPC-A with translation :
 

8 dot/mm resolution	[02], [03]
12 dot/mm resolution	[03], [04]
23.6 dot/mm resolution	[06], [07], [08]
3. Correctly calculate the 12<sup>th</sup> check digit of translation by using Modulus 10.
4. Refer to the following settings.

Barcode setting

Guide bar	Translation	Ratio
With	With	Fixed

5. The command <D> with subsequent font type selection will print the character bars all in the same length. The command <BL> with font type selection will print the start bar and end bar in the same length as that of guide bars. Because of the longer start/end bars by the command <BL>, the translation is printed in a smaller character pitches in comparison to that by <D>.



UPC-A print result by the command <D> with subsequent font type selection



UPC-A print result by the command <BL> with subsequent font type selection

9.16 Barcode				
Available for				
	CT400/410/420	CT400-2/410-2/420-2	CT408/412/424i	
UPC-A Barcode (With translation)			ESC+BM	
Hexadecimal code	ESC <1B> <sub>16</sub>	BM <42> <sub>16</sub> <4D> <sub>16</sub>	Parameter abbcccn~n	
Initial value	NIL			
Persistence of the command	When printer is powered off		Set parameter will not be retained	
	Validity in a job		Becomes invalid after execution	
	Validity after a job		Becomes invalid after the job	

[Function]

Specifies UPC-A barcode with translation.

The start and end bar height will be the same length as that of guide bars.

[Format]

<BM>abbcccn~n

●Parameter

a	Barcode type	= H	:	UPC-A ("H" fixed)
b	Narrow bar width	= Valid range	:	01 to 12 dots
c	Barcode height	= CT Series	:	001 to 999 dots
n	Print data	= Data	:	11 digits fixed

[Coding Example] Barcode type : UPC-A, Narrow bar width : 02, Barcode height : 120, Print data : 20123948573

```
<A>
<V>240<H>100<BM>H0212020123948573
<Q>2
<Z>
```

[Notes]

1. This command supports UPC-A only. Selecting barcode type other than "H" will be a command error.
2. Recommended narrow bar width for UPC-A with translation :
  - 8 dots/mm resolution [02], [03]
  - 12 dots/mm resolution [03], [04]
  - 23.6 dot/mm resolution [06], [07], [08]

3. Refer to the following settings.

Barcode setting

Guide bar	Translation	Ratio
With	With	Fixed

4. The command <BD> will print the character bars in the same length. The command <BM> will print the start and end bars in the same length as that of guide bars. Also the command <BD> will print the character bars all in the same length. Because of the longer start/end bars by the command <BM>, the translation is printed in a smaller character pitches in comparison to that by <BD>.

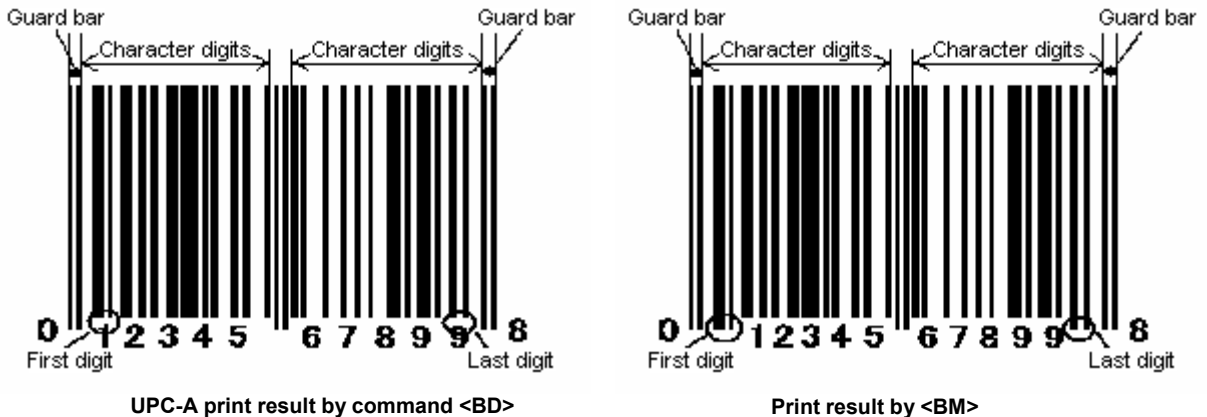

# 10 2D-Code

10.1 2D-Code			
Available for	CT400/416/420	CT400-2/416-2/420-2	CT408/412/424
<b>PDF417</b>		<b>ESC+2D10</b>	
Hexadecimal code	ESC <1B>16	2D10 <32>16<44>16<31>16<30>16	Parameter ,aa,bb,c,dd,ee,(f)
Initial value	NIL		
Persistence of the command	When printer is powered off	Set parameter will not be retained	
	Validity in a job	Becomes invalid after execution	
	Validity after a job	Becomes invalid after the job	

[Function]  
Specifies 2D-Code PDF417.

[Format]  
<2D10>,aa,bb,c,dd,ee,(f)

- Parameter
  - a Minimum module width = Valid range : 01 to 09 dots
  - b Minimum module height = Valid range : 01 to 24 dots
  - c Security level = Valid range : 0 to 8
  - d Code words per line = Valid range : 01 to 30  
00 : Auto (Module width auto-justified according to data quantity)
  - e Rows per symbol = Valid range : 03 to 90  
00 : Auto (Module height auto-justified according to data quantity)
  - f Code type (Omissible) = 0 : Normal  
1 : Truncated

[Format](Data part)  
<DN>mmmm,n~n

- Parameter
  - m Quantity of data = Valid range : 1 to 2681 bytes
  - n Print data = Data

[Coding Example1] Min.module width : 03 dots, Min. module height : 09 dots  
Security level : 3, Data code words per line : 03  
Rows per symbol : 18

```
<A>
<V>100<H>200<2D10>.03.09.3.03.18
<DN>0010,0123456789
<Q>2
<Z>
```



[Coding Example2] Min.module width : 03 dots, Min. module height : 09 dots  
Security Level : 3, Data code words per line : 03  
Rows per symbol : 18, Code type : Truncated

```
<A>
<V>100<H>200<2D10>.03.09.3.03.18.1
<DN>0010,0123456789
<Q>2
<Z>
```



[Notes]

1. By command <V>(Vertical print position) and <H>(Horizontal print position) print start position can be specified.

<V>100<H>200<2D10>\*\*\* . . . . . \*\*

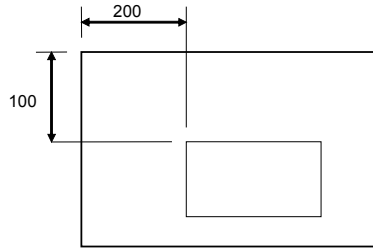

2. In case the both parameter d=e=00, aspect ration will be 1:2.
3. Parameters and data size being inconsistent will not print.
4. Higher Security Level will require larger numbers for "rows per symbol" or "data codeword per line".
5. Min. module width 01,02dot are not recommendable with a risk of lower scanner-readability.
6. Min. module height 01,02,03 dots are not recommendable with a risk of lower scanner-readability.

[Tips]

1. No sequential numbering is possible for PDF417.
2. No print position setting is possible by auto-CR.
3. 00H - FFH can be specified as print data.
4. Increase minimum module dimensions for better quality, as necessary.
5. Increase Security Level for better scanner-readability, as necessary.
6. Height of print image will differ for alphabet, numeric, and alpha-numeric data.

PDF417 Code table

					S				I				S				O					
					b8	0	0	0	0	0	0	0	0	0	1	1	1	1	1	1	1	1
					b7	0	0	0	0	1	1	1	1	0	0	0	0	1	1	1	1	
					b6	0	0	1	1	0	0	1	1	0	0	1	1	0	0	1	1	
					b5	0	1	0	1	0	1	0	1	0	1	0	1	0	1	0	1	
b4	b3	b2	b1		0	1	2	3	4	5	6	7	8	9	A	B	C	D	E	F		
0	0	0	0	0			SP	0	@	P	`	p										
0	0	0	1	1			!	1	A	Q	a	q										
0	0	1	0	2			"	2	B	R	b	r										
0	0	1	1	3			#	3	C	S	c	s										
0	1	0	0	4			\$	4	D	T	d	t										
0	1	0	1	5			%	5	E	U	e	u										
0	1	1	0	6			&	6	F	V	f	v										
0	1	1	1	7			'	7	G	W	g	w										
1	0	0	0	8			(	8	H	X	h	x										
1	0	0	1	9			)	9	I	Y	i	y										
1	0	1	0	A			*	:	J	Z	j	z										
1	0	1	1	B			+	;	K	[	k	{										
1	1	0	0	C			,	<	L	¥	l											
1	1	0	1	D			-	=	M	]	m	}										
1	1	1	0	E			.	>	N	^	n	-										
1	1	1	1	F			/	?	O	_	o	DEL										

Selectable range is 01H thru FFH for PDF Code.



10.2 2D-Code			
Available for			
	CT400/410/420	CT400-2/410-2/420-2	CT408i/412i/424i
<b>Micro PDF417</b>		<b>ESC+2D12</b>	
Hexadecimal code	ESC <1B> <sub>16</sub>	2D12 <32> <sub>16</sub> <44> <sub>16</sub> <31> <sub>16</sub> <32> <sub>16</sub>	Parameter ,aa,bb,c,dd,(e)
Initial value	NIL		

Persistence of the command	When printer is powered off	Set parameter will not be retained
	Validity in a job	Becomes invalid after execution
	Validity after a job	Becomes invalid after the job

[Function]

Specifies Micro PDF417

[Format]

<2D12>,aa,bb,c,dd,(e)

●Parameter

a	Minimum module width	= Valid range : 01 to 09 dots
b	Minimum module height	= Valid range : 01 to 24 dots
c	Code words per line (Cols)	= Valid range : 1 to 4
d	Rows per symbol (Rows)	= Valid range : 2 digits
e	Binary mode (Omissible)	= 0 : Normal (0 When omitted) 1 : Binary mode

[Format] (Data part)

<DN>mmmm,n~n : When Binary mode is set to [1]  
<DS>n~n : When Binary mode is set to [0]

●Parameter

m	Quantity of data	= Valid range : 0001 to 0366 bytes
n	Print data	= Data

[Coding Example] Module width: 02 dots, Module height: 04 dots  
Code words per line: 1, Rows per symbol: 14

<A>  
<V>100<H>200<2D12>02,04,1,14  
<DN>0010,0123456789  
<Q>2  
<Z>



[Note]

1. Rows per symbol is subject to the number of data code word per line. See table in next page for symbol size and data quantity.

Symbol size and Max. data quantity (Byte) of Micro PDF417 (Only the following 34 types are available)

Micro PDF417 Symbol size and data quantity

Symbol size		Max. Data quantity (Byte)		
Cols(c)	Rows(d)	Numeric (A to Z)only	Numeric	Binary
1	11	6	8	3
	14	12	17	7
	17	18	26	10
	20	22	32	13
	24	30	44	18
	28	38	55	22
2	8	14	20	8
	11	24	35	14
	14	36	52	21
	17	46	67	27
	20	56	82	33
	23	64	93	38
	26	72	105	43
3	6	10	14	6
	8	18	26	10
	10	26	38	15
	12	34	49	20
	15	46	67	27
	20	66	96	39
	26	90	132	54
	32	114	167	68
	38	138	202	82
	44	162	237	97
4	4	14	20	8
	6	22	32	13
	8	34	49	20
	10	46	67	27
	12	58	85	34
	15	76	111	45
	20	106	155	63
	26	142	208	85
	32	178	261	106
	38	214	313	128
	44	250	366	150

Alphabet (Upper/Lower case), Numeric, Control code may be mixed for valid combination.

Micro PDF417 Code table

					S				I				S				O					
					b8	0	0	0	0	0	0	0	0	0	1	1	1	1	1	1	1	1
					b7	0	0	0	0	1	1	1	1	0	0	0	0	1	1	1	1	
					b6	0	0	1	1	0	0	1	1	0	0	1	1	0	0	1	1	
					b5	0	1	0	1	0	1	0	1	0	1	0	1	0	1	0	1	
b4	b3	b2	b1		0	1	2	3	4	5	6	7	8	9	A	B	C	D	E	F		
0	0	0	0	0			SP	0	@	P	`	p										
0	0	0	1	1			!	1	A	Q	a	q										
0	0	1	0	2			"	2	B	R	b	r										
0	0	1	1	3			#	3	C	S	c	s										
0	1	0	0	4			\$	4	D	T	d	t										
0	1	0	1	5			%	5	E	U	e	u										
0	1	1	0	6			&	6	F	V	f	v										
0	1	1	1	7			'	7	G	W	g	w										
1	0	0	0	8			(	8	H	X	h	x										
1	0	0	1	9			)	9	I	Y	i	y										
1	0	1	0	A			*	:	J	Z	j	z										
1	0	1	1	B			+	;	K	[	k	{										
1	1	0	0	C			,	<	L	¥	l											
1	1	0	1	D			-	=	M	]	m	}										
1	1	1	0	E			.	>	N	^	n	-										
1	1	1	1	F			/	?	O	_	o	DEL										

Selectable range is 00H thru FFH for Micro PDF Code.

10.3 2D-Code			
Available for	CT400/416/420	CT400-Z/416-2/420-2	CT408/412/424
<b>MAXI code</b>		<b>ESC+2D20</b>	
Hexadecimal code	ESC <1B>16	2D20 <32>16<44>16<32>16<30>16	Parameter ,a(,bbb,ccc,d~d)
Initial value	None		

Persistence of the command	When printer is powered off	Set parameter will not be retained
	Validity in a job	Becomes invalid after execution
	Validity after a job	Becomes invalid after the job

[Function]

Specifies MAXI Code.

[Format](Symbol format setting)

<2D20>,a(,bbb,ccc,d~d)

●Parameter

a	Mode	=	2	:	Delivery (Numeric only)
			3	:	Delivery (Alphanumeric)
			4	:	Standard symbol
			6	:	for Reader device only

The following parameters shall be specified when mode [2] or [3] is selected. Omit the following if selection is [4] and [6].

b	Service class	=	Valid range	:	001 to 999 (Numeric)
c	Country code	=	Valid range	:	001 to 999 (Numeric)
d	Postal code	=	Valid range	:	0 to 999999999 (Mode2) 000000 to 999999 (Mode3)

Mode 2 accepts max. 9digits numeric only  
Mode 3 accepts 6digits only (Upper case only for alphabet)

[Format](Data)

<DN>mmmm,n~n

●Parameter

m	Quantity of data	=	Valid range	:	1 to 138
n	Print data	=	Data		

\* 00H is not a valid selection.

Mode3	Service class	Country code	Postal code	Max. data quantity	
				Numeric	Alphanum.
2	3digits Fixed (Numeric only)	3digits Fixed (Numeric only)	Max. 9 digits	123	84
3			6 digits fixed (Alphanum)		
4	Omitted			138	93
6					

[Coding Example] Mode: Delivery (Numeric only), Service Class: 003, Country code: 081

Postal code: 123456789

```
<A>
<V>100<H>200<2D20>,2,003,081,123456789
<DN>0010,0123456789
<Q>2
<Z>
```

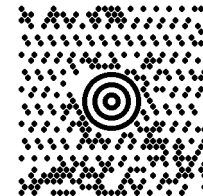

[Notes]

1. The size of the symbol printed is not subject to data volume. (Quantity of data)
2. Any other parameters specified or settings being inconsistent with each other will result in no printing.
3. In case mode [4] or [6] is selected, be sure to have data size (in byte) larger than 12 (bytes), smaller data volume will result in failure of scanner-reading.

**MAXI Code Code table**

					S				I				S				O						
					b8	0	0	0	0	0	0	0	0	1	1	1	1	1	1	1	1	1	
					b7	0	0	0	0	1	1	1	1	0	0	0	0	1	1	1	1	1	
					b6	0	0	1	1	0	0	1	1	0	0	1	1	0	0	1	1	1	
					b5	0	1	0	1	0	1	0	1	0	1	0	1	0	1	0	1	0	1
b4	b3	b2	b1		0	1	2	3	4	5	6	7	8	9	A	B	C	D	E	F			
0	0	0	0	0			SP	0	@	P	`	p											
0	0	0	1	1			!	1	A	Q	a	q											
0	0	1	0	2			"	2	B	R	b	r											
0	0	1	1	3			#	3	C	S	c	s											
0	1	0	0	4			\$	4	D	T	d	t											
0	1	0	1	5			%	5	E	U	e	u											
0	1	1	0	6			&	6	F	V	f	v											
0	1	1	1	7			'	7	G	W	g	w											
1	0	0	0	8			(	8	H	X	h	x											
1	0	0	1	9			)	9	I	Y	i	y											
1	0	1	0	A			*	:	J	Z	j	z											
1	0	1	1	B			+	;	K	[	k	{											
1	1	0	0	C			,	<	L	¥	l												
1	1	0	1	D			-	=	M	]	m	}											
1	1	1	0	E			.	>	N	^	n	-											
1	1	1	1	F			/	?	O	_	o	DEL											

Selectable range is 01H thru FFH for MAXI Code.

10.4 2D-Code			
Available for	CT400/416/420	CT400-Z/410-2/420-2	CT408/412/424
<b>QR code (Model 2)</b>		<b>ESC+2D30</b>	
Hexadecimal code	ESC <1B>16	2D30 <32>16<44>16<33>16<30>16	Parameter ,a,bb,c,d,(ee,ff,gg)
Initial value	None		
Persistence of the command	When printer is powered off	Set parameter will not be retained	
	Validity in a job	Becomes invalid after execution	
	Validity after a job	Becomes invalid after the job	

[Function]

Specifies QR code (Model2)

[Format]

<2D30>,a,bb,c,d,(ee,ff,gg)

●Parameter

- a Error correction level = L : 7%  
M : 15%  
Q : 25%  
H : 30%
- b Size of one side of cell = Valid range : 01 to 32 dots
- c Data setting mode = 0 : Manual  
1 : Auto
- \* Be aware that two different data setting modes above are available.
- d Concatenation mode = 0 : Normal mode  
1 : Concatenation mode

In case concatenation mode is selected, the following settings are mandatory. If normal mode is selected, omit the settings below.

- e Quantity of partitions by concatenation mode = Valid range : 01 to 16  
(How many partitioned QR codes are concatenated.)
- f Sequential number partitioned by concatenation = Valid range : 01 to 16  
(Sequential numbering to each partitioned symbol)
- g Concatenation parity data = Valid range : 00 to FF  
(Parity data is a result of XOR calculation of entire data of QR Code expressed in Hexadecimal character)

[Format](Data part)

<DS>k,n~n  
<DN>mmmm,n~n

●Parameter

- k Input character mode = 1 : Numeric  
2 : Alphanumeric  
3 : Kanji (Shift JIS Kanji code)

This setting is only required when manual data setting is selected.  
Use command <DN> for binary data input.

- m Quantity of data = Valid range : 1 to 2953  
When auto data setting is selected, or binary data input is selected, Quantity of data shall be specified.
- n Print data = Data

[Coding Example] Error correction level: 7%, Size of one side of cell: 05  
Data setting mode: manual, Concatenation mode: Norma<A>

<V>100<H>200<2D30>.L.05.0.0  
<DS>1.012345  
<Q>2  
<Z>



[Notes]

1. In case any other parameters than above are specified, or parameters and quantity of data are not consistent with each other, the symbol will not be printed correctly.
2. Be aware that data part use two different commands <DS> and <DN> according to input mode.

**Auto setting (Data setting mode)**

<DN>mmmm,n~n

[Tips 1]

1. When Kanji is to be specified, quantity of data shall be two times as many as number of total Kanji characters.
2. The address 80H~9FH, E0H~FFH cannot be used for binary data input, since these characters are only handled in Kanji mode.

**Binary input in manual data setting mode**

<DN>mmmm,n~n

**Other input mode**

<DS>1,n - n (Numeric)  
<DS>2,n - n (Alphanumeric)  
<DS>3,n - n (Kanji)

**Mix of different data input mode**

Different data input mode can be used in the same command string. See example below.

<A>  
<V>100<H>100  
<2D30>.a.bb.c.d  
<DS>3,n~n  
<DN>mmmm,n~n  
<DS>1.n~n  
<Q>1  
<Z>

[Tips 2]

1. Data part shall follow directly symbol format part , or a data part and other data part shall follow successively without interval. Otherwise printed result may be incorrect.
2. Quantity of data shall no exceed the maximum 7000 bytes. Also the maximum number of data block, which can be used in one symbol is 200.

QR data size table (Model 2)

Version	Error correction	Numeric	Alphanum	Kanji	Binary
1 21x21	L	41	25	10	17
	M	34	20	8	14
	Q	27	16	7	11
	H	17	10	4	7
2 25x25	L	77	47	20	32
	M	63	38	16	26
	Q	48	29	12	20
	H	34	20	8	14
3 29x29	L	127	77	32	53
	M	101	61	26	42
	Q	77	47	20	32
	H	58	35	15	24
4 33x33	L	187	114	48	78
	M	149	90	38	62
	Q	111	67	28	46
	H	82	50	21	34
5 37x37	L	255	154	65	106
	M	202	122	52	84
	Q	144	87	37	60
	H	106	64	27	44
6 41x41	L	322	195	82	134
	M	255	154	65	106
	Q	178	108	45	74
	H	139	84	36	58
7 45x45	L	370	224	95	154
	M	293	178	75	122
	Q	207	125	53	86
	H	154	93	39	64
8 49x49	L	461	279	118	192
	M	365	221	93	152
	Q	259	157	66	108
	H	202	122	52	84
9 53x53	L	552	335	141	230
	M	432	262	111	180
	Q	312	189	80	130
	H	235	143	60	98
10 57x57	L	652	395	167	271
	M	513	311	131	213
	Q	364	221	93	151
	H	288	174	74	119

Version	Error correction	Numeric	Alphanum	Kanji	Binary
11 61x61	L	772	468	198	321
	M	604	366	155	251
	Q	427	259	109	177
	H	331	200	85	137
12 65x65	L	883	535	226	367
	M	691	419	177	287
	Q	489	296	125	203
	H	374	227	96	155
13 69x69	L	1022	619	262	425
	M	796	483	204	331
	Q	580	352	149	241
	H	427	259	109	177
14 73x73	L	1101	667	282	458
	M	871	528	223	362
	Q	621	376	159	258
	H	468	283	120	194
15 77x77	L	1250	758	320	520
	M	991	600	254	412
	Q	703	426	180	292
	H	530	321	136	220
16 81x81	L	1408	854	361	586
	M	1082	656	277	450
	Q	775	470	198	322
	H	602	365	154	250
17 85x85	L	1548	938	397	644
	M	1212	734	310	504
	Q	876	531	224	364
	H	674	408	173	280
18 89x89	L	1725	1046	442	718
	M	1346	816	345	560
	Q	948	574	243	394
	H	746	452	191	310
19 93x93	L	1903	1153	488	792
	M	1500	909	384	624
	Q	1063	644	272	442
	H	813	493	208	338
20 97x97	L	2061	1249	528	858
	M	1600	970	410	666
	Q	1159	702	297	482
	H	919	557	235	382



Version	Error correction	Numeric	Alphanum	Kanji	Binary
21 101x101	L	2232	1352	572	929
	M	1708	1035	438	711
	Q	1224	742	314	509
	H	969	587	248	403
22 105x105	L	2409	1460	618	1003
	M	1872	1134	480	779
	Q	1358	823	348	565
	H	1056	640	270	439
23 109x109	L	2620	1588	672	1091
	M	2059	1248	528	857
	Q	1468	890	376	611
	H	1108	672	284	461
24 113x113	L	2812	1704	721	1171
	M	2188	1326	561	911
	Q	1588	963	407	661
	H	1228	744	315	511
25 117x117	L	3057	1853	784	1273
	M	2395	1451	614	997
	Q	1718	1041	440	715
	H	1286	779	330	535
26 121x121	L	3283	1990	842	1367
	M	2544	1542	652	1059
	Q	1804	1094	462	751
	H	1425	864	365	593
27 125x125	L	3517	2132	902	1465
	M	2701	1637	692	1125
	Q	1933	1172	496	805
	H	1501	910	385	625
28 129x129	L	3669	2223	940	1528
	M	2857	1732	732	1190
	Q	2085	1263	534	868
	H	1581	958	405	658
29 133x133	L	3909	2369	1002	1628
	M	3035	1839	778	1264
	Q	2181	1322	559	908
	H	1677	1016	430	698
30 137x137	L	4158	2520	1066	1732
	M	3289	1994	843	1370
	Q	2358	1429	604	982
	H	1782	1080	457	742

Version	Error correction	Numeric	Alphanum	Kanji	Binary
31 141x141	L	4417	2677	1132	1840
	M	3486	2113	894	1452
	Q	2473	1499	634	1030
	H	1897	1150	486	790
32 145x145	L	4686	2840	1201	1952
	M	3693	2238	947	1538
	Q	2670	1618	684	1112
	H	2022	1226	518	842
33 149x149	L	4965	3009	1273	2068
	M	3909	2369	1002	1628
	Q	2805	1700	719	1168
	H	2157	1307	553	898
34 153x153	L	5253	3183	1347	2188
	M	4134	2506	1060	1722
	Q	2949	1787	756	1228
	H	2301	1394	590	958
35 157x157	L	5529	3351	1417	2303
	M	4343	2632	1113	1809
	Q	3081	1867	790	1283
	H	2361	1431	605	983
36 161x161	L	5836	3537	1496	2431
	M	4588	2780	1176	1911
	Q	3244	1966	832	1351
	H	2524	1530	647	1051
37 165x165	L	6153	3729	1577	2563
	M	4775	2894	1224	1989
	Q	3417	2071	876	1423
	H	2625	1591	673	1093
38 169x169	L	6479	3927	1661	2699
	M	5039	3054	1292	2099
	Q	3599	2181	923	1499
	H	2735	1658	701	1139
39 173x173	L	6743	4087	1729	2809
	M	5313	3220	1362	2213
	Q	3791	2298	972	1579
	H	2927	1774	750	1219
40 177x177	L	7089	4296	1817	2953
	M	5596	3391	1435	2331
	Q	3993	2420	1024	1663
	H	3057	1852	784	1273

10.5 2D-Code			
Available for	CT400/416/420	CT400-Z/410-2/420-2	CT408/412/424
<b>QR code (Model 1)</b>		<b>ESC+2D31</b>	
Hexadecimal code	ESC <1B> <sub>16</sub>	2D31 <32> <sub>16</sub> <44> <sub>16</sub> <33> <sub>16</sub> <31> <sub>16</sub>	Parameter ,a,bb,c,d,(ee,ff,gg)
Initial value	None		
Persistence of the command	When printer is powered off	Set parameter will not be retained	
	Validity in a job	Becomes invalid after execution	
	Validity after a job	Becomes invalid after the job	

[Function]

Specifies QR code (Model1)

[Format]

<2D31>,a,bb,c,d,(ee,ff,gg)

●Parameter

- a Error correction level = L : 7%  
M : 15%  
Q : 25%  
H : 30%
- b Size of one side of cell = Valid range : 01 to 32 dots
- c Data setting mode = 0 : Manual  
1 : Auto
- Be aware that two different data setting modes above are available.
- d Concatenation mode = 0 : Normal mode  
1 : Concatenation mode

In case concatenation mode is selected, the following settings are mandatory. If normal mode is selected, omit the settings Below.

- e Quantity of partitions by concatenation mode = Valid range : 01 to 16  
(How many partitioned QR codes are concatenated.)
- f Sequential number partitioned by concatenation = Valid range : 01 to 16  
(Sequential numbering to each partitioned symbol)
- g Concatenation parity data = Valid range : 00 to FF  
(Parity data is a result of XOR calculation of entire data of QR Code expressed in Hexadecimal character.)

[Format](Data part)

<DS>k,n~n  
<DN>mmmm,n~n

●Parameter

- k Input character mode = 1 : Numeric  
2 : Alphanumeric  
3 : Kanji (ShiftJIS Kanji code)

This setting is only required when manual data setting is selected.  
Use command <DN> for binary data input.

- m Quantity of data = Valid range : 1 to 486  
When auto data setting is selected, or binary data input is selected, Quantity of data shall be specified.
- n Print data = Data

[Coding Example]      Error correction level: 7%,      Size of one side of cell: 05  
Data setting mode: manual,      Concatenation mode: Normal

<A>  
<V>100<H>200  
<2D31>,L,05,0,0  
<DS>1,012345  
<Q>2  
<Z>



[Notes]

1. In case any other parameters than above are specified, or parameters and quantity of data are not consistent with each other, the symbol will not be printed correctly.
2. Be aware that data part use two different commands <DS> and <DN> according to input mode.

**Auto setting (Data setting mode)**

<DN>mmmm,n~n

[Tips 1]

1. When Kanji is to be specified, quantity of data shall be two times as many as number of total Kanji characters.
2. The address 80H~9FH and E0H~FFH cannot be used for binary data input, since these characters are only handled in Kanji mode.

**Binary input in manual data setting mode**

<DN>mmmm,n~n

**Other input mode**

<DS>1,n~n (Numeric)  
<DS>2,n~n (Alphanumeric)  
<DS>3,n~n (Kanji)

**Mix of different data input mode**

Different data input mode can be used in the same command string. See example below.

<A>  
<V>100<H>100  
<2D31>,a,bb,c,d  
<DS>3,n~n  
<DN>mmmm,n~n  
<DS>1,n~n  
<Q>1  
<Z>

[Tips 2]

1. Data part shall follow directly symbol format part , or a data part and other data part shall follow successively without interval. Otherwise printed result may be incorrect.

QR data size table (Model 1)

Version	Error correction	Numeric	Alphanum	Kanji	Binary	
1	L	40	24	10	17	
	M	33	20	8	14	
	21x21	Q	25	15	6	11
	H	16	10	4	7	
2	L	81	49	20	34	
	M	66	40	17	28	
	25x25	Q	52	31	13	22
	H	33	20	8	14	
3	L	131	79	33	55	
	M	100	60	25	42	
	29x29	Q	81	49	20	34
	H	52	31	13	22	
4	L	186	113	48	78	
	M	138	84	35	58	
	33x33	Q	114	69	29	48
	H	76	46	19	32	
5	L	253	154	65	106	
	M	191	116	49	80	
	37x37	Q	157	95	40	66
	H	105	63	27	44	
6	L	321	194	82	134	
	M	249	151	64	104	
	41x41	Q	201	122	51	84
	H	133	81	34	56	
7	L	402	244	103	168	
	M	311	188	80	130	
	45x45	Q	253	154	65	106
	H	167	101	43	70	
8	L	493	299	126	206	
	M	378	229	97	158	
	49x49	Q	301	183	77	126
	H	203	123	52	85	
9	L	585	354	150	244	
	M	441	267	113	184	
	53x53	Q	369	223	94	154
	H	239	145	61	100	
10	L	690	418	177	287	
	M	526	319	135	219	
	57x57	Q	433	262	111	180
	H	291	176	74	121	

Version	Error correction	Numeric	Alphanum.	Kanji	Binary	
11	L	800	485	205	333	
	M	608	368	156	253	
	61x61	Q	493	299	126	205
	H	342	207	87	142	
12	L	915	555	234	381	
	M	694	421	178	289	
	65x65	Q	579	351	148	241
	H	390	236	100	162	
13	L	1030	624	264	429	
	M	790	479	202	329	
	69x69	Q	656	398	168	273
	H	454	275	116	189	
14	L	1167	707	299	486	
	M	877	531	225	365	
	73x73	Q	738	447	189	307
	H	498	302	127	207	

10.6 2D-Code			
Available for	CT400/416/420	CT400-Z/410-2/420-2	CT408/412/424
<b>Micro QR code</b>		<b>ESC+2D32</b>	
Hexadecimal code	ESC <1B> <sub>16</sub>	2D32 <32> <sub>16</sub> <44> <sub>16</sub> <33> <sub>16</sub> <32> <sub>16</sub>	Parameter ,a,bb,c
Initial value	None		

Persistence of the command	When printer is powered off	Set parameter will not be retained
	Validity in a job	Becomes invalid after execution
	Validity after a job	Becomes invalid after the job

[Function]

Print Micro QR.

[Format] (Symbol Format Setting)

<2D32>,a,bb,c

●Parameter

a	Error correction level	=	L	:	7%
			M	:	15%
			Q	:	25%
b	Size of one side of cell	=	Valid range	:	01 to 32 dots
			0	:	Manual setting
c	Data mode	=	0	:	Manual setting
			1	:	Auto setting

[Format] (Data)

<DS>k,n~n

<DN>mmm,n~n

●Parameter

k	Input mode	=	1	:	Numeric mode
			2	:	Alphanumeric mode
			3	:	Kanji mode (Shift JIS Kanji)

Use command <DN> for binary data input.

m	Quantity of data	=	Valid range	:	1 to 15
This setting is only required for binary data input.					

n	Print data	=	Data
---	------------	---	------

[Coding Example] Error correction level: 7%, Size of one side of cell: 04, Data mode: 1

<A>

<V>100<H>200<2D32>,L,04,1

<DS>1,012345

<Q>2

<Z>



[Notes]

1. In case any other parameters than above are specified, or parameters and quantity of data are not consistent with each other, the symbol will not be printed correctly.
2. Use correct data command <DS> or <DN> according to the different format settings and content of the print data.

**Auto-setting (Data setting mode)**

<DN>mmmm,n~n

## [Tips 1]

1. When Kanji is to be specified, quantity of data shall be two times as many as number of total Kanji characters.
2. The address 80H~9FH and E0H~FFH cannot be used for binary data input, since these characters are only handled in Kanji mode.

**Binary data input**

<DN>mmmm,n~n

**Other data input mode**

<DS>1,n~n (Numeric)

<DS>2,n~n (Alphanumeric)

<DS>3,n~n (Kanji)

**Mix of different data input mode**

Different data input mode can be used in the same command string. See example below.

<A>

<V>100<H>100

<2D32>,a,b

<DS>3,n~n

<DN>mmmm,n~n

<DS>1,n~n

<Q>1

<Z>

## [Tips 2]

1. Data part shall follow directly symbol format part , or a data part and other data part shall follow successively without interval. Otherwise printed result may be incorrect.

Micro QR data size table

Version	Error correction	Numeric	Alphanum.	Kanji	Binary
M1 (11×11)	L (error detection only)	5	—	—	—
M2 (13×13)	L	10	6	—	—
	M	8	5	—	—
M3 (15×15)	L	23	14	6	9
	M	18	11	4	7
M4 (17×17)	L	35	21	9	15
	M	30	18	8	13
	Q	21	13	5	9

QR Code (Numeric mode) table

					S				I				S				O					
<b>b8</b>					0	0	0	0	0	0	0	0	1	1	1	1	1	1	1	1	1	
<b>b7</b>					0	0	0	0	1	1	1	1	0	0	0	0	1	1	1	1	1	
<b>b6</b>					0	0	1	1	0	0	1	1	0	0	1	1	0	0	1	1	1	
<b>b5</b>					0	1	0	1	0	1	0	1	0	1	0	1	0	1	0	1	0	1
<b>b4</b>	<b>b3</b>	<b>b2</b>	<b>b1</b>		<b>0</b>	<b>1</b>	<b>2</b>	<b>3</b>	<b>4</b>	<b>5</b>	<b>6</b>	<b>7</b>	<b>8</b>	<b>9</b>	<b>A</b>	<b>B</b>	<b>C</b>	<b>D</b>	<b>E</b>	<b>F</b>		
0	0	0	0	<b>0</b>				0														
0	0	0	1	<b>1</b>				1														
0	0	1	0	<b>2</b>				2														
0	0	1	1	<b>3</b>				3														
0	1	0	0	<b>4</b>				4														
0	1	0	1	<b>5</b>				5														
0	1	1	0	<b>6</b>				6														
0	1	1	1	<b>7</b>				7														
1	0	0	0	<b>8</b>				8														
1	0	0	1	<b>9</b>				9														
1	0	1	0	<b>A</b>																		
1	0	1	1	<b>B</b>																		
1	1	0	0	<b>C</b>																		
1	1	0	1	<b>D</b>																		
1	1	1	0	<b>E</b>																		
1	1	1	1	<b>F</b>																		

QR Code (Alphanumeric mode) table

					S				I				S				O					
<b>b8</b>					0	0	0	0	0	0	0	0	0	0	1	1	1	1	1	1	1	1
<b>b7</b>					0	0	0	0	1	1	1	1	0	0	0	0	1	1	1	1	1	1
<b>b6</b>					0	0	1	1	0	0	1	1	0	0	1	1	0	0	1	1	1	1
<b>b5</b>					0	1	0	1	0	1	0	1	0	1	0	1	0	1	0	1	0	1
<b>b4</b>	<b>b3</b>	<b>b2</b>	<b>b1</b>		<b>0</b>	<b>1</b>	<b>2</b>	<b>3</b>	<b>4</b>	<b>5</b>	<b>6</b>	<b>7</b>	<b>8</b>	<b>9</b>	<b>A</b>	<b>B</b>	<b>C</b>	<b>D</b>	<b>E</b>	<b>F</b>		
0	0	0	0	<b>0</b>			SP	0		P												
0	0	0	1	<b>1</b>				1	A	Q												
0	0	1	0	<b>2</b>				2	B	R												
0	0	1	1	<b>3</b>				3	C	S												
0	1	0	0	<b>4</b>			\$	4	D	T												
0	1	0	1	<b>5</b>			%	5	E	U												
0	1	1	0	<b>6</b>				6	F	V												
0	1	1	1	<b>7</b>				7	G	W												
1	0	0	0	<b>8</b>				8	H	X												
1	0	0	1	<b>9</b>				9	I	Y												
1	0	1	0	<b>A</b>			*	:	J	Z												
1	0	1	1	<b>B</b>			+		K													
1	1	0	0	<b>C</b>					L													
1	1	0	1	<b>D</b>			-		M													
1	1	1	0	<b>E</b>			.		N													
1	1	1	1	<b>F</b>			/		O													



QR Code (Binary mode) table

					S				I				S				O					
<b>b8</b>					0	0	0	0	0	0	0	0	0	0	1	1	1	1	1	1	1	1
<b>b7</b>					0	0	0	0	1	1	1	1	0	0	0	0	1	1	1	1	1	1
<b>b6</b>					0	0	1	1	0	0	1	1	0	0	1	1	0	0	1	1	1	1
<b>b5</b>					0	1	0	1	0	1	0	1	0	1	0	1	0	1	0	1	0	1
<b>b4</b>	<b>b3</b>	<b>b2</b>	<b>b1</b>		<b>0</b>	<b>1</b>	<b>2</b>	<b>3</b>	<b>4</b>	<b>5</b>	<b>6</b>	<b>7</b>	<b>8</b>	<b>9</b>	<b>A</b>	<b>B</b>	<b>C</b>	<b>D</b>	<b>E</b>	<b>F</b>		
0	0	0	0	<b>0</b>			SP	0	@	P	`	p										
0	0	0	1	<b>1</b>			!	1	A	Q	a	q										
0	0	1	0	<b>2</b>			"	2	B	R	b	r										
0	0	1	1	<b>3</b>			#	3	C	S	c	s										
0	1	0	0	<b>4</b>			\$	4	D	T	d	t										
0	1	0	1	<b>5</b>			%	5	E	U	e	u										
0	1	1	0	<b>6</b>			&	6	F	V	f	v										
0	1	1	1	<b>7</b>			'	7	G	W	g	w										
1	0	0	0	<b>8</b>			(	8	H	X	h	x										
1	0	0	1	<b>9</b>			)	9	I	Y	i	y										
1	0	1	0	<b>A</b>			*	:	J	Z	j	z										
1	0	1	1	<b>B</b>			+	;	K	[	k	{										
1	1	0	0	<b>C</b>			,	<	L	¥	l											
1	1	0	1	<b>D</b>			-	=	M	]	m	}										
1	1	1	0	<b>E</b>			.	>	N	^	n	-										
1	1	1	1	<b>F</b>			/	?	O	_	o	DEL										

The address can be specified in the range [00H~7FH] and [A0H~DFH] for QR Code (Binary mode).

QR Code (Kanji mode) Table

	ShiftJIS	0	1	2	3	4	5	6	7	8	9	A	B	C	D	E	F
Symbol	813F		SP	,	.	,	.	.	:	:	?	!	ˆ	°	´	`	¨
	814F	^	—	—	\	ゞ	ゞ	ゞ	//	全	々	々	○	—	—	-	/
	815F	/	-			...	..	'	'	“	”	(	)	[	]	[	]
	816F	{	}	<	>	《	》	「	」	『	』	【	】	+	-	±	×
	8180	÷	=	≠	<	>	≧	≧	∞	∴	♂	♀	°	'	”	°C	¥
	8190	\$	¢	£	%	#	&	*	@	§	☆	★	◦	●	◎	◇	
	819E		◆	□	■	△	▲	▽	▼	*	〒	→	←	↑	↓	=	
Alphanumeric	824F	0	1	2	3	4	5	6	7	8	9						
	825F		A	B	C	D	E	F	G	H	I	J	K	L	M	N	O
	826F	P	Q	R	S	T	U	V	W	X	Y	Z					
	8280		a	b	c	d	e	f	g	h	i	j	k	l	m	n	o
	8290	p	q	r	s	t	u	v	w	x	y	z					
Hiragana	829E		あ	あ	い	い	う	う	え	え	お	お	か	が	き	ぎ	く
	82AE	ぐ	け	げ	こ	こ	さ	ざ	し	じ	す	ず	せ	が	そ	ぞ	た
	82BE	だ	ち	ぢ	っ	っ	づ	て	で	と	ど	な	に	が	ぬ	ね	は
	82CE	ば	ぱ	ひ	び	び	ふ	ぶ	ぶ	へ	べ	り	に	ほ	ぼ	ぼ	ま
	82DE	む	め	も	ゃ	ゃ	ゆ	ゆ	よ	よ	ら	り	ほ	れ	ろ	わ	わ
	82EE	ゐ	ゑ	を	ん												
Katakana	833F		ア	ア	イ	イ	ウ	ウ	エ	エ	オ	オ	カ	ガ	キ	ギ	ク
	834F	グ	ケ	ゲ	コ	ゴ	サ	ザ	シ	ジ	ス	ズ	セ	ガ	ソ	ゾ	タ
	835F	ダ	チ	ヂ	ツ	ッツ	ツ	テ	デ	ト	ド	ナ	ニ	ガ	ネ	ノ	ハ
	836F	バ	パ	ヒ	ビ	ピ	フ	ブ	プ	ヘ	ベ	リ	ホ	ガ	ポ	マ	ミ
	8380	ム	メ	モ	ヤ	ヤ	ユ	ユ	ヨ	ヨ	ラ	リ	ル	レ	ロ	ワ	ワ
	8390	キ	エ	ヲ	ン	ヴ	カ	ケ									
Greek	839E		A	B	Γ	Δ	E	Z	H	Θ	I	K	Λ	M	N	Ξ	O
	83AE	Π	P	Σ	T	Υ	Φ	X	Ψ	Ω	ι	κ	λ	μ	ν	ξ	ο
	83BE		α	β	Υ	δ	ε	ζ	η	θ	ι	κ	λ	μ	ν	ξ	ο
	83CE	π	ρ	σ	τ	υ	φ	χ	ψ	ω							
Russian	843F		A	B	B	Г	Д	E	E	Ж	З	И	И	К	Л	М	Н
	844F	О	П	Р	С	Т	У	Ф	Х	Ц	Ч	Ш	Щ	Ъ	Ы	Ь	Э
	845F	Ю	Я														
	846F		а	б	в	г	д	е	ё	ж	з	и	й	к	л	м	н
	8480	о	п	р	с	т	у	ф	х	ц	ч	ш	щ	ъ	ы	ь	э
	8490	ю	я														

	ShiftJIS	0	1	2	3	4	5	6	7	8	9	A	B	C	D	E	F
ア	889E 88AE 88BE	垂 旭 粟	葦 葺 裕	啞 芦 安	娃 鯪 庵	阿 梓 按	哀 庄 暗	愛 幹 案	挨 扱 間	始 宛 鞍	逢 姐 杏	葵 虻	茜 飴	穉 絢	惡 綾	握 鮎	渥 或
イ	88BE 88CE 88DE 88EE 893F	夷 萎 稻	委 衣 茨 院	威 謂 芋 陰	尉 違 鱗 隱	惟 遺 允 韻	意 医 印 吋	慰 井 咽	易 亥 員	椅 域 因	為 育 姻	以 畏 郁 引	伊 異 磯 飲	位 移 一 淫	依 維 壹 胤	偉 緯 溢 蔭	困 胃 逸
ウ	893F 894F 895F	碓 雲	臼	渦	嘘	唄	鬱	右 蔚	宇 鰻	烏 姥	羽 廐	迂 浦	雨 瓜	卯 閏	鶉 嚙	窺 云	丑 運
エ	895F 896F 8980 8990	穎 園 艷	荏 英 堰 苑	餌 衛 奄 菌	叡 詠 宴 遠	營 銳 延 鉛	嬰 液 怨 鴛	影 疫 掩 塩	映 益 援	曳 馱 沿	榮 悅 演	永 謁 炎	泳 越 焰	洩 閱 煙	瑛 榎 燕	盈 厭 猿	穎 円 縁
オ	8990 899E 89AE	屋	押 憶	旺 臆	橫 桶	欧 牡	毆 乙	王 俺	於 翁 卸	汚 襖 恩	甥 鶯 温	凹 鷗 穩	央 黃 音	奧 岡	往 沖	忝 荻	億
カ	89AE 89BE 89CE 89DE 89EE 8A3F 8A4F 8A5F 8A6F 8A80 8A90 8A9E 8AAE 8ABE 8ACE 8ADE	伽 火 迦 介 外 垣 覚 檀 叶 完 汗 莞 巖	伽 珂 過 会 魁 咳 柿 角 梶 梶 粥 官 漢 觀 玩	佳 禍 霞 解 晦 害 蚌 赫 赫 鱖 刺 寬 澗 諫 癌	加 禾 蚊 回 械 崖 鈎 較 澗 靴 苺 干 漣 貫 眼	可 稼 俄 塊 海 慨 劃 郭 割 株 瓦 幹 環 還 岩	嘉 箇 峨 壞 灰 概 嚇 閣 喝 兜 乾 患 甘 鑑 翫	夏 花 我 迴 界 涯 各 隔 恰 竈 侃 感 監 間 賈	嫁 苛 牙 快 皆 碍 廓 革 括 蒲 冠 憤 看 閑 雁	家 茄 画 怪 絵 蓋 拈 学 活 釜 寒 憾 竿 関 頑	寡 荷 臥 悔 芥 街 攪 岳 渴 鎌 刊 換 管 陷 顔	科 華 芽 恢 蟹 該 格 榮 滑 嚙 勘 敢 簡 韓 願	暇 菓 蛾 懷 開 鎧 核 額 葛 鴨 勸 柑 緩 館	下 果 蝦 賀 戒 階 骸 殼 顛 裼 栢 卷 桓 缶 館	化 架 課 雅 拐 貝 湮 獲 掛 轄 茅 喚 棺 翰 丸	仮 歌 嘩 餓 改 凱 馨 確 笠 且 萱 堪 款 肝 含	何 河 貨 駕 効 蛙 穫 桴 鯉 姦 歛 艦 岸

	ShiftJIS	0	1	2	3	4	5	6	7	8	9	A	B	C	D	E	F
キ	8ADE												企	伎	危	喜	器
	8AEE	基	奇	嬉	寄	岐	希	幾	忌	揮	机	旗	企	伎	危	喜	器
	8B3F		機	婦	毅	氣	汽	畿	祈	季	稀	紀	既	期	棋	棄	起
	8B4F	軌	輝	歸	騎	鬼	龜	偽	儀	妓	宜	戲	徽	規	記	貴	疑
	8B5F	祇	義	飢	誼	議	掬	菊	鞠	吉	吃	喫	技	擬	欺	犧	杵
	8B6F	黍	却	蟻	脚	虐	逆	丘	久	仇	休	及	桔	橋	詰	砧	救
	8B80	朽	求	汲	泣	灸	球	究	窮	笈	級	糾	給	宮	弓	急	居
	8B90	巨	拒	拋	拳	渠	虛	許	距	鋸	漁	禦	魚	旧	牛	去	居
	8B9E		供	俠	僑	兇	競	共	凶	協	匡	狹	叫	亨	境	興	強
	8BAE	彊	怯	恐	恭	挾	教	橋	況	狂	狹	矯	胸	喬	峽	蕎	鄉
	8BBE	鏡	響	饗	驚	仰	凝	堯	曉	業	局	曲	極	玉	桐	糝	僅
	8BCE	勤	均	巾	錦	斤	欣	銀	琴	禁	禽	筋	緊	芹	菌	矜	襟
8BDE	謹	近	金	吟	銀												
ク	8BDE						九	俱	句	区	狗	玖	矩	苦	軀	驅	駮
	8BEE	駒	具	愚	虞	喰	空	偶	寓	遇	隅	串	櫛	釧	屑	屈	君
	8C3F		掘	窟	沓	靴	轡	窪	熊	限	彖	栗	縹	桑	歛	勳	
	8C4F	薰	訓	群	軍	郡											
ケ	8C4F						卦	袈	祁	係	傾	刑	兄	啓	圭	珪	型
	8C5F	契	形	徑	惠	慶	慧	憩	揭	携	敬	景	桂	溪	畦	稽	系
	8C6F	經	繼	繫	野	荃	荊	蚩	計	詣	警	輕	頸	溪	芸	迎	鯨
	8C80	劇	戟	擊	激	隙	析	傑	欠	詣	潔	穴	結	鷄	訣	月	鯨
	8C90	儉	倦	健	兼	券	劍	喧	圈	決	嫌	建	憲	血	拳	捲	鯨
	8C9E		檢	榘	牽	券	劍	喧	圈	堅	嫌	建	肩	懸	拳	捲	鯨
	8CAE	鍵	險	榘	牽	犬	獻	元	硯	絹	臬	減	見	謙	賢	軒	鯨
	8CBE	言	諺	限	駮	齧	元		敵	幻	弦		源	玄	現	絃	駮
コ	8CBE				乎	個	古	呼	固	姑	孤	己	庫	弧	戸	故	枯
	8CCE	湖	狐	糊	袴	股	胡	菰	虎	誇	跨	鈷	雇	顧	鼓	五	互
	8CDE	伍	午	吳	吾	娛	後	御	悟	梧	檣	瑚	碁	語	誤	護	翻
	8DEE	乞	鯉	交	佞	侯	候	倖	光	公	功	効	碁	厚	口	向	康
	8D3F		后	交	佞	垢	好	孔	孝	宏	工	巧	勾	幸	庾	庚	洪
	8D4F	弘	恒	喉	坑	垢	控	攻	昂	晃	更	杭	巷	梗	江	肯	肱
	8D5F	浩	港	溝	抗	垢	硬	稿	糠	晃	紘	絞	校	梗	江	肯	降
	8D6F	腔	膏	航	甲	皇	衡	講	貢	紅	紘	絞	網	耕	肯	閤	刻
	8D80	項	香	高	鴻	剛	劫	号	合	壕	拷	濠	豪	轟	克	克	刻

	ShiftJIS	0	1	2	3	4	5	6	7	8	9	A	B	C	D	E	F
コ	8D90 8D9E 8DAE	告 紺	国 此 良	穀 頃 魂	酷 今	鵠 困	黒 坤	獄 壘	漉 婚	腰 恨	飭 懇	忽 昏	惚 昆	骨 根	狛 梱	込 混	痕
サ	8DAE 8DBE 8DCE 8DDE 8DEE 8E3F 8E4F 8E5F	娑 歳 材 咋 三 酸	坐 济 罪 榨 察 傘 餐	座 災 財 昨 拶 参 斬	些 挫 采 冚 朔 撮 山 暫	佐 債 犀 坂 柵 擦 惨 残	又 催 碎 阪 窄 札 撒	峻 再 砦 堺 策 殺 散	嵯 最 祭 神 索 薩 棧	左 哉 齋 肴 錯 雜 燦	差 塞 細 咲 桜 阜 珊	查 妻 菜 崎 鮭 鯖 産	沙 宰 裁 埼 笹 捌 算	瑳 彩 載 碕 匙 鏑 纂	砂 才 際 鷺 冊 絞 蚕	詐 採 剂 作 刷 皿 讚	鎖 裁 在 削 晒 贊
シ	8E5F 8E6F 8E80 8E90 8E9E 8EAE 8EBE 8ECE 8EDE 8EEE 8F3F 8F4F 8F5F 8F6F 8F80 8F90 8F9E 8FAE 8FBE 8FCE 8FDE 8FEE 903F	姉 死 諮 式 疾 斜 酌 腫 衆 柔 出 準 署 尚 樟 笑 鉦 情	姿 氏 資 次 識 質 煮 釈 趣 宗 襲 汁 術 潤 書 勝 庄 樵 粧 鍾 擾 拭	子 獅 賜 滋 鳴 実 社 錫 酒 就 讐 洪 述 盾 薯 匠 床 沼 紹 鐘 条 植	屍 祉 雌 治 竺 蔀 紗 若 首 州 蹴 獸 俊 純 諸 升 廠 消 肖 障 杖 殖	市 私 飼 爾 軸 篠 者 寂 儒 修 輯 縱 峻 巡 諸 召 彰 涉 菖 鞞 淨 燭	仕 師 糸 齒 事 瘳 零 柴 車 惹 呪 拾 曾 銃 瞬 醇 叙 商 抄 燒 蕉 丈 暈 織	仔 志 紙 事 痔 霏 柴 車 惹 呪 拾 曾 銃 瞬 醇 叙 商 抄 燒 蕉 丈 暈 織	伺 思 紫 似 磁 七 芝 遮 主 寿 洲 酬 叔 竣 順 女 唱 招 焦 衝 丞 穰 色	使 指 肢 侍 示 叱 屢 蛇 取 授 秀 集 夙 舜 処 序 嘗 掌 照 裳 乘 蒸 触	刺 支 脂 兒 而 執 蕊 邪 守 樹 秋 醜 宿 駿 初 徐 獎 捷 症 訟 冗 讓 食	司 孜 至 字 耳 失 縞 借 手 綬 終 什 淑 准 所 恕 妾 昇 省 証 剩 釀 蝕	史 斯 視 寺 自 嫉 舍 勺 朱 需 繡 住 祝 循 暑 鋤 娼 昌 硝 詔 城 錠 辱	嗣 施 詞 慈 蒔 室 写 尺 殊 囚 習 充 縮 旬 曙 除 宵 昭 礁 詳 場 囑 尻	四 旨 詩 持 辞 悉 射 杓 狩 收 臭 十 肅 楯 渚 傷 將 晶 祥 象 壤 埴 伸	士 枝 試 時 夕 湿 捨 灼 珠 周 舟 從 塾 殉 庶 償 小 松 称 賞 壤 飾 信	始 止 誌 鹿 漆 赦 爵 種 蒐 戎 熟 淳 緒 少 梢 章 醬 常 侵

	ShiftJIS	0	1	2	3	4	5	6	7	8	9	A	B	C	D	E	F
シ	904F	唇	娠	寢	審	心	慎	振	新	晋	森	榛	浸	深	申	疹	真
	905F	神	秦	紳	臣	芯	薪	親	診	身	辛	進	針	震	人	仁	刃
	906F	塵	壬	尋	甚	尽	腎	訊	迅	陣	韌						
ス	906F																
	9080	逗	吹	垂	帥	推	水	炊	睡	粹	翠	筈	誼	須	酢	凶	厨
	9090	瑞	髓	崇	嵩	数	枢	趨	雛	据	杉	袁	遂	醉	錐	錘	随
	909E		澄	摺	寸							相	菅	頗	雀	裾	
セ	909E					世	瀨	畝	是	凄	制	勢	姓	征	性	成	政
	90AE	整	星	晴	棲	栖	正	清	性	生	盛	精	聖	声	製	西	誠
	90BE	誓	請	逝	醒	青	静	齐	税	脆	隻	席	惜	戚	斥	昔	析
	90CE	石	積	籍	績	脊	責	赤	跡	蹟	碩	切	拙	接	撰	折	設
	90DE	窃	節	説	雪	絶	舌	蝉	仙	蹟	千	占	宣	専	尖	川	戰
	90EE	扇	撰	栓	梅	泉	浅	洗	染	先	煎	煽	旋	穿	箭	線	閃
	913F		織	羨	腺	舛	船	薦	詮	潜	踐	選	遷	穿	箭	閃	鮮
914F	前	善	漸	然	全	禅	繕	膳	糶								
ソ	914F																
	915F	狙	疏	疎	礎	祖	租	粗	素	組	噌	塑	咀	措	曾	曾	楚
	916F	双	叢	倉	喪	壯	奏	爽	宋	層	蘇	訴	阻	迦	鼠	僧	創
	9180	操	早	曹	巢	槍	槽	漕	燥	争	匠	惣	想	搜	掃	挿	搔
	9190	草	莊	葬	蒼	藻	装	走	送	遭	瘦	相	窓	糟	総	綜	聰
	919E		臆	蔵	贈	造	促	側	則	即	鎗	霜	騷	像	増	憎	俗
91AE	属	賊	族	統	卒	袖	其	揃	存	息	捉	束	測	足	速		
タ	91AE																
	91BE	太	汰	詫	唾	墮	妥	惰	打	柁	舵	惰	陀	馱	驛	他	多
	91CE	对	耐	岱	帶	待	怠	態	戴	替	泰	滯	胎	腿	苔	体	堆
	91DE	退	速	隊	黛	鯛	代	台	大	第	醒	題	鷹	滝	瀧	袋	貸
	91EE	宅	托	扱	拓	沢	濯	琢	託	鐸	濁	諾	茸	胤	卓	只	啄
	923F		叩	但	達	辰	奪	脱	異	豎	汕	棚	苧	狸	樽	誰	耽
	924F	丹	单	嘆	坦	担	探	旦	歎	淡	湛	炭	谷	端	綻		
925F	胆	蛋	誕	鍛	団	壇	彈	断	暖	檀	段	短	端	綻			
チ	925F																
	926F	弛	恥	智	池	痴	稚	置	致	蚰	遲	馳	築	畜	竹	知	地
	9280	逐	秩	窒	茶	嫡	着	中	仲	宙	忠	抽	昼	柱	注	筑	蓄
	9290	註	酎	鑄	駐	糶	瀦	猪	苧	著	貯	丁	兆	涸	喋	虫	衷

	ShiftJIS	0	1	2	3	4	5	6	7	8	9	A	B	C	D	E	F
チ	929E 92AE 92BE	帖 聽 沈	帳 脹 珍	庀 蝶 賃	帛 調 陳	張 謀 陳	彫 超	徵 跳	懲 鈔	挑 長	暢 頂	朝 鳥	潮 勅	牒 抄	町 直	眺 朕	
ツ	92BE 92CE 92DE	槻 釣	佃 鶴	漬 柘	辻	津 蔦	墜 綴	椎 鏑	槌 椿	迫 潰	鎚 坪	痛 壺	通 孀	塚 紬	柸 爪	捆 吊	
テ	92DE 92EE 933F 934F 935F	悌 徹 点	抵 邸 撤 伝	亭 挺 鄭 轍 殿	低 提 釘 迭 澱	停 梯 鼎 鉄 田	偵 汀 泥 典 電	剃 砒 摘 填	貞 禎 擢 天	呈 程 敵 展	堤 締 滴 店	定 艇 的 添	帝 訂 笛 纏	底 諦 適 甜	庭 蹄 鎬 貼	廷 逋 溺 轉	弟 哲 顛
ト	935F 936F 9380 9390 939E 93AE 93BE 93CE	登 凍 盜 動 得 鳶	菟 刀 淘 董 同 德 苦	賭 唐 湯 蕩 堂 澆 寅	途 塔 濤 藤 導 特 西	都 塘 灯 討 懂 督 瀨	兔 砥 岩 当 豆 洞 篤 屯	吐 砺 島 痘 踏 瞳 毒 惇	堵 努 嶋 禱 逃 童 独 敦	塗 度 悼 等 透 胴 読 沌	妬 土 投 答 錠 苟 析 豚	屠 奴 搭 筒 陶 道 橡 遁	徒 怒 東 糖 頭 銅 凸 頓	斗 倒 桃 統 騰 峠 突 吞	杜 党 禱 到 鬪 鴉 椀 曇	渡 冬 棟 働 匿 届 鈍	
ナ	93DE 93EE	奈 軟	那 難	内 汝	乍	凧 薙	謎 灘			捺 鍋				繩 罨	南		
ニ	93EE 943F		如 尿	二 菲		尼 任	弑 妊 忍	匂 認		賑 肉	虹 廿			日 乳	入		
ヌ	943F									濡							
ネ	943F 944F	念	捻	燃	燃	粘					禰 祢 寧			葱 猫	熱	年	
ノ	944F 945F	農	視	蚤			乃 迺	之		埜 囊	惱 濃			納 能	腦	膿	
ハ	945F 946F 9480 9490 949E 94AE	俳 楳 柏 醜	廢 煤 泊 函 髮	拝 狼 白 箱 伐	巴 排 買 箔 裕 罰	把 敗 売 粕 箸 拔	播 杯 賠 船 肇 箬 筏	霸 盃 陪 薄 箬 櫨 閥	杷 牌 這 迫 櫨 鳩	波 背 蠅 曝 幡 嘶	派 肺 秤 漠 肌 塙	琶 輩 矧 爆 焮 阜 隼	破 配 菽 縛 畠 隼	婆 倍 伯 莫 八 伴	罵 培 剥 駁 鉢 判	芭 媒 博 麥 澆 半	馬 梅 拍 癸 反

	ShiftJIS	0	1	2	3	4	5	6	7	8	9	A	B	C	D	E	F
ハ	94BE 94CE	叛采	帆煩	搬頒	斑飯	板挽	汜晚	汎番	版盤	犯磐	班蕃	畔蛮	繁	般	藩	販	範
ヒ	94CE 94DE 94EE 953F 954F 955F 956F	彼誹	悲費 鼻	扉避 柎	批非 稗紐	披飛 匹	斐樋 疋	比簸 髭	泌備 彦	疲尾 膝	皮微 菱	碑枇 肘	匪秘 毘	卑緋 毚	否罷 眉	妃肥 美筆	庇被 逼豹
フ	956F 9580 9590 959E 95AE	斧武 憤	普舞 福扮	浮葡 腹焚	父蕪 複奮	不符 部覆	付腐 封淵	埠膚 楓弗	夫芙 風弘	婦譜 葦沸	富負 蒞仏	富賦 伏物	布赴 副鮒	府阜 復分	怖附 幅吻	扶侮 服噴	敷撫 墳
ヘ	95AE 95BE 95CE	弊偏	柄變	並片	蔽篇	閉編	陛辺	米返	頁遍	僻便	壁勉	丙癖 婉	併碧 弁	兵別 鞭	塀警	幣蔑	平篋
ホ	95CE 95DE 95EE 963F 964F 965F 966F	圃俸 飽棒 撲	捕包 法鳳 冒朴	步呆 泡鵬 紡乏 牧	甫報 烹乏 肪睦	補奉 砲亡 膨穆	輔寶 縫傍 謀卸	穗峰 胞剖 貌勃	募峯 芳坊 貿没	墓崩 萌妨 鋒殆	慕庖 蓬帽 防堀	戊抱 蜂忘 吠幌	暮捧 褒忙 類奔	母放 訪房 北本	保簿 方豐 暴僕	舖菩 朋邦 望卜	鋪做 鋒某 墨盆
マ	9680 9690 969E	摩鱒	磨榭 漫	魔亦 蔓	麻俣	埋又	妹抹	味末	枚沫	每迄	哩俛	楨繭	幕磨	膜万	枕慢	鮪滿	枉
ミ	969E 96AE	耗	民	眠	味	未	魅	巳	箕	岬	密	蜜	湊	蓑	稔	脈	妙
ム	96AE				務	夢	無	牟	矛	霧	鷓	棕	婿	娘			
メ	96AE 96BE	明	盟	迷	銘	鳴	姪	牝	滅	免	棉	綿	緬	面	冥	名	命
モ	96BE 96CE	茂	妄	孟	毛	猛	盲	網	耗	蒙	儲	木	默	目	空	摸	模餅



	ShiftJIS	0	1	2	3	4	5	6	7	8	9	A	B	C	D	E	F
モ	96DE	尤	戾	粃	貰	問	悶	紋	門	匆							
ヤ	96DE 96EE	矢	厄	役	約	葉	訳	躍	靖	柳	也	冶	夜	爺	耶	野	弥
ユ	96EE 973F 974F		諭	輸	唯	佑	優	勇	友	宥	幽	悠	愉	愈	油	癒	湧
ヨ	974F 975F 976F 9780	誉	輿	預	傭	幼	妖	容	庸	揚	揺	擁	曜	楊	予	余	与
ラ	9780 9790	乱	卵	嵐	欄	濫	羅	螺	裸	来	莱	頼	雷	洛	絡	落	酪
リ	9790 979E 97AE 97BE 97CE	琉	痢	裏	裡	里	離	陸	律	利	吏	履	李	梨	理	璃	溜
ル	97CE 97DE	類												瑠	罌	淚	累
レ	97DE 97EE 983F	齡	令	伶	例	冷	勵	嶺	怜	玲	礼	苓	鈴	隸	零	靈	麗
ロ	983F 984F 985F	樓	榔	浪	漏	呂	魯	櫓	炉	賂	路	露	勞	婁	廊	弄	朗
ワ	985F 986F	椀	倭	和	話	歪	賄	脇	惑	梓	鷺	互	亘	鰐	詫	藁	蕨

	ShiftJIS	0	1	2	3	4	5	6	7	8	9	A	B	C	D	E	F
一	989E		弋	丐	丕												
丨	989E					个	卩										
丶	989E							丶	井								
丿	989E									丿	乂	乖	乘				
乙	989E													亂			
丿	989E 98AE														丿	豫	事
二	98AE		式	于	亞	亟											
一	98AE					一	亢	京		毫	亶						
人	98AE 98BE 98CE 98DE 98EE 993F 994F	仞	伋	仟	价	伉	侏	估	佛	佝	佗	仍	仍	仄	仆	仉	仗
		佩	佰	侑	佯	來	侖	儘	倪	佞	俎	侗	侗	侈	侏	侗	佻
		俾	倚	倨	偃	倪	倥	倅	倅	倅	倡	倩	倅	侑	俚	侗	佻
		偃	假	會	偃	修	偈	倅	倅	倅	偈	倅	倅	倅	倅	倅	倅
			僉	僂	僂	僂	僂	僂	僂	僂	僂	僂	僂	僂	僂	僂	僂
		僂	僂	僂	僂	僂	僂	僂	僂	僂	僂	僂	僂	僂	僂	僂	僂
儿	994F										儿	兀	兒	兌	兔	兢	競
入	995F	兩	兪														
八	995F			兮	冀												
冂	995F					冂	回	册	冉	冂	冂	冂	冕				
冂	995F 996F	寫	冂											冂	冕	冂	冂
丷	996F			丷	决	冂	冲	冰	况	冽	涸	凉	凜				
几	996F 9980													几	處	凵	凭
凵	9980		凵	凵													
刀	9980 9990 999E				刃	刊	刂	刂	刂	刪	刮	刮	剝	剝	剝	剝	剝
		剝	剔	剪	剝	剩	剝	剝	剝	劍	劍	劍	劍	剝	剝	剝	剝
			辦														
力	999E 99AE			勐	劭	劭	劭	劭	劭	勐	勞	勐	勐	飭	勐	勐	勐
勐	99AE																
勐	99AE		勐	勐	勐	勐	勐	勐	勐								
勐	99AE									七							
勐	99AE										匚	匚	匚	匚	匚	匚	匚

	ShiftJIS	0	1	2	3	4	5	6	7	8	9	A	B	C	D	E	F	
匸	99AE																匸 區	
十	99BE	𠂇	卅	卅	卉	卂	準											
卜	99BE								卞									
卩	99BE								卩	卮	𠂇	卻	卷					
厂	99BE 99CE													厂	厖	厠	厦	
厶	99CE				厶	參	篡											
又	99CE							雙	叟	曼	變							
口	99CE 99DE 99EE 9A3F 9A4F 9A5F 9A6F 9A80 9A90	呀 咒 嗽 啣 噤	听 呻 咫 唾 嗔 噤	吭 咀 晒 啣 嘔 噤	吼 嗽 咤 啣 嘔 噤	吮 咄 咄 售 噴 噪	呐 附 高 啜 單 喉 噤	吩 咆 啞 啞 啞 啞 啞	吝 哇 哥 啞 啞 啞 啞	呖 咏 呖 哦 啞 啞 啞	咏 咸 唏 唸 唸 噤 噤	叮 呵 啞 咬 啞 啞 啞 啞	叨 咎 咬 啞 啞 啞 啞 啞	叭 吹 哄 哮 喙 嗅 嚮	叭 呱 哈 哭 喀 嗟 嚮	吁 呷 咨 哺 咯 噤 噤	咩 咩 咩 咩 咩 咩 咩 咩	
口	9A90 9A9E		圈	國	圍	圓	團	圖	喬	口	囧	囧	囧	囧	囧	囧	囧	
土	9A9E 9AAE 9ABE 9ACE 9ADE	坩 埤 墅 壘	垂 聖 壘 壤	垚 垚 墟 壘	坡 埠 埠 壘	坩 坩 壘 壘	垚 垚 壘 壘	垚 垚 壘 壘	垚 垚 壘 壘	坩 垚 壘 壘	坩 垚 壘 壘	坩 垚 壘 壘	坩 垚 壘 壘	坩 垚 壘 壘	坩 垚 壘 壘	坩 垚 壘 壘	坩 垚 壘 壘	坩 垚 壘 壘
士	9ADE				壯	壺	壹	壻	壺	壽								
夕	9ADE									夕								
夕	9ADE										夕	夂						
夕	9ADE													夕	夢	夥		
大	9ADE 9AEE	夭	夂	夸	夾	奇	奕	奂	奎	奚	奘	奢	奠	奧	獎	奘	夫	
女	9B3F 9B4F 9B5F 9B6F	娑 媽 孃	奸 娜 媽 孃	妁 娉 媼 孃	妝 媼 孃	佞 媼 孃	佞 媼 孃	妁 媼 孃	妁 媼 孃	姆 娶 孃	媼 婢 孃	姜 婪 孃	妍 媚 孃	姘 媼 孃	姚 媼 孃	娥 媼 孃	娟 媼 孃	

	ShiftJIS	0	1	2	3	4	5	6	7	8	9	A	B	C	D	E	F
子	9B6F				子	孕	孚	幸	孛	孩	孰	孳	孳	學	孳	孺	
宀	9B6F 9B80 9B90	它 寶	宦 寗	宸 寗	寗	寇	崔	寗	寗	寗	寗	寗	寗	寗	寗	寗	寗
寸	9B90		尅	將	專	對											
小	9B90						尔	尅									
尢	9B90							尢		尢							
尸	9B90 9B9E		屮	屮	屮	屬				尸	尹	屮		屮	屮	屮	
山	9B9E 9BAE 9BBE 9BCE		岬	岬	岬	岬	岬	岬	岬	岬	岬	岬	岬	岬	岬	岬	岬
巛	9BCE																巛
工	9BDE	巫															
巳	9BDE		巳	巳													
巾	9BDE 9BEE				巾	巾	巾	巾	巾	巾	巾	巾	巾	巾	巾	巾	巾
干	9BEE					干	干										
幺	9BEE						幺	麼									
广	9BEE 9C3F		廖	廣	廡	廡	廡	廡		广	庠	廡	廡	廡	廡	廡	廡
廴	9C3F																廴 廴
井	9C4F	井	井	井	井	井											
弋	9C4F						弋	弋									
弓	9C4F							弓		弓	弓	弓	弓	弓	弓	弓	弓
彡	9C5F	彡	彡	彡	彡												
彳	9C5F 9C6F					彳	彳	彳		彳	彳	彳	彳	彳	彳	彳	彳
心	9C6F 9C80 9C90	怵	怵	怵	怵	怵	怵	怵	怵	怵	怵	怵	怵	怵	怵	怵	怵

	ShiftJIS	0	1	2	3	4	5	6	7	8	9	A	B	C	D	E	F
心	9C9E		悄	悛	悻	悵	悵	悵	悵	惡	悻	惠	倦	悴	悴	悽	惆
	9CAE	悵	悵	悵	悵	悵	悵	悵	悵	悵	悵	悵	悵	悵	悵	悵	悵
	9CBE	悵	悵	悵	悵	悵	悵	悵	悵	悵	悵	悵	悵	悵	悵	悵	悵
	9CCE	悵	悵	悵	悵	悵	悵	悵	悵	悵	悵	悵	悵	悵	悵	悵	悵
	9CDE	悵	悵	悵	悵	悵	悵	悵	悵	悵	悵	悵	悵	悵	悵	悵	悵
	9CEE	悵	悵	悵	悵	悵	悵	悵	悵	悵	悵	悵	悵	悵	悵	悵	悵
戈	9CEE									戈	戍	戍	戍	戍	戍	戍	
	9D3F		戍	戍	戍	戍	戍	戍	戍								
戸	9D3F									扁							
手	9D3F										扎	扞	扣	扛	扞	扞	扞
	9D4F	扞	扞	扞	扞	扞	扞	扞	扞	扞	扞	扞	扞	扞	扞	扞	扞
	9D5F	扞	扞	扞	扞	扞	扞	扞	扞	扞	扞	扞	扞	扞	扞	扞	扞
	9D6F	扞	扞	扞	扞	扞	扞	扞	扞	扞	扞	扞	扞	扞	扞	扞	扞
	9D80	扞	扞	扞	扞	扞	扞	扞	扞	扞	扞	扞	扞	扞	扞	扞	扞
	9D90	扞	扞	扞	扞	扞	扞	扞	扞	扞	扞	扞	扞	扞	扞	扞	扞
	9D9E	扞	扞	扞	扞	扞	扞	扞	扞	扞	扞	扞	扞	扞	扞	扞	扞
	9DAE	扞	扞	扞	扞	扞	扞	扞	扞	扞	扞	扞	扞	扞	扞	扞	扞
支	9DAE														支	女	攷
	9DBE	收	攷	攷	攷	攷	攷	攷	攷	攷	攷	攷	攷	攷	攷	攷	攷
斗	9DBE																斛
	9DCE	斛															
斤	9DCE		斫	斫													
方	9DCE				旃	旃	旃	旃	旃	旃	旃	旃					
无	9DCE											无	无	无			
日	9DCE														早	昊	昊
	9DDE	昊	昊	昊	昊	昊	昊	昊	昊	昊	昊	昊	昊	昊	昊	昊	昊
	9DEE	昊	昊	昊	昊	昊	昊	昊	昊	昊	昊	昊	昊	昊	昊	昊	昊
	9E3F	昊	昊	昊	昊	昊	昊	昊	昊	昊	昊	昊	昊	昊	昊	昊	昊
日	9E3F									日	日	日					
月	9E3F													肫	肫	肫	肫
	9E4F	肫	肫														
木	9E4F			朮	朮	朮	朮	朮	朮	杆	杞	杠	杙	杙	杙	杰	
	9E5F	杰	杰	杰	杰	杰	杰	杰	杰	杰	杰	杰	杰	杰	杰	杰	杰
	9E6F	杰	杰	杰	杰	杰	杰	杰	杰	杰	杰	杰	杰	杰	杰	杰	杰

	ShiftJIS	0	1	2	3	4	5	6	7	8	9	A	B	C	D	E	F	
木	9E80	梳	柁	柁	档	桷	梲	梲	梲	梲	梭	梲	條	椰	梲	梲	梲	
	9E90	梳	柁	柁	档	桷	梲	梲	梲	梲	梭	梲	條	椰	梲	梲	梲	
	9E9E	梳	柁	柁	档	桷	梲	梲	梲	梲	梭	梲	條	椰	梲	梲	梲	
	9EAE	梳	柁	柁	档	桷	梲	梲	梲	梲	梭	梲	條	椰	梲	梲	梲	
	9EBE	梳	柁	柁	档	桷	梲	梲	梲	梲	梭	梲	條	椰	梲	梲	梲	
	9ECE	梳	柁	柁	档	桷	梲	梲	梲	梲	梭	梲	條	椰	梲	梲	梲	
	9EDE	梳	柁	柁	档	桷	梲	梲	梲	梲	梭	梲	條	椰	梲	梲	梲	
	9EEE	梳	柁	柁	档	桷	梲	梲	梲	梲	梭	梲	條	椰	梲	梲	梲	
	9F3F	梳	柁	柁	档	桷	梲	梲	梲	梲	梭	梲	條	椰	梲	梲	梲	
	9F4F	梳	柁	柁	档	桷	梲	梲	梲	梲	梭	梲	條	椰	梲	梲	梲	
欠	9F4F								欸	欸	盜	欸	飲	飲	飲	飲	歐	
	9F5F	欸	欸	欸	欸	歡												
止	9F5F					歸												
歹	9F5F						歹	歹		歹	殄	殄	殄	殄	殘	殄	殄	殄
	9F6F	殄	殄	殄	殄	殄												
殳	9F6F					殳	殳	殳		殳								
母	9F6F										母	毓						
毛	9F6F											毳	毳	毳	毳	毳	毳	
	9F80	毳	毳															
氏	9F80			氏														
气	9F80			气	氛	氤	氣											
水	9F80							汞		汕	汙	汪	沂	洵	沁	沛		
	9F90	汾	汨	汨	沒	沐	泄	決	泓	沽	泗	汪	沂	洵	沁	沛		
	9F9E	汾	汨	汨	沒	沐	泄	決	泓	沽	泗	汪	沂	洵	沁	沛		
	9FAE	汾	汨	汨	沒	沐	泄	決	泓	沽	泗	汪	沂	洵	沁	沛		
	9FBE	汾	汨	汨	沒	沐	泄	決	泓	沽	泗	汪	沂	洵	沁	沛		
	9FCE	汾	汨	汨	沒	沐	泄	決	泓	沽	泗	汪	沂	洵	沁	沛		
	9FDE	汾	汨	汨	沒	沐	泄	決	泓	沽	泗	汪	沂	洵	沁	沛		
	9FEE	汾	汨	汨	沒	沐	泄	決	泓	沽	泗	汪	沂	洵	沁	沛		
	E03F	汾	汨	汨	沒	沐	泄	決	泓	沽	泗	汪	沂	洵	沁	沛		
	E04F	汾	汨	汨	沒	沐	泄	決	泓	沽	泗	汪	沂	洵	沁	沛		
E05F	汾	汨	汨	沒	沐	泄	決	泓	沽	泗	汪	沂	洵	沁	沛			
E06F	汾	汨	汨	沒	沐	泄	決	泓	沽	泗	汪	沂	洵	沁	沛			
火	E06F					炙	炒	炯	炯	炬	炸	炳	炳	炮	烟	焦	焦	

	ShiftJIS	0	1	2	3	4	5	6	7	8	9	A	B	C	D	E	F
火	E080 E090 E09E	烙 煩	焉 熨 燹	烽 熬 燿	焜 爛 爍	焙 熹 爐	煥 熾 爛	熙 燒 爨	熙 燉	煦 燂	煢 燎	煌 燠	煖 燬	煬 燧	熏 燧	燻 燼	熄
爪	E09E								爭	爬	爰	爲					
爻	E09E												爻	俎			
爿	E09E E0AE	牋	牘												牘	牘	牘
牛	E0AE			牴	牾	犁	犁	犇	犒	犖	犖	犖					
犬	E0AE E0BE E0CE	狎 猥	狒 猓	貉 獒	狼 獾	狡 默	狹 獬	狷 獮	倏 獨	猗 犖	猊 獸	猜 獵	狷 獻	豺 獾	狃 猴	狃 獾	狄 猓
王	E0CE E0DE E0EE	玻 瑁	珀 瑜	珥 瑩	珮 瑰	珞 瑣	璠 瑪	琅 瑤	瑯 瑾	琥 璋	珣 璞	珵 璧	珷 瓊	瑕 瓏	珈 瓏	玳 瓏	玳 瓏
瓜	E13F		瓠	瓣													
瓦	E13F E14F	甕	甕	甕	甗	甗	瓮	甗	甗	甗	甗	甗	甗	甗	甗	甗	甗
甘	E14F				嘗												
生	E14F					甦											
用	E14F						甬										
田	E14F E15F	畧	畫	畎	畸	當	疆	早	甯	畎	畎	畎	畎	畎	畎	畎	畎
疒	E15F E16F E180 E190 E19E	痂 痂 癩	疖 痒 癩	疝 癩 癩	疝 癩 癩	疽 癩 癩	疽 癩 癩	疼 癩 癩	疱 癩 癩	痂 癩 癩	痊 癩 癩	痒 癩 癩	疔 癩 癩	疥 癩 癩	疥 癩 癩	疥 癩 癩	疥 癩 癩
𠂇	E19E			𠂇	癸	發											
白	E19E						皂	兒	𠂇	皋	皎	皖	皓	皙	皚		
皮	E19E E1AE	鞞	輝	皴												皴	皴
皿	E1AE				孟	盍	盖	盒	盞	盞	盞	盞	盞	盞			
目	E1AE E1BE	眇	眩	昵	眞	眚	眚	昧	眷	眸	睇	睇	睇	睇	眇	眇	眇

	ShiftJIS	0	1	2	3	4	5	6	7	8	9	A	B	C	D	E	F
目	E1CE E1DE	睽 羸	睹 矚	瞎 矚	瞋	瞑	瞠	瞞	瞰	瞶	瞷	瞸	瞹	瞽	瞾	瞿	瞿
矛	E1DE			矜													
矢	E1DE				矣	矮											
石	E1DE E1EE E23F	砗	砗 磳	砗 磳	砗 磳	砗 磳	砗 磳	砗 磳	砗 磳	砗 磳	砗 磳	砗 磳	砗 磳	砗 磳	砗 磳	砗 磳	砗 磳
示	E23F E24F	祕	祕	祕	祕	禊	禊	禊	齋	禪	禮	禳	祀	祠	祗	崇	祚
禺	E24F												禹	禹			
禾	E24F E25F E26F	秬	秬 穉	秬 穉	秬 穉	稍	稭	稭	稭	稭	稭	稭	稭	稭	稭	稭	稭
穴	E26F E280	窶	窶	窶	窶	邃	竇	竇	竇	窵	窵	窵	窵	窵	窵	窵	窵
立	E280 E290	竝	竝	竝					竝	竝	竝	竝	竝	竝	竝	竝	竝
竹	E290 E29E E2AE E2BE E2CE E2DE	筵	筵 筵	筵 筵	筵 筵	筵	筵	筵	筵	筵	筵	筵	筵	筵	筵	筵	筵
米	E2DE E2EE	糝	糝	糝	糝	粿	粿	粿	粿	粿	粿	粿	粿	粿	粿	粿	粿
糸	E2EE E33F E34F E35F E36F E380 E390	絨	絨 絨	絨 絨	絨 絨	絨	絨	絨	絨	絨	絨	絨	絨	絨	絨	絨	絨
缶	E390 E39E	罇	罇	罇	罇	罇	罇							缸	缸		



	ShiftJIS	0	1	2	3	4	5	6	7	8	9	A	B	C	D	E	F
网	E39E E3AE	網	罽	罽	罽	罽	网	罕		罔	罟	罟	罟	罟	罟	罟	罟
羊	E3AE E3BE	羴	羴	羴	羴	羴	羴	羴	羴	羴	羴	羴	羴	羴	羴	羴	羴
羽	E3BE		翊	翊	翊	翊	翊	翊	翊	翊	翊	翊	翊	翊	翊	翊	翊
老	E3BE													耆	耆	耆	耆
耒	E3CE	耒	耒	耒	耒	耒	耒	耒	耒								
耳	E3CE E3DE	聃	聃	聃	聃	聃	聃	聃	聃	聊	聆	聒	聒	聚	聒	聒	聒
聿	E3DE									聿	聿						
肉	E3DE E3EE E43F E44F E45F	胛	胛	胛	胛	胛	胛	胛	胛	胛	胛	胛	胛	胛	胛	胛	胛
臣	E45F									臧							
至	E45F										臺	臻					
臼	E45F E46F	與	舊											臽	舛	舛	舛
舌	E46F		舍	舐		舖											
舟	E46F E480	舳	舳	舳	舳	舳	舳	舳	舳	舳	舳	舳	舳	舳	舳	舳	舳
艮	E480					艱											
艸	E480 E490 E49E E4AE E4BE E4CE E4DE E4EE E53F E54F	苜	苜	苜	苜	苜	苜	苜	苜	艾	芍	芒	芫	芫	芫	芫	芫

	ShiftJIS	0	1	2	3	4	5	6	7	8	9	A	B	C	D	E	F
艸	E55F	蘋	蘋	藺	蘆	龍	蘇	蘘	蘿								
虍	E55F									虍	帀	虔	號	虧			
虫	E55F													虱	蚓	蚣	
	E56F	蚩	蚪	蚋	蚌	蚶	蚯	蛄	蛆	蚰	蛉	螭	蛇	蛔	蛞	蚓	蚣
	E580	蛟	蛛	蛭	蛭	蛭	蜈	蜀	蟹	蛻	蚤	蜂	蜂	蛹	蛭	蛭	蚣
	E590	蟻	蜻	蜥	蜩	蜚	蝠	蝟	蝟	蝟	蝟	蝟	蝟	蝟	蝟	蝟	蝟
	E59E	蟻	蜻	蜥	蜩	蜚	蝠	蝟	蝟	蝟	蝟	蝟	蝟	蝟	蝟	蝟	蝟
	E5AE	螳	蟻	蟻	蟻	蟻	蟻	蟻	蟻	蟻	蟻	蟻	蟻	蟻	蟻	蟻	蟻
	E5BE	蠕	蠹	蠹	蠹	蠹	蠹	蠹	蠹	蠹	蠹	蠹	蠹	蠹	蠹	蠹	蠹
血	E5BE									衄	衄						
行	E5BE											衞	衞	衞	衞		
衣	E5BE															衫	袁
	E5CE	衾	袂	袂	衾	衾	衾	衾	衾	衾	衾	衾	衾	衾	衾	衾	衾
	E5DE	袂	袂	袂	袂	袂	袂	袂	袂	袂	袂	袂	袂	袂	袂	袂	袂
	E5EE	袂	袂	袂	袂	袂	袂	袂	袂	袂	袂	袂	袂	袂	袂	袂	袂
	E63F	襦	襦	襦	襦	襦	襦	襦	襦	襦	襦	襦	襦	襦	襦	襦	襦
而	E63F									而	覃	覈	羈				
見	E63F													覓	覓	覓	覓
	E64F	覓	覓	覓	覓	覺	覽	覓	覓								
角	E64F									觚	觚	觚	觚	觚	觚		
言	E64F															訃	訃
	E65F	訃	訃	訃	訃	訃	訃	訃	訃	訃	訃	訃	訃	訃	訃	訃	訃
	E66F	訃	訃	訃	訃	訃	訃	訃	訃	訃	訃	訃	訃	訃	訃	訃	訃
	E680	訃	訃	訃	訃	訃	訃	訃	訃	訃	訃	訃	訃	訃	訃	訃	訃
	E690	訃	訃	訃	訃	訃	訃	訃	訃	訃	訃	訃	訃	訃	訃	訃	訃
	E69E	訃	訃	訃	訃	訃	訃	訃	訃	訃	訃	訃	訃	訃	訃	訃	訃
谷	E69E															谷	谷
	E6AE	谷															
豆	E6AE		豈	豈	豈	豈											
豕	E6AE					豕	豕	豕	豕								
豸	E6AE									豸	豸	豸	豸	豸	豸	豸	豸
	E6BE	豸	豸	豸													
貝	E6BE				賧	賧	賧	賧	賧	貳	貳	貳	賈	賈	賈	賈	賈
	E6CE	賈	賈	賈	賈	賈	賈	賈	賈	賈	賈	賈	賈	賈	賈	賈	賈

	ShiftJIS	0	1	2	3	4	5	6	7	8	9	A	B	C	D	E	F	
赤	E6CE E6DE	赭															赧	
走	E6DE	走	赴	趁		趙												
足	E6DE E6EE E73F E74F	跟 踏	跣 蹇 躅	跣 蹇 躅	踳 躅	踳 躅	踳 躅	踳 躅	踳 躅	踳 躅	踳 躅	踳 躅	踳 躅	踳 躅	踳 躅	踳 躅	踳 躅	
身	E74F E75F	軀	軀										躬	軀	軀	軀	軀	
車	E75F E76F E780	輟 輟 輟	輟 輟 輟	輟 輟 輟	輟 輟 輟	輟 輟 輟	輟 輟 輟	輟 輟 輟	輟 輟 輟	輟 輟 輟	輟 輟 輟	輟 輟 輟	輟 輟 輟	輟 輟 輟	輟 輟 輟	輟 輟 輟	輟 輟 輟	
辛	E780				辜	辟	辣	辭	辯									
辵	E780 E790 E79E E7AE	迓 迓 迓	迹 迹 迹	迓 迹 迹	迓 迹 迹	迓 迹 迹	迓 迹 迹	迓 迹 迹	迓 迹 迹	迓 迹 迹	迓 迹 迹	迓 迹 迹	迓 迹 迹	迓 迹 迹	迓 迹 迹	迓 迹 迹	迓 迹 迹	
邑	E7AE E7BE	郛	郛	郛	郛				邨	邨	邨	邨	邨	邨	邨	邨	邨	
酉	E7BE E7CE	醫	醢	醢	醢	醢	醢	醢	醢	醢	醢	醢	醢	醢	醢	醢	醢	
采	E7CE									糶	釋							
里	E7CE												釐					
金	E7CE E7DE E7EE E83F E84F E85F E86F	釵 鈔 鎔 鑄 鑄	鈔 鈔 鈔 鈔 鈔	鈔 鈔 鈔 鈔 鈔	鈔 鈔 鈔 鈔 鈔	鈔 鈔 鈔 鈔 鈔	鈔 鈔 鈔 鈔 鈔	鈔 鈔 鈔 鈔 鈔	鈔 鈔 鈔 鈔 鈔	鈔 鈔 鈔 鈔 鈔	鈔 鈔 鈔 鈔 鈔	鈔 鈔 鈔 鈔 鈔	鈔 鈔 鈔 鈔 鈔	鈔 鈔 鈔 鈔 鈔	鈔 鈔 鈔 鈔 鈔	鈔 鈔 鈔 鈔 鈔	鈔 鈔 鈔 鈔 鈔	鈔 鈔 鈔 鈔 鈔
門	E86F E880 E890	閨 關	閨 關	閨 關	閨 關	閨 關	閨 關	閨 關	閨 關	閨 關	閨 關	閨 關	閨 關	閨 關	閨 關	閨 關	閨 關	
阜	E890					阡	阡	阡	阡	阡	阡	阡	阡	阡	阡	阡	阡	

	ShiftJIS	0	1	2	3	4	5	6	7	8	9	A	B	C	D	E	F
阜	E89E		陝	陟	陟	陞	陞	陞	陞	隕	隗	險	隧	隱	隲	隲	隲
隶	E8AE	隶	隸														
佳	E8AE		佳	隹		雋	雉	雍	襍	雜	霍	雕					
雨	E8AE E8BE	雲	霑	霏	霖	雲	雷	霆	霰	霹	霽	霽	霽	霄	霆	霽	霽
青	E8CE	靜															
非	E8CE		靠														
面	E8CE		飽	靦		靨											
革	E8CE E8DE					勒	鞞	鞞	鞞	鞞	鞞	鞞	鞞	鞞	鞞	鞞	鞞
韋	E8DE											韋	韋				
韭	E8DE													韭	齏	壘	
音	E8DE E8EE	韶	韻														竟
頁	E8EE E93F		頰	頰		頰	頰	頰	頰	頰	頰	頰	頰	頰	頰	頰	頰
風	E93F					風	颯	颯	颯	飄	颯	颯					
食	E93F E94F E95F	舖	餘	餡	飭	餞	餞	餅	餽	饗	餽	餽	餽	餽	餽	餽	餽
首	E95F					馮	馮										
香	E95F					馥											
馬	E95F E96F E980	駁	駱	駟	駟	駟	駟	駟	駟	馮	馮	馮	馮	駝	駝	駝	駝
骨	E980 E990	體	體	體	體									骸	骸	骸	骸
高	E990					髒											
髟	E990 E99E		髟	髟	髟	髟	髟	髟	髟	髟	髟	髟	髟	髟	髟	髟	髟
鬥	E99E									鬥	鬥	鬥	鬥	鬥	鬥		
鬯	E99E																鬯
鬼	E9AE	魄	魃	魏	魃	魃	魃	魃									

	ShiftJIS	0	1	2	3	4	5	6	7	8	9	A	B	C	D	E	F	
魚	E9AE E9BE E9CE E9DE	鮠 鮡 鮢 鮣	鮤 鮥 鮦 鮧	鮨 鮪 鮫 鮼	鮺 鮻 鮽 鮾	鮿 鮺 鮻 鮼	鮽 鮾 鮿 鮺	鮻 鮼 鮺 鮻	鮿 鮺 鮻 鮼	鮺 鮻 鮼 鮺	鮻 鮼 鮺 鮻	鮿 鮺 鮻 鮼	鮺 鮻 鮼 鮺	鮻 鮼 鮺 鮻	鮿 鮺 鮻 鮼	鮺 鮻 鮼 鮺	鮻 鮼 鮺 鮻	鮿 鮺 鮻 鮼
鳥	E9DE E9EE EA3F EA4F EA5F	鴉 鴛 鴞 鴟	鴛 鴞 鴟 鴟	鴟 鴟 鴟 鴟	鴟 鴟 鴟 鴟	鴟 鴟 鴟 鴟	鴟 鴟 鴟 鴟	鴟 鴟 鴟 鴟	鴟 鴟 鴟 鴟	鴟 鴟 鴟 鴟	鴟 鴟 鴟 鴟	鴟 鴟 鴟 鴟	鴟 鴟 鴟 鴟	鴟 鴟 鴟 鴟	鴟 鴟 鴟 鴟	鴟 鴟 鴟 鴟	鴟 鴟 鴟 鴟	鴟 鴟 鴟 鴟
鹵	EA5F				鹵	鹹	鹽											
鹿	EA5F						麋	麋	麋	麋	麋	麋	麋	麋	麋	麋	麋	麋
麥	EA5F EA6F																麥	麩
麻	EA6F				靡													
黃	EA6F					覺												
黍	EA6F						黎	黏	糲									
黑	EA6F EA80									黔	黜	黠	黝	黠	黠	黠	黠	黠
帶	EA80				帶	黻	黼											
黽	EA80							黽	鼃	鼃								
鼓	EA80										鼓	鼃						
鼠	EA80												鼠	鼃				
鼻	EA80															鼃		
齊	EA80																齊	
齒	EA80 EA90																	齒
龍	EA90																龍	
龜	EA90																龜	
龠	EA90																龠	

10.7 2D-Code			
Available for	CT400/416/420	CT400-Z/416-2/420-2	CT408/412/424
<b>GS1 Data Matrix (ECC200)</b>		<b>ESC+2D50</b>	
Hexadecimal code	ESC <1B> <sub>16</sub>	2D50 <32> <sub>16</sub> <44> <sub>16</sub> <35> <sub>16</sub> <30> <sub>16</sub>	Parameter ,aa,bb,ccc,ddd
Initial value	None		
Persistence of the command	When printer is powered off	Set parameter will not be retained	
	Validity in a job	Becomes invalid after execution	
	Validity after a job	Becomes invalid after the job	

[Function]

Print Datamatrix code (ECC200).

[Format]Setting

<2D50>,aa,bb,ccc,ddd

•Parameter

a Cell width = Valid range : 01 to 16 dots  
 b Cell height = Valid range : 01 to 16 dots  
 c Number of cell per line = Valid range : 000 (fixed)  
 d Number of line per symbol = Valid range : 000 (fixed)

[Format]Print data

<DN>m m m m,n~n

•Parameter

m Quantity of data = Valid range : 1 to 3116  
 (Only required when data is input in binary.)  
 n Print data = Data  
 To specify 7EH, write [7EH, 7EH].

In case any other parameters than above are specified, or parameters and quantity of data are not consistent with each other, the symbol will not be printed correctly.

[Coding Example] Cell width : 3 dots Cell height : 3 dots

<A>  
 <V>100<H>200<2D50>03,03,000,000  
 <DN>0010,0123456789  
 <Z>



[Notes]

1. In case any other parameters than above are specified, or parameters and quantity of data are not consistent with each other, the symbol will not be printed correctly.
2. Be sure to leave 2mm margin of each side of the symbol for good scanner-readability.
3. To specify the code address [7EH], write [7EH, 7EH]. Quantity of data is [0002].

	Data format	Quantity of data
Data format	Numeric	3116
	Alphanumeric	2335
	Binary (01H to FFH)	1556

**GS1 Data Matrix code table**

				S				I				S				O					
				b8	0	0	0	0	0	0	0	0	0	1	1	1	1	1	1	1	1
				b7	0	0	0	0	1	1	1	1	0	0	0	0	1	1	1	1	
				b6	0	0	1	1	0	0	1	1	0	0	1	1	0	0	1	1	
				b5	0	1	0	1	0	1	0	1	0	1	0	1	0	1	0	1	
b4	b3	b2	b1		0	1	2	3	4	5	6	7	8	9	A	B	C	D	E	F	
0	0	0	0	0			SP	0	@	P	`	p									
0	0	0	1	1			!	1	A	Q	a	q									
0	0	1	0	2			"	2	B	R	b	r									
0	0	1	1	3			#	3	C	S	c	s									
0	1	0	0	4			\$	4	D	T	d	t									
0	1	0	1	5			%	5	E	U	e	u									
0	1	1	0	6			&	6	F	V	f	v									
0	1	1	1	7			'	7	G	W	g	w									
1	0	0	0	8			(	8	H	X	h	x									
1	0	0	1	9			)	9	I	Y	i	y									
1	0	1	0	A			*	:	J	Z	j	z									
1	0	1	1	B			+	;	K	[	k	{									
1	1	0	0	C			,	<	L	¥	l										
1	1	0	1	D			-	=	M	]	m	}									
1	1	1	0	E			.	>	N	^	n	-									
1	1	1	1	F			/	?	O	_	o	DEL									

Address can be selected in the range 01H thru FFH for GS1 Data Matrix.  
 To specify 7EH write [7EH, 7EH].

10.8 2D-Code				
Available for	CT400/410/420		CT400-2/410-2/420-2	
				CT408/412/424
<b>QR code</b>			<b>ESC+BQ</b>	
Hexadecimal code	ESC	BQ	Parameter	
	<1B> <sub>16</sub>	<42> <sub>16</sub> <51> <sub>16</sub>	Manual setting abcc,(ddeeff),g(hhhh)n Auto-setting abcc,(ddeeff),n	
Initial value	None			

Persistence of the command	When printer is powered off	Set parameter will not be retained
	Validity in a job	Becomes invalid after execution
	Validity after a job	Becomes invalid after the job

[Function]

Specifies QR code

[Format]

Manual setting <BQ>abcc,(ddeeff),g(hhhh)n

Auto-setting <BQ>abcc,(ddeeff),n

•Parameter

- a Error correction level = 1 : 7% High density (L)  
2 : 15% Standard (M)  
3 : 30% High reliability (H)  
4 : 25% High reliability (Q)
- b Concatenation mode = 0 : Normal mode  
1 : Concatenation mode
- c Size of one side of cell = Valid range : 01 to 32 dots  
Example) cc=04



- d Quantity of partitions by concatenation mode = Valid range : 01 to 16
- e Sequential number partitioned by concatenation = Valid range : 01 to 16
- f Concatenation mode parity data = Valid range : 00 to FF
- g Input character mode = 1 : Numeric  
2 : Alphanumeric  
3 : Binary  
4 : Kanji
- h Quantity of data = Valid range : 0001 - 7366
- n Print data = Data

[Coding Example] Error correction level: 30%, concatenation mode: standard, size of one side of cell: 10

<A>

<V>100<H>200<BQ>3010,112345

<Q>2

<Z>

[Notes]

1. Parity data is a result of XOR calculation of entire data of QR Code expressed in Hexadecimal character.
2. Quantity of data is not required to specify unless character mode is set to binary.



QR code data size table (for Model1)

Version	Error correction	Numeric	Alpha-Num	Kanji	Binary
1 21x21	L	40	24	10	17
	M	33	20	8	14
	Q	25	15	6	11
	H	16	10	4	7
2 25x25	L	81	49	20	34
	M	66	40	17	28
	Q	52	31	13	22
	H	33	20	8	14
3 29x29	L	131	79	33	55
	M	100	60	25	42
	Q	81	49	20	34
	H	52	31	13	22
4 33x33	L	186	113	48	78
	M	138	84	35	58
	Q	114	69	29	48
	H	76	46	19	32
5 37x37	L	253	154	65	106
	M	191	116	49	80
	Q	157	95	40	66
	H	105	63	27	44
6 41x41	L	321	194	82	134
	M	249	151	64	104
	Q	201	122	51	84
	H	133	81	34	56
7 45x45	L	402	244	103	168
	M	311	188	80	130
	Q	253	154	65	106
	H	167	101	43	70
8 49x49	L	493	299	126	206
	M	378	229	97	158
	Q	301	183	77	126
	H	203	123	52	85
9 53x53	L	585	354	150	244
	M	441	267	113	184
	Q	369	223	94	154
	H	239	145	61	100
10 57x57	L	690	418	177	287
	M	526	319	135	219
	Q	433	262	111	180
	H	291	176	74	121

Version	Error correction	Numeric	Alpha-Num	Kanji	Binary
11 61x61	L	800	485	205	333
	M	608	368	156	253
	Q	493	299	126	205
	H	342	207	87	142
12 65x65	L	915	555	234	381
	M	694	421	178	289
	Q	579	351	148	241
	H	390	236	100	162
13 69x69	L	1030	624	264	429
	M	790	479	202	329
	Q	656	398	168	273
	H	454	275	116	189
14 73x73	L	1167	707	299	486
	M	877	531	225	365
	Q	738	447	189	307
	H	498	302	127	207

QR Code (Numeric mode) table

					S				I				S				O					
<b>b8</b>					0	0	0	0	0	0	0	0	0	1	1	1	1	1	1	1	1	
<b>b7</b>					0	0	0	0	1	1	1	1	0	0	0	0	1	1	1	1	1	
<b>b6</b>					0	0	1	1	0	0	1	1	0	0	1	1	0	0	1	1	1	
<b>b5</b>					0	1	0	1	0	1	0	1	0	1	0	1	0	1	0	1	0	1
<b>b4</b>	<b>b3</b>	<b>b2</b>	<b>b1</b>		<b>0</b>	<b>1</b>	<b>2</b>	<b>3</b>	<b>4</b>	<b>5</b>	<b>6</b>	<b>7</b>	<b>8</b>	<b>9</b>	<b>A</b>	<b>B</b>	<b>C</b>	<b>D</b>	<b>E</b>	<b>F</b>		
0	0	0	0	<b>0</b>				0														
0	0	0	1	<b>1</b>				1														
0	0	1	0	<b>2</b>				2														
0	0	1	1	<b>3</b>				3														
0	1	0	0	<b>4</b>				4														
0	1	0	1	<b>5</b>				5														
0	1	1	0	<b>6</b>				6														
0	1	1	1	<b>7</b>				7														
1	0	0	0	<b>8</b>				8														
1	0	0	1	<b>9</b>				9														
1	0	1	0	<b>A</b>																		
1	0	1	1	<b>B</b>																		
1	1	0	0	<b>C</b>																		
1	1	0	1	<b>D</b>																		
1	1	1	0	<b>E</b>																		
1	1	1	1	<b>F</b>																		

QR Code (alphanumeric) table

				S				I				S				O					
				b8	0	0	0	0	0	0	0	0	1	1	1	1	1	1	1	1	1
				b7	0	0	0	0	1	1	1	1	0	0	0	0	1	1	1	1	1
				b6	0	0	1	1	0	0	1	1	0	0	1	1	0	0	1	1	1
				b5	0	1	0	1	0	1	0	1	0	1	0	1	0	1	0	1	1
b4	b3	b2	b1		0	1	2	3	4	5	6	7	8	9	A	B	C	D	E	F	
0	0	0	0	0			SP	0		P											
0	0	0	1	1				1	A	Q											
0	0	1	0	2				2	B	R											
0	0	1	1	3				3	C	S											
0	1	0	0	4			\$	4	D	T											
0	1	0	1	5			%	5	E	U											
0	1	1	0	6				6	F	V											
0	1	1	1	7				7	G	W											
1	0	0	0	8				8	H	X											
1	0	0	1	9				9	I	Y											
1	0	1	0	A			*	:	J	Z											
1	0	1	1	B			+		K												
1	1	0	0	C					L												
1	1	0	1	D			-		M												
1	1	1	0	E			.		N												
1	1	1	1	F			/		O												

QR Code (Binary mode) table

				S				I				S				O				
				<b>b8</b>	0	0	0	0	0	0	0	0	1	1	1	1	1	1	1	1
				<b>b7</b>	0	0	0	0	1	1	1	1	0	0	0	0	1	1	1	1
				<b>b6</b>	0	0	1	1	0	0	1	1	0	0	1	1	0	0	1	1
				<b>b5</b>	0	1	0	1	0	1	0	1	0	1	0	1	0	1	0	1
<b>b4</b>	<b>b3</b>	<b>b2</b>	<b>b1</b>		<b>0</b>	<b>1</b>	<b>2</b>	<b>3</b>	<b>4</b>	<b>5</b>	<b>6</b>	<b>7</b>	<b>8</b>	<b>9</b>	<b>A</b>	<b>B</b>	<b>C</b>	<b>D</b>	<b>E</b>	<b>F</b>
0	0	0	0	<b>0</b>			SP	0	@	P	`	p								
0	0	0	1	<b>1</b>			!	1	A	Q	a	q								
0	0	1	0	<b>2</b>			"	2	B	R	b	r								
0	0	1	1	<b>3</b>			#	3	C	S	c	s								
0	1	0	0	<b>4</b>			\$	4	D	T	d	t								
0	1	0	1	<b>5</b>			%	5	E	U	e	u								
0	1	1	0	<b>6</b>			&	6	F	V	f	v								
0	1	1	1	<b>7</b>			'	7	G	W	g	w								
1	0	0	0	<b>8</b>			(	8	H	X	h	x								
1	0	0	1	<b>9</b>			)	9	I	Y	i	y								
1	0	1	0	<b>A</b>			*	:	J	Z	j	z								
1	0	1	1	<b>B</b>			+	;	K	[	k	{								
1	1	0	0	<b>C</b>			,	<	L	\	l									
1	1	0	1	<b>D</b>			-	=	M	]	m	}								
1	1	1	0	<b>E</b>			.	>	N	^	n	-								
1	1	1	1	<b>F</b>			/	?	O	_	o	DEL								

The address can be selectable in the range 00H thru 7FH, A0H thru DFH for QR Code (Binary mode).

QR code (Kanji-mode) table

	Shift JIS	0	1	2	3	4	5	6	7	8	9	A	B	C	D	E	F	
Symbol	813F		SP	,	.	,	.	.	:	;	?	!	`	°	'	`	°	
	814F	^	—	—	\	、	、	、	//	全	々	々	〇	—	—	-	/	
	815F	\	-			…	…	'	'	“	”	(	)	[	]	[	]	
	816F	{	}	<	>	《	》	「	」	『	』	【	】	+	-	±	×	
	8180	÷	=	≠	<	>	≦	≧	∞	∴	♂	♀	°	'	”	°C	¥	
	8190	\$	¢	£	%	#	&	*	@	§	☆	★	◦	•	◎	◇		
	819E		◆	□	■	△	▲	▽	▼	*	〒	→	←	↑	↓	=		
Alphanumeric	824F	0	1	2	3	4	5	6	7	8	9			L	M	N	O	
	825F		A	B	C	D	E	F	G	H	I	J	K					
	826F	P	Q	R	S	T	U	V	W	X	Y	Z						
	8280		a	b	c	d	e	f	g	h	i	j	k					
	8290	p	q	r	s	t	u	v	w	x	y	z						
Hiragana	829E		あ	い	う	え	お	か	が	き	ぎ	く						
	82AE	ぐ	け	こ	さ	し	す	せ	げ	そ	ぞ	た						
	82BE	だ	ち	っ	づ	て	ど	な	ぬ	ね	の	は						
	82CE	ば	ぱ	ひ	ふ	ぶ	べ	り	ぼ	ぽ	ま	み						
	82DE	む	め	も	ゆ	よ	ら	る	ろ	わ								
	82EE	ぬ	ゑ	を														
Katakana	833F		ア	イ	ウ	エ	オ	カ	ガ	キ	ギ	ク						
	834F	グ	ケ	コ	サ	シ	ス	セ	ゲ	ソ	ゾ	タ						
	835F	ダ	チ	ッ	ツ	テ	ト	ナ	ネ	ノ	ハ	ミ						
	836F	バ	パ	ヒ	フ	ブ	ヘ	ベ	ポ	マ	ワ							
	8380	ム	メ	モ	ユ	ヨ	ラ	リ	ロ									
	8390	ヰ	ヱ	ヲ	ヴ	カ												
Greek	839E		Α	Β	Γ	Δ	Ε	Ζ	Η	Θ	Ι	Κ	Λ	Μ	Ν	Ξ	Ο	
	83AE	Π	Ρ	Σ	Τ	Υ	Φ	Χ	Ψ	Ω								
	83BE		α	β	γ	δ	ε	ζ	η	θ	ι	κ	λ	μ	ν	ξ	ο	
	83CE	π	ρ	σ	τ	υ	φ	χ	ψ	ω								
Russian	843F		А	Б	В	Г	Д	Е	Ё	Ж	З	И	Й	К	Л	М	Н	
	844F	О	П	Р	С	Т	У	Ф	Х	Ц	Ч	Ш	Щ	Ъ	Ы	Ь	Э	
	845F	Ю	Я															
	846F		а	б	в	г	д	е	ё	ж	з	и	й	к	л	м	н	
	8480	о	п	р	с	т	у	ф	х	ц	ч	ш	щ	ъ	ы	ь	э	
	8490	ю	я															

	Shift JIS	0	1	2	3	4	5	6	7	8	9	A	B	C	D	E	F	
ア	889E 88AE 88BE	垂 旭粟	唾 葦裕	娃 芦安	娃 鯨庵	阿 梓按	哀 压暗	愛 幹案	挨 扱闇	始 宛鞍	逢 姐杏	葵 虻	茜 飴	穉 絢	惡 綾	握 鮎	渥 或	
イ	88BE 88CE 88DE 88EE 893F	夷 萎稻	委 衣茨院	威 謂芋陰	尉 違翽隱	惟 遺允韻	意 医印吋	慰 井咽	易 亥員	椅 域因	為 育姻	以 畏郁引	伊 異磯飲	位 移一淫	依 維壹胤	偉 緯溢蔭	困 胃逸	
ウ	893F 894F 895F	碓 雲	臼	渦	噓	唄	鬱	右 蔚	宇 鰻	烏 姥	羽 廐	迂 浦	雨 瓜	卯 閏	鶉 樽	窺 云	丑 運	
エ	895F 896F 8980 8990	穎 園艷	荏 英堰苑	餌 衛奄菌	叡 詠宴遠	營 銳延鉛	嬰 液怨鴛	影 疫掩塩	映 益援	曳 馱沿	栄 悦演	永 謁炎	泳 越焰	洩 閔煙	瑛 榎燕	盈 厭猿	穎 円縁	
オ	8990 899E 89AE	屋	押 憶	旺 臆	横 桶	欧 牡	毆 乙	王 俺	於 翁卸	汚 襖恩	甥 鶯温	凹 鷓穩	央 黄音	奧 岡	往 冲	忝 荻	億	
カ	89AE 89BE 89CE 89DE 89EE 8A3F 8A4F 8A5F 8A6F 8A80 8A90 8A9E 8AAE 8ABE 8ACE 8ADE	伽 火迦介 外垣 覚檀叶	伽 珂過会 魁咳柿 角梶 杷粥 官漢 覲玩	佳 禍霞解 晦害 峴赫 較渥 靴苻 干漣 貫眼	加 禾蚊回 械崖 鈎較 渥靴 苻干 漣貫 眼	可 稼俄塊 海慨 劃郭 割株 瓦幹 環還 岩	嘉 箇峨壞 灰概 涯各 隔恰 竈侃 乾患 甘鑑 翫	夏 花我迴 界涯 各隔 恰恰 竈侃 乾患 甘鑑 翫	嫁 苛牙快 皆碍 廓革 括蒲 冠慣 看閑 雁	家 茄画怪 絵蓋 拈学 活釜 寒憾 竿閑 頑	寡 荷臥悔 芥街 攪岳 渴滑 鎌刊 換管 陷顏	科 華芽恢 蟹該 格樂 滑滑 嚙勤 敢敢 簡簡 韓願	暇 菓蛾懷 開鎧 核額 葛鴨 勸柑 緩館	下 果蝦賀 戒階 骸骸 顛顛 謁謁 栢栢 卷卷 桓桓 缶館	化 架課 雅雅 拐拐 貝貝 湮湮 獲獲 掛掛 轄轄 茅茅 喚喚 棺棺 翰翰 丸	仮 歌嘩 餓餓 改改 凱凱 馨馨 確確 笠笠 且且 萱萱 堪堪 款款 肝肝 含	何 河貨 駕 効効 蛙蛙 穫穫 檉檉 鯉鯉	姦 歛 艦艦 岸

	ShiftJIS	0	1	2	3	4	5	6	7	8	9	A	B	C	D	E	F	
キ	8ADE													企	伎	危	喜	器
	8AEE	基	奇	嬉	寄	岐	希	幾	忌	揮	机	旗	企	伎	危	喜	器	
	8B3F		機	婦	毅	氣	汽	畿	祈	季	稀	紀	既	規	棋	棄		
	8B4F	軌	輝	飢	騎	鬼	龜	偽	儀	妓	宜	戲	微	擬	記	貴		
	8B5F	祇	義	蟻	誼	議	掬	菊	鞠	吉	吃	喫	技	橋	欺	犧		
	8B6F	祫	却	客	脚	虐	逆	丘	久	仇	休	及	桔	宮	詰	砧		
	8B80	朽	求	汲	泣	灸	球	究	窮	笈	級	糾	吸	旧	弓	急		
	8B90	巨	拒	拋	拳	渠	虛	許	距	笈	漁	禦	給	亨	牛	去		
	8B9E		供	俠	僑	兇	競	共	凶	協	匡	狹	魚	喬	享	京		
	8BAE	彊	怯	恐	恭	挾	教	橋	況	狂	狹	矯	叫	喬	境	峽		
	8BBE	鏡	響	饗	驚	仰	凝	堯	曉	業	局	曲	胸	齋	興	蕎		
	8BCE	勤	均	巾	錦	斤	欣	欽	琴	禁	禽	筋	極	玉	桐	秆		
8BDE	謹	近	金	吟	銀							緊	芹	菌	衿			
ク	8BDE						九	俱	句	区	狗	玖	矩	苦	軀	驅	駮	
	8BEE	駒	具	愚	虞	喰	空	偶	寓	遇	隅	串	櫛	釧	屑	屈	君	
	8C3F		掘	窟	杳	靴	轡	窪	熊	隈	彖	栗	縹	桑	歛	勲		
	8C4F	薰	訓	群	軍	郡												
ケ	8C4F						卦	袈	祁	係	傾	刑	兄	啓	圭	珪	型	
	8C5F	契	形	徑	患	慶	慧	憩	揭	携	敬	景	桂	溪	畦	稽	系	
	8C6F	經	繼	繫	罣	荃	荊	蚩	計	詣	警	輕	頸	鷄	芸	迎	鯨	
	8C80	劇	戟	擊	激	隙	析	傑	欠	詣	潔	穴	頸	血	訣	月	件	
	8C90	儉	倦	健	兼	券	劍	喧	圈	決	嫌	建	結	懸	拳	捲	遣	
	8C9E		檢	權	牽	券	劍	喧	硯	堅	嫌	肩	憲	謙	拳	軒	舷	
	8CAE	鍵	險	顯	驗	犬	獻	元	嚴	絹	臬	減	見	玄	賢	絃		
8CBE	言	諺	限		鯨	元			幻	弦		源		現	絃			
コ	8CBE				乎	個	古	呼	固	姑	孤	己	庫	弧	戸	故	枯	
	8CCE	湖	狐	糊	袴	股	胡	菰	虎	誇	跨	鈷	雇	顧	鼓	五	互	
	8CDE	伍	午	吳	吾	娛	後	御	悟	梧	檣	瑚	碁	語	誤	護	醐	
	8DEE	乞	鯉	交	佼	侯	候	倖	光	公	功	効	碁	厚	口	向	康	
	8D3F		后	喉	坑	垢	好	孔	孝	宏	工	巧	勾	幸	庾	庚	洪	
	8D4F	弘	恒	慌	抗	拘	控	攻	昂	晃	更	杭	巷	梗	構	江	肱	
	8D5F	浩	港	溝	甲	皇	硬	稿	糠	晃	紘	絞	校	梗	考	肯	降	
	8D6F	腔	膏	航	荒	行	衡	講	貢	紅	紘	絞	綱	耕	鋼	閤	刻	
	8D80	項	香	高	鴻	剛	劫	号	合	壕	拷	濠	豪	轟	趨	克		

	ShiftJIS	0	1	2	3	4	5	6	7	8	9	A	B	C	D	E	F
コ	8D90 8D9E 8DAE	告 紺	国 此 良	穀 頃 魂	酷 今	鵠 困	黒 坤	獄 壘	漉 婚	腰 恨	甌 懇	忽 昏	惚 昆	骨 根	狛 梱	込 混	痕
サ	8DAE 8DBE 8DCE 8DDE 8DEE 8E3F 8E4F 8E5F	袞 歳 材 咋 三 酸	坐 濟 罪 搾 察 傘 餐	座 災 財 昨 拶 參 斬	些 挫 采 冚 朔 撮 山 暫	佐 債 犀 坂 柵 擦 慘 殘	又 催 碎 阪 窄 札 撒	峻 再 砦 堺 策 殺 散	嵯 最 祭 榊 索 薩 棧	左 哉 齋 肴 錯 雜 燦	差 塞 細 咲 桜 阜 珊	查 妻 菜 崎 鮭 鯖 産	沙 宰 裁 埼 笹 捌 算	瑳 彩 載 碕 匙 鯖 纂	砂 才 際 鷺 冊 鮫 蚕	詐 採 劑 作 刷 皿 讚	鎖 裁 在 削 晒 贊
シ	8E5F 8E6F 8E80 8E90 8E9E 8EAE 8EBE 8ECE 8EDE 8EEE 8F3F 8F4F 8F5F 8F6F 8F80 8F90 8F9E 8FAE 8FBE 8FCE 8FDE 8FEE 903F	姉 死 諮 式 疾 斜 酌 腫 衆 柔 出 準 署 尚 樟 笑 鉦 情	姿 氏 資 次 識 質 煮 積 趣 宗 襲 汁 術 潤 書 勝 庄 樵 粧 鐘 擾 拭	子 獅 賜 滋 鳴 實 社 錫 酒 就 讐 洪 述 盾 薯 匠 床 沼 紹 鐘 条 植	屍 祉 雌 治 笠 蔀 紗 若 首 州 蹴 獸 俊 純 諸 升 廠 消 肖 障 杖 殖	市 私 飼 爾 軸 篠 者 寂 儒 修 輯 縱 峻 巡 諸 召 彰 涉 菖 鞞 淨 燭	仕 師 糸 齒 事 痔 雫 柴 車 惹 呪 拾 曾 銃 瞬 醇 叙 商 抄 燒 蕉 丈 暈 職	仔 志 紙 事 疇 雫 柴 車 惹 呪 拾 曾 銃 瞬 醇 叙 商 抄 燒 蕉 丈 暈 職	伺 思 紫 似 磁 七 芝 遮 主 寿 洲 酬 叔 竣 順 女 唱 招 焦 衝 丞 穰 色	使 指 肢 侍 示 叱 屢 蛇 取 授 秀 集 夙 舜 処 序 嘗 掌 照 裳 乘 蒸 舐	刺 支 脂 兒 而 執 蕊 邪 守 樹 秋 醜 宿 駿 初 徐 獎 捷 症 訟 冗 讓 食	司 攷 至 字 耳 失 縞 借 手 綬 終 什 淑 准 所 恕 妾 昇 省 証 剩 釀 蝕	史 斯 視 寺 自 嫉 舍 勺 朱 需 繡 住 祝 循 暑 鋤 娼 昌 硝 詔 城 錠 辱	嗣 施 詞 慈 蒔 室 写 尺 殊 囚 習 充 縮 旬 曙 除 宵 昭 礁 詳 場 囑 尻	四 旨 詩 持 辞 悉 射 杓 狩 収 臭 十 肅 楯 渚 傷 將 晶 祥 象 壤 埴 伸	士 枝 試 時 夕 湿 捨 灼 珠 周 舟 從 塾 殉 庶 償 小 松 称 賞 孃 飾 信	始 止 誌 鹿 漆 赦 爵 種 蒐 戎 熟 淳 緒 少 梢 章 醬 常 侵



	ShiftJIS	0	1	2	3	4	5	6	7	8	9	A	B	C	D	E	F
シ	904F	唇	娠	寢	審	心	慎	振	新	晋	森	榛	浸	深	申	疹	真
	905F	神	秦	紳	臣	芯	薪	親	診	身	辛	進	針	震	人	仁	刃
	906F	塵	壬	尋	甚	尽	腎	訊	迅	陣	韌						
ス	906F				帥	推	水	炊	睡			笥	諏	須	酢	凶	厨
	9080	逗	吹	垂	嵩	数	枢	趨	難	粹	翠	衰	遂	醉	錘		隨
	9090	瑞	髓	崇	寸					据	杉	相	菅	頗	雀	裾	
	909E		澄	摺													
セ	909E					世	瀨	畝	是	凄	制	勢	姓	征	性	成	政
	90AE	整	星	晴	棲	栖	正	清	牲	生	盛	精	聖	声	製	西	誠
	90BE	誓	請	逝	醒	青	静	齐	税	脆	隻	席	惜	戚	斥	昔	析
	90CE	石	積	籍	績	脊	責	赤	跡	蹟	碩	切	拙	接	撰	折	設
	90DE	窃	節	説	雪	絶	舌	蝉	仙	先	千	占	宣	専	尖	川	戰
	90EE	扇	撰	栓	梅	泉	浅	洗	染	潜	煎	煽	旋	穿	箭	線	
	913F		織	羨	腺	舛	船	薦	詮	賤	踐	選	遷	穿	箭	閃	鮮
	914F	前	善	漸	然	全	禪	繕	膳	糶				錢	銑		
ソ	914F				礎	祖	租	粗	素	組	噲	塑	岨	措	曾	曾	楚
	915F	狙	疏	疎	喪	壯	奏	爽	宋	層	蘇	訴	阻	迦	鼠	僧	創
	916F	双	叢	倉	巢	壯	槽	漕	燥	争	匠	忽	想	搜	掃	挿	搔
	9180	操	早	曹	蒼	槍	裝	走	送	遭	瘦	相	窓	槽	総	綜	聰
	9190	草	莊	葬	贈	藻	装	側	則	即	鎗	霜	騷	像	増	憎	俗
	919E		臆	藏	族	造	促	其	揃	存	息	捉	束	測	足	速	
	91AE	属	賊	族	統	卒	袖				孫	尊	損	村	遜		
タ	91AE				唾	墮	妥	惰	打	柁	舵	檣	陀	馱	他	多	
	91BE				帶	待	怠	態	戴	替	泰	滯	胎	腿	体	堆	
	91CE	太	汰	詫	黛	待	代	台	大	第	醜	題	鷹	馱	袋	貸	
	91DE	对	耐	隊	拓	鯛	濯	琢	託	鐸	濁	諾	茸	滝	卓	啄	
	91EE	退	速	扨	達	沢	奪	脱	巽	豎	汕	柵	苜	胤	只	誰	
	923F		叩	但	坦	辰	探	旦	歎	淡	湛	炭	谷	狸	樽	耽	
	924F	丹	单	嘆	坦	担	壇	彈	斷	暖	檀	段	短	端	綻		
	925F	胆	蛋	誕	鍛	団							男	端	綻		
チ	925F																
	926F	弛	恥	智	池	痴	稚	置	致	蚰	遲	馳	築	畜	知	地	
	9280	逐	秩	窒	茶	嫡	着	中	仲	宙	忠	抽	昼	柱	筑	蓄	
	9290	註	耐	鑄	駐	禱	瀦	猪	苧	苧	貯	丁	兆	凋	虫	衷	

	ShiftJIS	0	1	2	3	4	5	6	7	8	9	A	B	C	D	E	F
チ	929E 92AE 92BE	帖 聴 沈	帳 脹 珍	庁 蝶 賃	庀 蝶 鎮	弔 調 陳	張 謀	彫 超	微 跳	懲 鈔	挑 長	暢 頂	朝 鳥	潮 勅	牒 抄	町 直	眺 朕
ツ	92BE 92CE 92DE	槻 釣	佃 鶴	漬 柘	柘	辻	津 蔦	墜 綴	椎 鏑	槌 椿	追 潰	鎚 坪	痛 壺	通 孀	塚 紬	柸 爪	掴 吊
テ	92DE 92EE 933F 934F 935F	悌 徹 点	抵 邸 撤 伝	亭 挺 鄭 轍 殿	低 提 釘 迭 澱	停 梯 鼎 鉄 田	偵 汀 泥 典 電	剃 碇 摘 填	貞 禎 擢 天	呈 程 敵 展	堤 締 滴 店	定 艇 的 添	帝 訂 笛 纏	底 諦 適 甜	庭 蹄 鎬 貼	廷 逦 溺 転	弟 哲 顛
ト	935F 936F 9380 9390 939E 93AE 93BE 93CE	登 凍 盜 動 得 鳶	菟 刀 淘 董 同 德 苦	賭 唐 湯 蕩 堂 洗 寅	途 塔 涛 藤 導 特 酉	都 塘 灯 討 憧 督 瀨	兔 砥 宕 当 豆 洞 篤 屯	吐 砺 島 痘 踏 瞳 毒 惇	堵 努 嶋 禱 逃 童 独 敦	塗 度 悼 等 透 胴 読 沌	妬 土 投 答 鏡 苟 析 豚	屠 奴 搭 筒 陶 道 橡 遁	徒 怒 東 糖 頭 銅 凸 頓	斗 倒 桃 統 騰 峠 突 吞	杜 党 禱 到 鬪 鴉 椀 曇	渡 冬 棟 働 匿 届 鈍	
ナ	93DE 93EE	奈 軟	那 難	内 汝	乍	凧	薙	謎	灘	捺	鍋	檜	馴	繩	啜	南	楠
ニ	93EE 943F		如 尿	二 菲		尼 任	弍 妊	迹 忍	匂 認	賑	肉	虹	廿	日	乳	入	
ヌ	943F									濡							
ネ	943F 944F	念	捻	燃	燃	粘					禰	祢	寧	葱	猫	熱	年
ノ	944F 945F	農	覗	蚤			乃	迺	之	埜	囊	惱	濃	納	能	腦	膿
ハ	945F 946F 9480 9490 949E 94AE	俳 楳 柏 醜	糜 煤 泊 函 髮	拝 狼 白 箱 箱 伐	巴 排 買 箔 砒 罰	把 敗 売 粕 箸 拔	播 杯 賠 賠 薄 肇 箬 筏	霸 盃 陪 薄 箬 閥	把 牌 這 迫 櫨 鳩	波 背 蠅 曝 肌 塙 嘶	派 肺 秤 漠 肌 塙	琶 輩 矧 爆 焮 焮 隼	破 配 菽 縛 畠 隼	婆 倍 伯 莫 八 伴	罵 培 剥 駁 鉢 判	芭 媒 博 麥 澆 澆 半	馬 梅 拍 癸 反

	ShiftJIS	0	1	2	3	4	5	6	7	8	9	A	B	C	D	E	F
ハ	94BE 94CE	叛 采	帆 煩	搬 頒	斑 飯	板 挽	汜 晚	汎 番	版 盤	犯 磬	班 蕃	畔 蛮	繁	般	藩	販	範
ヒ	94CE 94DE 94EE 953F 954F 955F 956F	彼 誹	悲 費 鼻 姪 描 頻	扉 避 柎 媛 病 敏	批 非 稗 紐 sec 瓶	披 飛 匹 百 苗	斐 樋 疋 謬 錨	比 簸 髭 倭 鋌	泌 備 彦 彪 蒜	疲 尾 膝 標 蛭	皮 微 菱 氷 緒	碑 枇 肘 漂 品	匪 秘 毘 弼 瓢 彬	卑 緋 毘 必 票 斌	否 罷 眉 畢 表 浜	妃 肥 美 筆 評 瀨	庇 被 逼 豹 貧
フ	956F 9580 9590 959E 95AE	斧 武 憤	普 舞 福 扮	浮 葡 腹 焚	父 蕪 複 奮	不 符 部 覆 粉	付 腐 封 淵 糞	埠 膚 楓 弗 紛	夫 芙 風 弘 霧	婦 譜 葦 沸 文	富 負 落 仏 聞	富 賦 伏 物	布 赴 副 鮒	府 阜 復 分	怖 附 幅 吻	扶 侮 服 噴	敷 撫 墳
ヘ	95AE 95BE 95CE	弊 偏	柄 変	並 片	蔽 篇	閉 編	陛 辺	米 返	頁 遍	僻 便	壁 勉	丙 癖 婉	併 碧 弁	兵 別 鞭	塀 警	幣 蔑	平 篋
ホ	95CE 95DE 95EE 963F 964F 965F 966F	圃 俸 飽 棒 撲	捕 包 法 鳳 冒 朴	步 呆 泡 鵬 紡 牧	甫 報 烹 乏 肪 睦	補 奉 砲 亡 膨 穆	輔 宝 縫 傍 謀 釦	穗 峰 胞 剖 貌 勃	募 峯 芳 坊 貿 没	墓 崩 萌 妨 鉾 殆	慕 庖 蓬 帽 防 堀	戊 抱 蜂 忘 吠 幌	暮 捧 褒 忙 類 奔	母 放 訪 房 北 本	保 簿 方 豐 暴 僕 翻	舖 菩 朋 邦 望 卜 凡	鋪 做 鋒 某 墨 盆
マ	9680 9690 969E	摩 鱒	磨 榭 漫	魔 亦 蔓	麻 俣	埋 又	妹 抹	昧 末	枚 沫	每 迄	哩 俛	禛 繭	幕 磨	膜 万	枕 慢	鮪 滿	枉
ミ	969E 96AE	耗 民	眠	味	未 魅	巳 箕	岬 密	蜜 湊	蓑 稔	脈 妙							
ム	96AE			務	夢 無	牟 矛	霧 鷓	棕 婿	娘								
メ	96AE 96BE	明	盟 迷	銘	鳴 姪	牝 滅	免 棉	綿 緬	冥 名 命					面 麵			
モ	96BE 96CE	茂 妄	孟	毛	猛 盲	網 耗	蒙 儲	木 默	目 杳						摸 勿	模 餅	

	ShiftJIS	0	1	2	3	4	5	6	7	8	9	A	B	C	D	E	F
モ	96DE	尤	戾	粃	貰	問	悶	紋	門	匆							
ヤ	96DE 96EE	矢	厄	役	約	菓	訊	躍	靖	柳	也	冶	夜	爺	耶	野	弥
ユ	96EE 973F 974F	涌	諭	輸	唯	佑	優	勇	友	宥	幽	悠	愉	愈	油	癒	湧
ヨ	974F 975F 976F 9780	誉	輿	預	傭	幼	妖	容	庸	揚	搖	擁	曜	楊	樣	洋	欲
ラ	9780 9790	乱	卵	嵐	欄	濫	羅	螺	裸	来	莱	頼	雷	洛	絡	落	酪
リ	9790 979E 97AE 97BE 97CE	琉	痲	裏	裡	里	離	陸	律	利	吏	履	李	梨	理	璃	溜
ル	97CE 97DE	類	寮	料	涼	淋	龍	瞭	稜	率	立	了	掠	略	僚	流	凌
レ	97DE 97EE 983F	齡	令	伶	例	冷	勵	嶺	伶	玲	礼	苓	鈴	隸	零	靈	麗
ロ	983F 984F 985F	樓	榔	浪	漏	呂	魯	櫓	炉	賂	路	露	勞	婁	廊	弄	朗
ワ	985F 986F	椀	倭	和	話	歪	賄	脇	惑	梓	鷺	互	亘	鰐	詫	藁	蕨

	ShiftJIS	0	1	2	3	4	5	6	7	8	9	A	B	C	D	E	F	
一	989E		弋	丐	丕													
丨	989E					个	卩											
丶	989E							丶	井									
丿	989E									丿	乂	乖	乘					
乙	989E													亂				
丿	989E 98AE														丿	豫	事	
二	98AE		式	于	亞	亟												
十	98AE					十	亢	京		毫	亶							
人	98AE											从	仍	仄	仆	仂	仗	
	98BE	仞	仞	仞	价	伉	侏	估	佛	佝	佗	侗	佶	仄	侏	侗	仗	
	98CE	佩	佰	侑	伴	來	侖	儘	倪	俟	俎	侗	俛	侑	侑	侑	侑	
	98DE	俾	倚	倨	倨	倪	倨	倨	倨	俶	倡	侑	俛	倨	倨	倨	倨	倨
	98EE	偃	假	會	偃	倨	倨	倨	倨	倨	倨	倨	倨	倨	倨	倨	倨	倨
	993F 994F	儼	僉	僉	僉	僉	僉	僉	僉	僉	僉	僉	僉	僉	僉	僉	僉	僉
儿	994F									儿	兀	兒		兌	免	兢	競	
入	995F	兩	兪															
八	995F			兮	冀													
冂	995F					冂	回	册	冉	冂	冂	冂	冂					
冂	995F													冂	冤	冠	冂	
	996F	寫	冂															
丷	996F			丷	决	冂	冲	冰	况	冽	涸	凉	凜					
几	996F													几	處	夙	凭	
	9980																	
凵	9980		凵	凵														
刀	9980				刃	刊	刂	刂	刂	刪	刮	刮	剝	剝	剝	剝	剝	
	9990	劊	剔	剪	劊	剩	劊	劊	劊	劊	劊	劊	劊	劊	劊	劊	劊	
	999E		剔	辦														
力	999E			劬	劬	劬	劬	劬	劬	劬	勞	勸	勸	劬	劬	勸	勸	
	99AE	勸																
勹	99AE		勹	匆	匈	匈	匍	匍	匍									
七	99AE									七								
匚	99AE										匚	匚	匚	匚	匚			

	ShiftJIS	0	1	2	3	4	5	6	7	8	9	A	B	C	D	E	F	
匸	99AE																匸 區	
十	99BE	卅	卅	卅	卅	卅	卅	卅	卅									
卜	99BE								卞									
冂	99BE								冂	卮	卮	卮	卮					
厂	99BE 99CE													厂	厖	厖	厦	
厶	99CE				厶	參	篡											
又	99CE							雙	叟	曼	變							
口	99CE 99DE 99EE 9A3F 9A4F 9A5F 9A6F 9A80 9A90	呀 咒 嗽 啣 嚼	听 呻 呖 啞 嗚 囁	吭 咀 晒 啣 嘔 囁	吼 呶 啞 啞 啞 囁	吮 咄 咄 售 嘖 囁	呐 咐 咄 嚼 單 嘖 囁	吝 哇 哥 啞 啞 啞 囁	呖 呖 呖 啞 啞 啞 啞	咏 咸 唏 唸 唸 噓 噓	叮 呵 啞 啞 啞 噓 噓	叨 咎 咬 啞 啞 啞 嚙	叭 呖 哄 哮 啞 嚙 嚙	叭 呱 哈 哭 啞 啞 嚙	吁 呖 咨 哭 啞 啞 嚙	咄 咄 咄 咄 咄 咄 咄	咄 咄 咄 咄 咄 咄 咄	
口	9A90 9A9E									口	囧	囧	囧	囧	囧	囧		
土	9A9E 9AAE 9ABE 9ACE 9ADE	坩 埤 墅 壘	垂 壘 壘 壘	垚 垚 墟 壘	坡 垚 垚 壘	坩 坩 壘 壘	垚 垚 壘 壘	垚 垚 壘 壘	垚 垚 壘 壘	坩 垚 壘 壘	坩 垚 壘 壘	坩 垚 壘 壘	坩 垚 壘 壘	坩 垚 壘 壘	坩 垚 壘 壘	坩 垚 壘 壘	坩 垚 壘 壘	坩 垚 壘 壘
士	9ADE				壯	壺	壺	壺	壺	壽								
夕	9ADE									夕								
夕	9ADE										夕	夂						
夕	9ADE													夕	夕	夕	夕	
大	9ADE 9AEE	夭	本	夸	夾	奇	奕	奂	奎	奚	奘	奢	奠	奧	獎	奘	夫	
女	9B3F 9B4F 9B5F 9B6F	娑 媽 孃	奸 娜 媽 孃	妁 娉 媽 孃	妝 娉 媽 孃	佞 姍 嫩	佞 姍 嫵	妣 姍 嫵	妣 姍 嫵	姆 娶 嬌	姨 婢 嬋	姜 婪 嬋	妍 媚 嬋	姘 媼 嬋	姚 媼 嬋	娥 媼 嬋	娟 媼 嬋	

	ShiftJIS	0	1	2	3	4	5	6	7	8	9	A	B	C	D	E	F
子	9B6F				子	孕	孚	孛	孛	孩	孰	孳	孳	學	孳	孺	
宀	9B6F 9B80 9B90	它 寶	宦	宸	寃	寇	霍	寔	寐	寤	實	寢	寔	寥	寫	寰	寶
寸	9B90		尅	將	專	對											
小	9B90						尔	尠									
尢	9B90							尢		尢							
尸	9B90 9B9E		屣	屏	屨	屬				尸	尹	屨		屨	屨	屨	
山	9B9E 9BAE 9BBE 9BCE	岬	岷	岷	岷	岷	岷	岷	岷	岷	岷	岷	岷	岷	岷	岷	岷
巛	9BCE																巛
工	9BDE	巫															
巳	9BDE		巳	卮													
巾	9BDE 9BEE	幟	幟	幣	幣	幣	帑	帑	帑	帶	帷	幄	幃	幃	幃	幃	幃
干	9BEE					干	井										
幺	9BEE						么	麼									
广	9BEE 9C3F		廖	廣	廡	廡	廡	廡		广	庠	廁	廂	厦	廡	廡	廡
廴	9C3F																廴 廴
廾	9C4F	廾	弃	廾	廾	廾											
弋	9C4F						弋	弋									
弓	9C4F							弓		弩	弭	弭	弭	彈	彌	彎	彎
彡	9C5F	彡	彡	彡	彡												
彣	9C5F					彣	彭										
彣	9C5F 9C6F	徙	徙	徠	徠	徠	徠	徠	徠	徠	徠	徠	徠	徠	徠	徠	徠
心	9C6F 9C80 9C90	怙	恂	怩	恚	怙	怙	怙	怙	忤	忤	忤	忤	惠	恂	怡	恂

	ShiftJIS	0	1	2	3	4	5	6	7	8	9	A	B	C	D	E	F
心	9C9E 9CAE 9CBE 9CCE 9CDE 9CEE	悵 愜 慚 慚 慚	惘 惘 愜 慚 慚	悛 悛 慚 慚 慚	悛 悛 悛 悛 悛	悛 悛 悛 悛 悛	悛 悛 悛 悛 悛	悛 悛 悛 悛 悛	悛 悛 悛 悛 悛	惡 悛 悛 悛 悛	悛 悛 悛 悛 悛	悛 悛 悛 悛 悛	悛 悛 悛 悛 悛	悛 悛 悛 悛 悛	悛 悛 悛 悛 悛	悛 悛 悛 悛 悛	悛 悛 悛 悛 悛
戈	9CEE 9D3F		戛 戛 戛	戛 戛 戛	戛 戛 戛	戛 戛 戛	戛 戛 戛	戛 戛 戛	戛 戛 戛		戈 戈 戈	戈 戈 戈	戈 戈 戈	戈 戈 戈	戈 戈 戈	戈 戈 戈	戈 戈 戈
戶	9D3F									扁							
手	9D3F 9D4F 9D5F 9D6F 9D80 9D90 9D9E 9DAE	扌 扌 扌 扌 扌 扌 扌 扌	扌 扌 扌 扌 扌 扌 扌 扌	扌 扌 扌 扌 扌 扌 扌 扌	扌 扌 扌 扌 扌 扌 扌 扌	扌 扌 扌 扌 扌 扌 扌 扌	扌 扌 扌 扌 扌 扌 扌 扌	扌 扌 扌 扌 扌 扌 扌 扌	扌 扌 扌 扌 扌 扌 扌 扌	扌 扌 扌 扌 扌 扌 扌 扌	扌 扌 扌 扌 扌 扌 扌 扌	扌 扌 扌 扌 扌 扌 扌 扌	扌 扌 扌 扌 扌 扌 扌 扌	扌 扌 扌 扌 扌 扌 扌 扌	扌 扌 扌 扌 扌 扌 扌 扌	扌 扌 扌 扌 扌 扌 扌 扌	扌 扌 扌 扌 扌 扌 扌 扌
支	9DAE 9DBE	攴 攴 攴	攴 攴 攴	攴 攴 攴	攴 攴 攴	攴 攴 攴	攴 攴 攴	攴 攴 攴	攴 攴 攴	攴 攴 攴	攴 攴 攴	攴 攴 攴	攴 攴 攴	攴 攴 攴	攴 攴 攴	攴 攴 攴	攴 攴 攴
斗	9DBE 9DCE	斛															斛
斤	9DCE	斫 斫	斫 斫	斫 斫	斫 斫	斫 斫	斫 斫	斫 斫	斫 斫								
方	9DCE		旃 旃	旃 旃	旃 旃	旃 旃	旃 旃	旃 旃	旃 旃	旃 旃	旃 旃	旃 旃	旃 旃				
无	9DCE												无	无			
日	9DCE 9DDE 9DEE 9E3F	曷 曷 曷 曷	曷 曷 曷 曷	曷 曷 曷 曷	曷 曷 曷 曷	曷 曷 曷 曷	曷 曷 曷 曷	曷 曷 曷 曷	曷 曷 曷 曷	曷 曷 曷 曷	曷 曷 曷 曷	曷 曷 曷 曷	曷 曷 曷 曷	曷 曷 曷 曷	曷 曷 曷 曷	曷 曷 曷 曷	曷 曷 曷 曷
日	9E3F									日 日 日	日 日 日	日 日 日	日 日 日				
月	9E3F 9E4F	朙 朙	朙 朙	朙 朙	朙 朙	朙 朙	朙 朙	朙 朙	朙 朙					朙 朙 朙	朙 朙 朙	朙 朙 朙	朙 朙 朙
木	9E4F 9E5F 9E6F	杝 杝 杝	杝 杝 杝	杝 杝 杝	杝 杝 杝	杝 杝 杝	杝 杝 杝	杝 杝 杝	杝 杝 杝	杝 杝 杝	杝 杝 杝	杝 杝 杝	杝 杝 杝	杝 杝 杝	杝 杝 杝	杝 杝 杝	杝 杝 杝



	ShiftJIS	0	1	2	3	4	5	6	7	8	9	A	B	C	D	E	F	
木	9E80	梳	柁	杵	档	桷	梃	梃	梃	梭	梃	條	椰	挺	檣	椈	桴	
	9E90	梵	柁	杵	桷	桷	梃	梃	梃	柁	棘	梃	椰	梃	梃	椈	桴	
	9E9E		柁	杵	桷	桷	梃	梃	梃	柁	柁	梃	椰	梃	梃	椈	桴	
	9EAE	椈	柁	杵	桷	桷	梃	梃	梃	柁	柁	梃	椰	梃	梃	椈	桴	
	9EBE	椈	柁	杵	桷	桷	梃	梃	梃	柁	柁	梃	椰	梃	梃	椈	桴	
	9ECE	椈	柁	杵	桷	桷	梃	梃	梃	柁	柁	梃	椰	梃	梃	椈	桴	
	9EDE	椈	柁	杵	桷	桷	梃	梃	梃	柁	柁	梃	椰	梃	梃	椈	桴	
	9EEE	椈	柁	杵	桷	桷	梃	梃	梃	柁	柁	梃	椰	梃	梃	椈	桴	
	9F3F		椈	柁	杵	桷	桷	梃	梃	梃	柁	柁	梃	椰	梃	梃	椈	桴
	9F4F		椈	柁	杵	桷	桷	梃	梃	梃	柁	柁	梃	椰	梃	梃	椈	桴
欠	9F4F								欸	欸	盜	欸	飲	歇	歇	歉	歐	
	9F5F	欸	欸	欸	欸	歡												
止	9F5F					歸												
歹	9F5F						歹	殄	殄	殄	殄	殄	殄	殄	殄	殄	殄	
	9F6F	殄	殄	殄	殄	殄												
殳	9F6F					殳	殳	殳	殳	殳								
母	9F6F									母	毓							
毛	9F6F											毛	毳	毳	毳	毳	毳	
	9F80	毳	毳															
氏	9F80			氏														
气	9F80			气		氛	氫	氣										
水	9F80							汞	汕	汕	汪	沂	沔	沔	沔	沛	沛	
	9F90	汾	汨	汨	沒	沐	泄	決	汕	汕	汪	沂	沔	沔	沔	沛	沛	
	9F9E		汨	汨	沒	沐	泄	決	汕	汕	汪	沂	沔	沔	沔	沛	沛	
	9FAE	洌	汨	汨	沒	沐	泄	決	汕	汕	汪	沂	沔	沔	沔	沛	沛	
	9FBE	洌	汨	汨	沒	沐	泄	決	汕	汕	汪	沂	沔	沔	沔	沛	沛	
	9FCE	洌	汨	汨	沒	沐	泄	決	汕	汕	汪	沂	沔	沔	沔	沛	沛	
	9FDE	洌	汨	汨	沒	沐	泄	決	汕	汕	汪	沂	沔	沔	沔	沛	沛	
	9FEE	洌	汨	汨	沒	沐	泄	決	汕	汕	汪	沂	沔	沔	沔	沛	沛	
	E03F	洌	汨	汨	沒	沐	泄	決	汕	汕	汪	沂	沔	沔	沔	沛	沛	
	E04F	洌	汨	汨	沒	沐	泄	決	汕	汕	汪	沂	沔	沔	沔	沛	沛	
E05F	洌	汨	汨	沒	沐	泄	決	汕	汕	汪	沂	沔	沔	沔	沛	沛		
E06F	洌	汨	汨	沒	沐	泄	決	汕	汕	汪	沂	沔	沔	沔	沛	沛		
火	E06F					炙	炒	炯	炯	炬	炸	炳	炳	炮	烟	焦	焦	

	ShiftJIS	0	1	2	3	4	5	6	7	8	9	A	B	C	D	E	F
火	E080 E090 E09E	烙 煩	焉 熨 燹	烽 熬 燿	焜 爛 爍	焙 烹 爐	煥 熾 爛	熙 燒 爨	熙 燉	煦 燂	煢 燎	煌 燠	煖 燉	煬 燧	熏 燧	燻 燼	熇
爪	E09E								爭	爬	爰	爲					
爻	E09E												爻	俎			
爿	E09E E0AE	牋	牘												爿	牀	牆
牛	E0AE		牴	牾		犁	犁	犛	犒	犖	犢	犛					
犬	E0AE E0BE E0CE	狎 猥	狒 猥	狒 獒	狼 獾	狡 默	狹 獾	狷 獾	倏 獨	猗 猗	猗 猗	猜 猗	猗 猗	豺 獾	狃 猗	狃 猗	狃 猗
王	E0CE E0DE E0EE	玻 瑁	珀 瑜	珥 瑩	珮 瑰	珞 瑣	璠 瑪	琅 瑤	瑯 瑾	琥 璋	瑀 璞	琲 璧	琲 瓊	瑕 瓊	玳 瓊	玳 瓊	玳 瓊
瓜	E13F		瓠	瓣													
瓦	E13F E14F				甌	甌	瓮	甌	甌	甌	甌	甌	甌	甌	甌	甌	甌
甘	E14F				嘗												
生	E14F					甦											
用	E14F						甬										
田	E14F E15F	畧	畫	畎	畸	當	疆	旱	疇	畎	畎	畎	畎	畎	畎	畎	畎
疒	E15F E16F E180 E190 E19E	痂 痂 癩	疔 瘁 癩	疔 癩 癩	疔 癩 癩	疔 癩 癩	疔 癩 癩	疔 癩 癩	疔 癩 癩	疔 癩 癩	疔 癩 癩	疔 癩 癩	疔 癩 癩	疔 癩 癩	疔 癩 癩	疔 癩 癩	疔 癩 癩
火	E19E		火	癸	發												
白	E19E					皂	兒	飯		皋	皎	皖	皓	皙	皚		
皮	E19E E1AE		鞞	輝	皴											皴	皴
皿	E1AE				孟	盍	盍	盒	盞	盞	盞	盞	盞	盞			
目	E1AE E1BE	眇	眩	昵	眞	眚	眚	昧	眷	眸	睇	睇	睇	睇	眇	眇	眇

	Shift JIS	0	1	2	3	4	5	6	7	8	9	A	B	C	D	E	F
目	E1CE E1DE	睽 轟	睹 矚	瞎 矚	瞋	瞑	瞠	瞞	瞰	瞶	瞷	瞿	瞵	瞽	瞻	矚	矚
矛	E1DE			矜													
矢	E1DE				矣	矮											
石	E1DE E1EE E23F	砗	砗	砗	砗	砗	砗	砗	砗	砗	砗	砗	砗	砗	砗	砗	砗
示	E23F E24F	祕	祕	祕	祕	祕	祕	祕	祕	禪	禮	禳	祀	祠	祗	崇	祚
禺	E24F												禹	禺			
禾	E24F E25F E26F	秬	秬	秬	秬	稍	秬	秬	秬	稟	稟	稱	稻	稟	稷	秣	秣
穴	E26F E280	窶	窶	窶	窶	邃	竇	窶	竇	窶	窗	窶	窶	窶	窩	窶	窶
立	E280 E290	竝	竝	竝					竝	竝	竝	竝	竝	竝	竝	竝	竝
竹	E290 E29E E2AE E2BE E2CE E2DE	筵	筵	筵	筵	筵	筵	筵	筵	筵	筵	筵	筵	筵	筵	筵	筵
米	E2DE E2EE	糝	糝	糝	糝	粿	粿	粿	粿	粿	粿	粿	粿	粿	粿	粿	粿
糸	E2EE E33F E34F E35F E36F E380 E390	絨	絨	絨	絨	絨	絨	絨	絨	絨	絨	絨	絨	絨	絨	絨	絨
缶	E390 E39E	罇	罇	罇	罇	罇	罇							罇	罇		

	ShiftJIS	0	1	2	3	4	5	6	7	8	9	A	B	C	D	E	F
网	E39E E3AE	絹	罷	羈	羈	羈	网	罕		罔	罟	罟	罟	罟	罟	罟	罟
羊	E3AE E3BE	羸	羸				羴	羴	羴	羴	羴	羴	羴	羴	羴	羴	羴
羽	E3BE			翊	翠	翊	翕	翔	翦	翦	翦	翦	翦	翦	翦	翦	翦
老	E3BE														耆	耄	耄
耒	E3CE	耒	耘	耜	耜	耒	耒										
耳	E3CE E3DE	聳	聳	聳	聳	聳	聳	聳	聳	聳	聳	聳	聳	聳	聳	聳	聳
聿	E3DE						聿	聿		聿	聿						
肉	E3DE E3EE E43F E44F E45F	胛	胛	胛	胛	胛	胛	胛	胛	胛	胛	胛	胛	胛	胛	胛	胛
臣	E45F									臧							
至	E45F										臺	臻					
臼	E45F E46F	與	舊											與	與	與	與
舌	E46F		舍	舐		舖											
舟	E46F E480	舫	舫	舫	舫	舫	舫	舫	舫	舫	舫	舫	舫	舫	舫	舫	舫
艮	E480					艮											
艸	E480 E490 E49E E4AE E4BE E4CE E4DE E4EE E53F E54F	苜	苜	苜	苜	苜	苜	苜	苜	艾	艾	艾	艾	艾	艾	艾	艾

	Shift JIS	0	1	2	3	4	5	6	7	8	9	A	B	C	D	E	F
艸	E55F	蘋	蘋	藺	蘆	龍	蘇	藎	蘿								
虍	E55F									虍	虍	虍	虍	虍			
虫	E55F														虱	虵	蚣
	E56F	蚩	蚪	蚋	蚌	蚶	蚯	蛄	蛆	蚰	蛉	螞	蛇	蛔	蛞	蛎	蚣
	E580	蛟	蛛	蛸	蛭	蛭	蜈	蜀	蠶	蛻	蛻	蛻	蛻	蝮	蝮	蝮	蝮
	E590	蝮	蜻	蜥	蜥	蜥	蝠	蝟	蝟	蝟	蝟	蝟	蝟	蝟	蝟	蝟	蝟
	E59E		蝮	蝮	蝮	蝮	蝮	蝮	蝮	蝮	蝮	蝮	蝮	蝮	蝮	蝮	蝮
	E5AE	蝮	蝮	蝮	蝮	蝮	蝮	蝮	蝮	蝮	蝮	蝮	蝮	蝮	蝮	蝮	蝮
	E5BE	蝮	蝮	蝮	蝮	蝮	蝮	蝮	蝮	蝮	蝮	蝮	蝮	蝮	蝮	蝮	蝮
血	E5BE									衄	衄						
行	E5BE											衞	衞	衞	衞		
衣	E5BE															衫	袁
	E5CE	衾	衾	衾	衾	衾	衾	衾	衾	衾	衾	衾	衾	衾	衾	衾	衾
	E5DE	袂	袂	袂	袂	袂	袂	袂	袂	袂	袂	袂	袂	袂	袂	袂	袂
	E5EE	袂	袂	袂	袂	袂	袂	袂	袂	袂	袂	袂	袂	袂	袂	袂	袂
	E63F	袂	袂	袂	袂	袂	袂	袂	袂	袂	袂	袂	袂	袂	袂	袂	袂
而	E63F									而	而	而	而				
見	E63F													覓	覓	覓	覓
	E64F	覓	覓	覓	覓	覓	覓	覓	覓	覓	覓	覓	覓	覓	覓	覓	覓
角	E64F									觚	觚	觚	觚	觚	觚		
言	E64F															訃	訃
	E65F	訃	訃	訃	訃	訃	訃	訃	訃	訃	訃	訃	訃	訃	訃	訃	訃
	E66F	訃	訃	訃	訃	訃	訃	訃	訃	訃	訃	訃	訃	訃	訃	訃	訃
	E680	訃	訃	訃	訃	訃	訃	訃	訃	訃	訃	訃	訃	訃	訃	訃	訃
	E690	訃	訃	訃	訃	訃	訃	訃	訃	訃	訃	訃	訃	訃	訃	訃	訃
	E69E	訃	訃	訃	訃	訃	訃	訃	訃	訃	訃	訃	訃	訃	訃	訃	訃
谷	E69E															谷	谷
	E6AE	谷															
豆	E6AE		豈	豈	豈	豈	豈	豈	豈								
豕	E6AE						豕	豕	豕								
豸	E6AE									豸	豸	豸	豸	豸	豸	豸	豸
	E6BE	豸	豸	豸										豸	豸	豸	豸
貝	E6BE				賤	賤	賤	賤	賤	貳	貳	貳	賈	賈	賈	賈	賈
	E6CE	賈	賈	賈	賈	賈	賈	賈	賈	賈	賈	賈	賈	賈	賈	賈	賈

	ShiftJIS	0	1	2	3	4	5	6	7	8	9	A	B	C	D	E	F
赤	E6CE E6DE	赭															赧
走	E6DE	志	赳	赳	赳	趙											
足	E6DE E6EE E73F E74F	跟	跣	跣	跣	跟	跣	跣	跣	跣	跣	跣	跣	跣	跣	跣	跣
身	E74F E75F	軀	軀										躬	軀	軀	軀	軀
車	E75F E76F E780	輟	輟	輟	輟	輟	輟	輟	輟	輟	輟	輟	輟	輟	輟	輟	輟
辛	E780				辜	辟	辣	辭	辯								
辵	E780 E790 E79E E7AE	迓	迹	迓	迓	迓	迓	迓	迓	迓	迓	迓	迓	迓	迓	迓	迓
邑	E7AE E7BE	鄒	鄒	鄒	鄒				邨	邨	邨	邨	邨	邨	邨	邨	邨
酉	E7BE E7CE	醫	醢	醢	醢	醢	醢	醢	醢	醢	醢	醢	醢	醢	醢	醢	醢
采	E7CE									糶	釋						
里	E7CE												釐				
金	E7CE E7DE E7EE E83F E84F E85F E86F	釵	鉞	鉞	鉞	鈔	鈔	鈔	鈔	鈔	鈔	鈔	鈔	鈔	鈔	鈔	鈔
門	E86F E880 E890	閨	閨	閨	閨	閨	閨	閨	閨	閨	閨	閨	閨	閨	閨	閨	閨
阜	E890					阡	阡	阡	阡	阡	阡	阡	阡	阡	阡	阡	阡

	Shift JIS	0	1	2	3	4	5	6	7	8	9	A	B	C	D	E	F
阜	E89E		陝	陟	陟	陞	陞	陞	陞	隕	隗	險	隧	隱	隲	隳	隳
隶	E8AE	隶	隸														
佳	E8AE			佳	隹	雉	雍	襍		雜	霍	雕					
雨	E8AE											雹	霄	霏	霏	霏	霏
	E8BE	霏	霏	霏	霖	霏	雷	霏	霏	霹	霽	霏	霏	霏	霏	霏	霏
青	E8CE	靜															
非	E8CE		靠														
面	E8CE			面	靨												
革	E8CE					勒	鞞	鞞	鞞	鞞	鞞	鞞	鞞	鞞	鞞	鞞	鞞
	E8DE	鞞	鞞	鞞	鞞	鞞	鞞	鞞	鞞	鞞	鞞	鞞	鞞	鞞	鞞	鞞	鞞
韋	E8DE											韋	韋				
韭	E8DE													韭	韭	韭	
音	E8DE																竟
	E8EE	韶	韻														
頁	E8EE		頤	頤	頤	頤	頤	頤	頤	頤	頤	頤	頤	頤	頤	頤	頤
	E93F	頤	頤	頤	頤												
風	E93F					風	颯	颯	颯	飄	颯	颯					
食	E93F					餞	餞	餅	餞	餞	餞	餞	餞	餞	餞	餞	餞
	E94F	餞	餞	餞	餞	餞	餞	餞	餞	餞	餞	餞	餞	餞	餞	餞	餞
	E95F	餞	餞	餞	餞												
首	E95F				馗	馗											
香	E95F					馥											
馬	E95F							馭		馮	馮	馮	馮	馮	馮	馮	馮
	E96F	馮	馮	馮	馮	馮	馮	馮	馮	馮	馮	馮	馮	馮	馮	馮	馮
	E980	馮	馮	馮	馮	馮	馮	馮	馮	馮	馮	馮	馮	馮	馮	馮	馮
骨	E980													骸	骸	骸	骸
	E990	骸	骸	骸	骸												
高	E990					髡											
髟	E990					髟	髟	髟	髟	髟	髟	髟	髟	髟	髟	髟	髟
	E99E	髟	髟	髟	髟	髟	髟	髟	髟	髟	髟	髟	髟	髟	髟	髟	髟
鬥	E99E									鬥	鬥	鬥	鬥	鬥	鬥		
鬯	E99E																鬯
鬲	E99E																鬲
鬼	E9AE	魄	魃	魏	魃	魃	魃	魃									

	Shift JIS	0	1	2	3	4	5	6	7	8	9	A	B	C	D	E	F	
魚	E9AE E9BE E9CE E9DE	鮠 鮡 鮢 鮣	鮤 鮥 鮦 鮧	鮨 鮩 鮪 鮫	鮫 鮼 鮽 鮾	鮿 鮺 鮻 鮼	鮽 鮾 鮿 鮺	鮻 鮼 鮺 鮿	鮺 鮿 鮻 鮽	鮻 鮽 鮿 鮺	鮺 鮿 鮻 鮽	鮺 鮿 鮻 鮽	鮺 鮿 鮻 鮽	鮺 鮿 鮻 鮽	鮺 鮿 鮻 鮽	鮺 鮿 鮻 鮽	鮺 鮿 鮻 鮽	鮺 鮿 鮻 鮽
鳥	E9DE E9EE EA3F EA4F EA5F	鴈 鵞 鵝 鸚 鸚	鵞 鵝 鸚 鸚	鵞 鵝 鸚 鸚	鵞 鵝 鸚 鸚	鸚 鸚 鸚 鸚	鸚 鸚 鸚 鸚	鸚 鸚 鸚 鸚	鸚 鸚 鸚 鸚	鸚 鸚 鸚 鸚	鸚 鸚 鸚 鸚	鸚 鸚 鸚 鸚	鸚 鸚 鸚 鸚	鸚 鸚 鸚 鸚	鸚 鸚 鸚 鸚	鸚 鸚 鸚 鸚	鸚 鸚 鸚 鸚	鸚 鸚 鸚 鸚
鹵	EA5F				鹵	鹹	鹽											
鹿	EA5F						麋	麋		麋	麋	麋	麋	麋	麋	麋	麋	麋
麥	EA5F EA6F																麥	麩
麻	EA6F				靡													
黃	EA6F					覺												
黍	EA6F						黎	黏	黏									
黑	EA6F EA80	黴	黴	黴						黔	黜	黜	黜	黜	黜	黜	黜	黜
菰	EA80				菰	菰	菰											
龜	EA80						龜	龜		龜								
鼓	EA80									鼓	鼗							
鼠	EA80												鼠	鼯				
鼻	EA80															鼻		
齊	EA80															齊		
齒	EA80 EA90	齧	齧	齧	齧	齧	齧	齧	齧	齧	齧	齧	齧					齒
龍	EA90													龍				
龜	EA90														龜			
傘	EA90																傘	



10.9 2D-Code				
Available for				
	CT400/410/420	CT400-2/410-2/420-2	CT408/412/424	
<b>MAXI code</b>			<b>ESC+BV</b>	
Hexadecimal code	ESC	BV	Parameter	
	<1B> <sub>16</sub>	<42> <sub>16</sub> <56> <sub>16</sub>	a,b,c,ddddddddd,eee,fff,n~n	
Initial value	None			
Persistence of the command	When printer is powered off		Set Parameter will not be retained	
	Validity in a job		Becomes invalid after execution	
	Validity after a job		Becomes invalid after the job	

[Function]

Prints MAXI code symbols.

[Format]

<BV>a,b,c,ddddddddd,eee,fff,n~n

●Parameter

a	Position of symbol within the set	=	Valid range :	1 to 8
b	Total number of symbols in the set	=	Valid range :	1 to 8
c	Mode	=	2 :	Delivery
			3 :	Delivery
			4 :	Standard symbol
			6 :	for Reader device only
d	Postal code	=	Valid range :	0 to 99999999 (Mode 2)
				000000 to 999999 (Mode 3)
				Mode 2 accepts max. 9digits numeric only. Mode 3 accepts 6digits only (Upper case only for alphabet)
e	Country code	=	Valid range :	001 to 999
f	Service class	=	Valid range :	001 to 999
n	Low priority message	=		Alphanumeric + symbols

Mode	Service class	Country code	Postal code	Max. data size	
				Numeric	Alpha-num.
2	3 digits Fixed (Numeric only)	3 digits Fixed (Numeric only)	Max.9digits	123	84
3			6 digits fixed(Alpha-num.)		
4	Omitted			138	93
6					

[Coding Example]

```
<A>
<V>100<H>200<BV>1,1,2,123456789,001,002,SAHTHA
<Q>2
<Z>
```

[Notes]

1. The size of the symbol printed is not subject to data volume. (Quantity of data)
2. Any other parameters specified or settings being inconsistent with each other will result in no printing.
3. In case mode [4] or [6] is selected, be sure to have data size(in byte) larger than 12(byte), smaller data volume will result in failure of scanner-reading.

**MAXI Code table**

					S				I				S				O						
					b8	0	0	0	0	0	0	0	0	1	1	1	1	1	1	1	1	1	
					b7	0	0	0	0	1	1	1	1	0	0	0	0	1	1	1	1	1	
					b6	0	0	1	1	0	0	1	1	0	0	1	1	0	0	1	1	1	
					b5	0	1	0	1	0	1	0	1	0	1	0	1	0	1	0	1	0	1
B4	b3	b2	b1		0	1	2	3	4	5	6	7	8	9	A	B	C	D	E	F			
0	0	0	0	0			SP	0	@	P	`	p											
0	0	0	1	1			!	1	A	Q	a	q											
0	0	1	0	2			"	2	B	R	b	r											
0	0	1	1	3			#	3	C	S	c	s											
0	1	0	0	4			\$	4	D	T	d	t											
0	1	0	1	5			%	5	E	U	e	u											
0	1	1	0	6			&	6	F	V	f	v											
0	1	1	1	7			'	7	G	W	g	w											
1	0	0	0	8			(	8	H	X	h	x											
1	0	0	1	9			)	9	I	Y	i	y											
1	0	1	0	A			*	:	J	Z	j	z											
1	0	1	1	B			+	;	K	[	k	{											
1	1	0	0	C			,	<	L	\	l												
1	1	0	1	D			-	=	M	]	m	}											
1	1	1	0	E			.	>	N	^	n	-											
1	1	1	1	F			/	?	O	_	o	DEL											

The address can be selectable in the range 01H thru FFH for MAXI code.

10.10 2D-Code			
Available for	CT400/410/420	CT400-2/410-2/420-2	CT408/412/424i
<b>PDF417</b>		<b>ESC+BK</b>	
Hexadecimal code	ESC <1B> <sub>16</sub>	BK <42> <sub>16</sub> <4B> <sub>16</sub>	Parameter Aabbcddeefffg~g,(h)
Initial value	None		
Persistence of the command	When printer is powered off	Set parameter will not be retained	
	Validity in a job	Becomes invalid after execution	
	Validity after a job	Becomes invalid after the job	

[Function]

Specifies 2D-Code PDF417.

[Format]

<BK>aabbcddeefffg~g,(h)

●Parameter

a	Minimum module width	=	Valid range :	01 to 09 dots
b	Minimum module height	=	Valid range :	01 to 24 dots
c	Security level	=	Valid rang :	0 to 8
d	Code words per line (cols)	=	Valid range :	01 to 30
			00 :	Auto (Width auto-justified according to data quantity)
e	Rows per symbol (rows)	=	Valid range :	03 to 90
			00 :	Auto (Height auto-justified according to data quantity)
f	Number of data digits to encode	=	Valid range :	0001 to 2681
g	Data to be printed	=	Data	
h	PDF Code type	=	Not specified:	PDF417
			T :	Truncated PDF417
			M :	Micro PDF417

[Coding Example] Min. Module width: 03(dot), Min.Module height: 09(dot), Security level: 3,  
Code words per line: 03, Rows per symbol : 18

```
<A>
<V>100<H>200<BK>0309303180010PDF1234567
<Q>2
<Z>
```

[Notes]

1. Min. module width 01, 02 dot are not recommendable with a risk of lower scanner-readability.
2. Min. module height 01, 02, 03dot are not recommendable with a risk of lower scanner-readability.
3. When both "data codeword per line" and "number of data digit" are set to 00, aspect ratio (V x H) will be set automatically to 1:2.
4. Higher Security Level will require larger numbers for "rows per symbol" or "data codeword per line".
5. Maximum number of data digit is 2681. However, the number of data digit is also restricted by and subject to minimum module size, security code level and type of print data.
6. Parameters and data size being inconsistent will not print.
7. When Micro PDF417 is specified, "line per symbol" is subject to "data codeword per line", and thus, maximum number of data digit will be automatically defined. Consult the table in next page for details.
8. Security level setting is not possible for Micro PDF417.

[Tips]

1. No sequential numbering is possible for PDF417.
2. No print position setting is possible by auto-CR.
3. 00H~FFH can be specified as print data.
4. Increase minimum module dimensions for better quality, as necessary.
5. Increase Security Level for better scanner-readability, as necessary.
6. Height of print image will differ for alphabet, numeric, and alpha-numeric data.

Symbol size and Max. data digits of Micro PDF417 (Only the following 34 types are available)

Symbol size		Max. Data digits	
cols(d)	rows(e)	Alphabet (A to Z) only	Numeric only
1	11	6	8
	14	12	17
	17	18	26
	20	22	32
	24	30	44
	28	38	55
2	8	14	20
	11	24	35
	14	36	52
	17	46	67
	20	56	82
	23	64	93
3	6	10	14
	8	18	26
	10	26	38
	12	34	49
	15	46	67
	20	66	96
	26	90	132
	32	114	167
	38	138	202
	44	162	237
4	4	14	20
	6	22	32
	8	34	49
	10	46	67
	12	58	85
	15	76	111
	20	106	155
	26	142	208
	32	178	261
	38	214	313
44	250	366	

Alphabet (Upper/Lower case), Numeric, Control code may be mixed for valid combination.

Code table PDF417(Micro PDF417)

					S				I				S				O						
					b8	0	0	0	0	0	0	0	0	1	1	1	1	1	1	1	1	1	
					b7	0	0	0	0	1	1	1	1	0	0	0	0	1	1	1	1	1	
					b6	0	0	1	1	0	0	1	1	0	0	1	1	0	0	1	1	1	
					b5	0	1	0	1	0	1	0	1	0	1	0	1	0	1	0	1	0	1
b4	b3	b2	b1		0	1	2	3	4	5	6	7	8	9	A	B	C	D	E	F			
0	0	0	0	0			SP	0	@	P	`	p											
0	0	0	1	1			!	1	A	Q	a	q											
0	0	1	0	2			"	2	B	R	b	r											
0	0	1	1	3			#	3	C	S	c	s											
0	1	0	0	4			\$	4	D	T	d	t											
0	1	0	1	5			%	5	E	U	e	u											
0	1	1	0	6			&	6	F	V	f	v											
0	1	1	1	7			'	7	G	W	g	w											
1	0	0	0	8			(	8	H	X	h	x											
1	0	0	1	9			)	9	I	Y	i	y											
1	0	1	0	A			*	:	J	Z	j	z											
1	0	1	1	B			+	;	K	[	k	{											
1	1	0	0	C			,	<	L	\	l												
1	1	0	1	D			-	=	M	]	m	}											
1	1	1	0	E			.	>	N	^	n	-											
1	1	1	1	F			/	?	O	_	o	DEL											

The address can be selectable in the range 00H thru FFH for PDF417 and Micro PDF417.

10.11 2D-Code			
Available for	CT400/410/420	CT400-2/410-2/420-2	CT408i/412i/424i
<b>GS1 Data Matrix (Data)</b>		<b>ESC+BX</b>	
Hexadecimal code	ESC <1B> <sub>16</sub>	BX <42> <sub>16</sub> <58> <sub>16</sub>	Parameter aabbccddeeffghh
Initial value	None		
Persistence of the command	When printer is powered off	Set parameter will not be retained	
	Validity in a job	Becomes invalid after execution	
	Validity after a job	Becomes invalid after the job	

[Function]

Data Format of GS1 Data Matrix 2D-Code.

[Format]

<BX>aabbccddeeffghh

●Parameter

a	Format ID	= Valid range	: 01 to 06
b	Error correction level	=	00 : (ECC000)
			05 : (ECC050)
			08 : (ECC080)
			10 : (ECC100)
			14 : (ECC140)
			20 : (ECC200)
c	Cell width	= Valid range	: 01 to 16 (dot/Cell)
d	Cell height	= Valid range	: 01 to 16 (dot/Cell)
e	Number of cells per line	= Valid range	: 008 to 148
			000 : (auto-setting)
f	Number of cell lines	= Valid range	: 008 to 148
			000 : (auto-setting)
g	Mirror image	=	0 : Normal image
			1 : Mirror image
h	Guide cell thickness	= Valid range	: 01 to 15

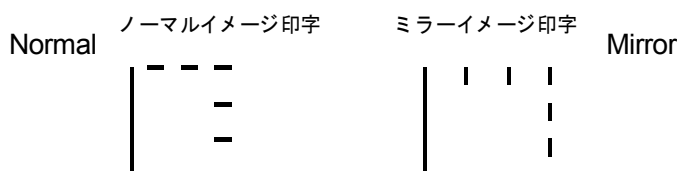

Table of Format ID

Error correction	Format ID					
	01	02	03	04	05	06
00 (ECC000)	500	452	394	413	310	271
05 (ECC050)	457	333	291	305	228	200
08 (ECC080)	402	293	256	268	201	176
10 (ECC100)	300	218	190	200	150	131
14 (ECC140)	144	105	91	96	72	63
20 (ECC200)	Numeric					3116
	Alpha-numeric					2335
	Binary (01H~FFH)					1556

The above values are the maximum data volume which the 2D code can handle for a valid coding.

[Notes]

- When error correction level is set to 20, other three settings : Format ID, Mirror image, Guide thickness will be ignored.
- Cell width, Cell height may be set to 01, 02, however may result in low scanner-read rate. 00 will cause an error.
- When 000 is specified for "the number of cells per line", or "number of cell lines", the size of the code is auto-justified according to the data to accommodate.
- Guide cell thickness for normal type code is 01.

10.12 2D-Code			
Available for	CT400/410/420	CT400-2/410-2/420-2	CT408i/412i/424i
<b>GS1 Data Matrix (Print data)</b>		<b>ESC+DC</b>	
Hexadecimal code	ESC <1B> <sub>16</sub>	DC <44> <sub>16</sub> <43> <sub>16</sub>	Parameter n~n
Initial value	None		
Persistence of the command	When printer is powered off	Set parameter will not be retained	
	Validity in a job	Becomes invalid after execution	
	Validity after a job	Becomes invalid after the job	

[Function]

Print data GS1 Data Matrix 2D-Code.

[Format]

<DC>n~n

●Parameter

n          Print data          =          Data

[Coding Example]

Format ID: 01, Error correction level: 10 (ECC100), Cell width: 02, Cell height: 02,  
 Number of the cell in one line: 000, Number of lines: 000, Mirror image: 0 (Normal),  
 Thickness of the guide-cell: 01, Print data: 1234567890

<A>

<V>100<H>200

<BX>01100202000000001

**<DC>1234567890**

<Q>2

<Z>

10.13 2D Code			
Available for	CT400/410/420	CT400-2/410-2/420-2	CT408i/412i/424i
<b>GS1 Data Matrix sequential numbering</b>		<b>ESC+FX</b>	
Hexadecimal code	ESC <1B> <sub>16</sub>	FX <46> <sub>16</sub> <58> <sub>16</sub>	Parameter aaabccdddeee
Initial value	None		
Persistence of the command	When printer is powered off	Set parameter will not be retained	
	Validity in a job	Becomes invalid after execution	
	Validity after a job	Becomes invalid after the job	

[Function]

GS1 Data Matrix. Specifies sequential numbered GS1 Data Matrix 2D symbols.

[Format]

<FX>aaabccdddeee

●Parameter

a	Number of duplicate labels	= Valid range : 001 to 999
b	Increment or decrement	= + : Increment - : Decrement
c	Increment/decrement steps	= Valid range : 001 to 999
d	Sequential numbering start position	= Valid range : 001 to 999 from left side.
e	Incremented data length. Measured from start position.	= Valid range : 001 - 999

[Coding Example] Number of duplicate labels: 001, Incremental numbering, Steps: 001, Start position: 005, Data length: 003

<A>

<V>100<H>200

**<FX>001+001005003**

<BX>01100202000000001

<DC>00006000

<Q>2

<Z>



**GS1 Data Matrix code table**

					S				I				S				O								
					<b>b8</b>	0	0	0	0	0	0	0	0	1	1	1	1	1	1	1	1	1	1	1	1
					<b>b7</b>	0	0	0	0	1	1	1	1	0	0	0	0	1	1	1	1	1	1	1	1
					<b>b6</b>	0	0	1	1	0	0	1	1	0	0	1	1	0	0	1	1	0	0	1	1
					<b>b5</b>	0	1	0	1	0	1	0	1	0	1	0	1	0	1	0	1	0	1	0	1
<b>B4</b>	<b>b3</b>	<b>b2</b>	<b>b1</b>		<b>0</b>	<b>1</b>	<b>2</b>	<b>3</b>	<b>4</b>	<b>5</b>	<b>6</b>	<b>7</b>	<b>8</b>	<b>9</b>	<b>A</b>	<b>B</b>	<b>C</b>	<b>D</b>	<b>E</b>	<b>F</b>					
0	0	0	0	<b>0</b>			SP	0	@	P	`	p													
0	0	0	1	<b>1</b>			!	1	A	Q	a	q													
0	0	1	0	<b>2</b>			"	2	B	R	b	r													
0	0	1	1	<b>3</b>			#	3	C	S	c	s													
0	1	0	0	<b>4</b>			\$	4	D	T	d	t													
0	1	0	1	<b>5</b>			%	5	E	U	e	u													
0	1	1	0	<b>6</b>			&	6	F	V	f	v													
0	1	1	1	<b>7</b>			'	7	G	W	g	w													
1	0	0	0	<b>8</b>			(	8	H	X	h	x													
1	0	0	1	<b>9</b>			)	9	I	Y	i	y													
1	0	1	0	<b>A</b>			*	:	J	Z	j	z													
1	0	1	1	<b>B</b>			+	;	K	[	k	{													
1	1	0	0	<b>C</b>			,	<	L	\	l	!													
1	1	0	1	<b>D</b>			-	=	M	]	m	}													
1	1	1	0	<b>E</b>			.	>	N	^	n	-													
1	1	1	1	<b>F</b>			/	?	O	_	o	DEL													

GS1 Data Matrix can be specified in the range 01H thru FFH.  
 To specify 7EH, write [7EH,7EH].

# 11 Graphic command

11.1 Graphic			
Available for			
	CT400/410/420	CT400-2/410-2/420-2	CT408i/412i/424i
<b>Graphic printing</b>		<b>ESC+G</b>	
Hexadecimal code	ESC <1B> <sub>16</sub>	G <47> <sub>16</sub>	Parameter abbbccn~n
Initial value	None		
Persistence of the command	When printer is powered off	Set parameter will not be retained	
	Validity in a job	Becomes invalid after execution	
	Validity after a job	Becomes invalid after the job	

**[Function]**

Allows creation and printing of graphic images using a dot-addressable matrix.

**[Format]**

<G>abbbccn~n

•Parameter

- a        Specifies format of data stream to follow
  - H: Hexadecimal    8bit data divided into 2 blocks of 4bit and output in a ASCII-based Hexadecimal code.
  - B: \*Binary        8bit data is handled as 1font data and output in a chunk.
- b        Width of the graphic area    = see table below for valid range
- c        Height of the graphic area   = see table below for valid range
- n        Graphic data

**[Coding Example]**

```
<A>
<V>50<H>50<G>H02000288888888...8888
<Q>2
<Z>
```

**[Notes]**

1. "B"Binary format is advantageous to "H" in terms of total data length being 1/2, though it needs prolix programming.
2. The rotation command<%>, expansion command<L> can be used in combination with this command.

**[Valid range]**

Model	Max. width (byte)	Max.Height (byte)
CT400DT/TT	104	400
CT410DT/TT	156	600
CT420DT/TT	312	999
CT400-2DT/TT	104	400
CT410-2DT/TT	156	600
CT420-2DT/TT	312	999
CT408iDT/TT	104	400
CT412iDT/TT	156	600
CT424iDT/TT	312	999

11.2 Graphic			
Available for	CT400/410/420	CT400-2/410-2/420-2	CT408i/412i/424i
<b>BMP file printing</b>		<b>ESC+GM</b>	
Hexadecimal code	ESC <1B> <sub>16</sub>	GM <47> <sub>16</sub> <4D> <sub>16</sub>	Parameter aaaaa,n~n
Initial value	None		
Persistence of the command	When printer is powered off	Set parameter will not be retained	
	Validity in a job	Becomes invalid after execution	
	Validity after a job	Becomes invalid after the job	

[Function]

Downloads BMP File (typically created on Windows Paint brush) to the internal graphics image memory to print.

[Format]

<GM>aaaaa,n~n

●Parameter

a       Quantity of bytes to download  
n       Graphic data

[Coding Example]

```
<A>
<V>50<H>50<GM>04500,200028888888...8888
<Q>2
<Z>
```

[Notes]

1. The data is transmitted in binary (8bit/1font data). Actual size of BMP file is the value to parameter "a".
2. BMP file consists of the header part (the first 62 byte) and compressed graphic data.
3. If the total quantity of bytes of a BMP file is not consistent with actual data being sent, it may result in an operation failure.
4. The total quantity of byte is displayed in the property of the file.
5. BMP file can be used only in black/white mode. A BMP file in color mode will result in a command error and no printing.  
The command does not support compressed type of the BMP file. Make sure that file extension is BMP before printing.
6. Rotation<%>, Expansion<L> can be used in combination with this command.
7. Expansion<L> should be specified immediately before BMP file printing<GM>.

11.3 Graphic			
Available for	CT400/410/420	CT400-2/410-2/420-2	CT408i/412i/424i
<b>PCX file printing</b>		<b>ESC+GP</b>	
Hexadecimal code	ESC <1B> <sub>16</sub>	GP <47> <sub>16</sub> <50> <sub>16</sub>	Parameter aaaaa,n~n
Initial value	None		
Persistence of the command	When printer is powered off	Set parameter will not be retained	
	Validity in a job	Becomes invalid after execution	
	Validity after a job	Becomes invalid after the job	

[Function]

Downloads PCX File (typically created on Windows Paint brush) to the internal graphics image memory to print.

[Format]

<GP>aaaaa,n~n

●Parameter

a           Quantity of bytes to download  
n           Graphic data

[Coding Example]

```
<A>
<V>50<H>50<GP>04500,XXXXXXXXXXXX
<Q>2
<Z>
```

[Notes]

1. The data is transmitted in binary (8bit/1font data). Actual size of PCX file is the value to parameter "a".
2. PCX file consists of the header part (the first 128 byte) and compressed graphic data.
3. If the total quantity of bytes of a PCX file is not consistent with actual data being sent, it may result in an operation failure.
4. The total quantity of byte is displayed in the property of the file.
5. PCX file can be used only in black/white mode. A PCX file in color mode will result in a command error and no printing.  
The command does not support compressed type of the PCX file. Make sure that file extension is PCX before printing.
6. Rotation<%>, Expansion<L> can be used in combination with this command.

## 12 System Command

12.1 System			
Available for	CT400/410/420	CT400-2/410-2/420-2	CT408i/412i/424i
<b>Print speed</b>		<b>ESC+CS</b>	
Hexadecimal code	ESC <1B> <sub>16</sub>	CS <43> <sub>16</sub> <53> <sub>16</sub>	Parameter a
Initial value	See table below		
Persistence of the command	When printer is powered off	Set parameter will not be retained	
	Validity in a job	Retained until next valid setting	
	Validity after a job	Retained until next valid setting	

### [Function]

Specifies print speed.

### [Format]

<CS>a

#### ●Parameter

a = see table below.

### [Coding Example]

<A>

**<CS>3**

<Z>

### [Note]

- The setting by this command will not persist after power-down of the printer. When repowered, either the printer' default value, or original values set by the command <PG> will be valid.

### [Tips]

- Invalid range being selected will result in a command error and the setting will not be changed.
- Value can be reset to the printer's Initial value by default-setting.

### [Parameter initial value and valid range]

Model	Initial value	Parameter selection	Valid	Parameter values supporting print speed
CT400	4	2,3,4,5,6		2 : 2ips (50mm/sec)
CT410	4	2,3,4		3 : 3ips (75mm/sec)
CT420	2	2,3		4 : 4ips (100mm/sec)
CT400-2	4	2,3,4,5,6		5 : 5ips (125mm/sec)
CT410-2	4	2,3,4		6 : 6ips (150mm/sec)
CT420-2	2	2,3		
CT408i	4	2,3,4,5,6		
CT412i	4	2,3,4		
CT424i	2	2,3		

12.2 System			
Available for	CT400/410/420	CT400-2/410-2/420-2	CT408i/412i/424i
<b>Print darkness</b>		<b>ESC+#E</b>	
Hexadecimal code	ESC <1B> <sub>16</sub>	#E <23> <sub>16</sub> <45> <sub>16</sub>	Parameter a(b)
Initial value	See table below		
Persistence of the command	When printer is powered off	Set parameter will not be retained	
	Validity in a job	Retained until next valid setting	
	Validity after a job	Retained until next valid setting	

[Function]

Specifies print darkness.

[Format]

<#E>a(b)

•Parameter

a Print darkness level = See table below.

b Print darkness = A to F (omissible)

Use "A" (CT400/410TT, CT400-2/410-2TT, CT408iTT/CT412iTT: default is "B") in normal work environment.

The parameter "b" (A to F) is to optimize the darkness for different media types.

[Coding Example]

<A>

<#E>3

<Z>

[Note]

1. The setting by this command will not persist after power-down of the printer. When repowered, either the printer's default value or the value set by the command <PG> will become valid.

[Tips]

1. Invalid range being selected will result in a command error and the setting will not be changed.
2. Value can be reset to the printer's Initial value by default-setting.

[Parameter [a]: Initial value and valid range]

Model	Initial value	Parameter
CT400/410/420DT/TT	3: Normal	1: Light
CT400-2/410-2/420-2DT/TT		2: Slightly light
CT408i/412iDT/TT	3: Normal	3: Normal
CT424iDT/TT		4: Slightly dark
		5: Dark

12.3 System				
Available for	CT400/410/420		CT400-2/410-2/420-2	CT408/412/424i
	<b>Label size</b>			<b>ESC+A1</b>
Hexadecimal code	ESC	A1	Parameter	
	<1B> <sub>16</sub>	<41> <sub>16</sub> <31> <sub>16</sub>	aaaabbbb	
Initial value	None			
Persistence of the command	When printer is powered off		Set parameter will not be retained	
	Validity in a job		Retained until next valid setting	
	Validity after a job		Retained until next valid setting	

[Function]

Specifies label size.

[Format]

<A1>aaaabbbb

•Parameter

a Label height = see table in next page  
 b Label width = see table in next page

[Coding Example]

<A>

<A1>08000640

<Z>

[Notes]

1. This command is useful when you use a label in a smaller size than the print head width, and need to optimize the base reference point accordingly.
2. Include backing paper's measurements when you specify the label size.

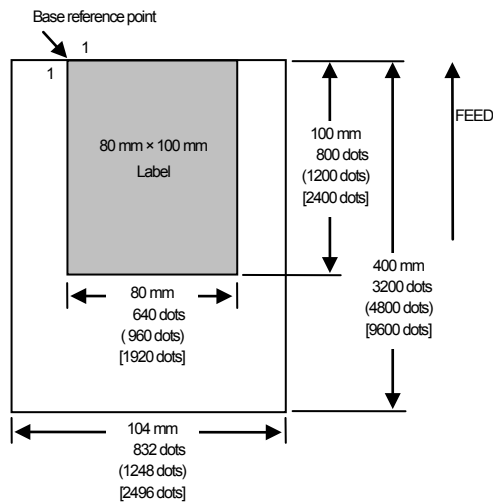

Value ( ) 12 dots/mm  
 Value [ ] 23.6 dots/mm

[Valid range]

Model	Label width (dot)	Label height (dot)
CT400DT/TT	1 - 832	1 - 3200
CT410DT/TT	1 - 1248	1 - 4800
CT420DT/TT	1 - 2496	1 - 9600
CT400-2DT/TT	1 - 832	1 - 3200
CT410-2DT/TT	1 - 1248	1 - 4800
CT420-2DT/TT	1 - 2496	1 - 9600
CT408iDT/TT	1 - 832	1 - 3200
CT412iDT/TT	1 - 1248	1 - 4800
CT424iDT/TT	1 - 2496	1 - 9600



12.4 System			
Available for	CT400/410/420	CT400-2/410-2/420-2	CT408i/412i/424i
<b>Base Reference Point</b>		<b>ESC+A3</b>	
Hexadecimal code	ESC <1B> <sub>16</sub>	A3 <41> <sub>16</sub> <33> <sub>16</sub>	Parameter VabbbbHcdddd
Initial value	None		
Persistence of the command	When printer is powered off	Set parameter will not be retained	
	Validity in a job	Retained until next valid setting	
	Validity after a job	Retained until next valid setting	

[Function]

Specifies a new base reference point position for the current label.

[Format]

<A3>VabbbbHcdddd

•Parameter

- a Plus/Minus character (omissible) for vertical position correction = +, -
- b Vertical position shift (dot) = see table in next page
- c Plus/Minus character (omissible) for horizontal position correction = +, -
- d Horizontal position shift (dot) = see table in next page

[Coding Example]

<A>  
<A3>V10H10  
 <Z>

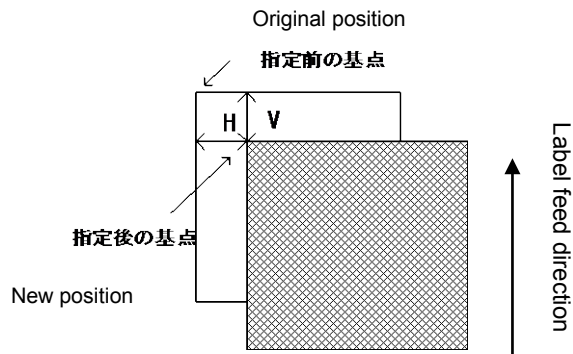

[Notes]

1. The new position inadvertently set outside printable area, will result in no printing.
2. The new position will be applied to all the label formats. Pay attention to it when you run multiple formats.

[Tips]

1. The setting by this command <A3> is not persistent after power-down of the printer.

[Valid range for different models]

Model	Horizontal position shift (dot)	Vertical position shift (dot)
CT400DT/TT	1 - 832	1 - 3200
CT410DT/TT	1 - 1248	1 - 4800
CT420DT/TT	1 - 2496	1 - 9600
CT400-2DT/TT	1 - 832	1 - 3200
CT410-2DT/TT	1 - 1248	1 - 4800
CT420-2DT/TT	1 - 2496	1 - 9600
CT408iDT/TT	1 - 832	1 - 3200
CT412iDT/TT	1 - 1248	1 - 4800
CT424iDT/TT	1 - 2496	1 - 9600

12.5 System			
Available for	CT400/410/420	CT400-2/410-2/420-2	CT408i/412i/424i
<b>Print end position</b>		<b>ESC+EP</b>	
Hexadecimal code	ESC <1B> <sub>16</sub>	EP <45> <sub>16</sub> <50> <sub>16</sub>	Parameter None
Initial value	None		
Persistence of the command	When printer is powered off	Set Parameter will not be retained	
	Validity in a job	Becomes invalid after execution	
	Validity after a job	Becomes invalid after the job	

[Function]

Specifies the label stop position in the sensor-disabled mode.

[Format]

<EP>

[Coding Example]

```

<A>
<A1>14240832
<Z>
<A>
<V>100<H>200<P>2<L>0202<OA>ABCD
<Q>2
<EP>
<Z>

```

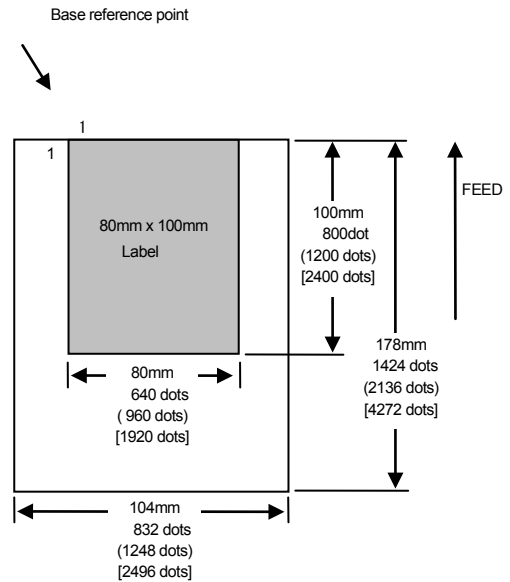
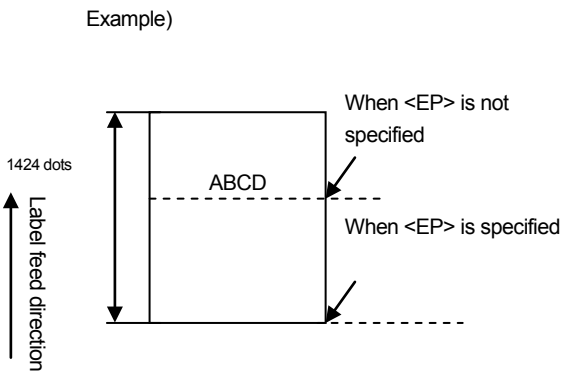

Value ( ) 12 dots/mm  
Value [ ] 23.6 dots/mm

[Notes]

1. This command is valid when sensor is disabled.
2. Use this command in combination with size setting command <A1>.

12.6 System			
Available for	CT400/410/420	CT400-2/410-2/420-2	CT408i/412i/424i
<b>Multiple cut</b>		ESC+ ( (NULL)	
Hexadecimal code	ESC <1B>16	( (NULL) <7E>16 (<00>16)	Parameter aaaa
Initial value	aaaa=1		

Persistence of the command	When printer is powered off	Set Parameter will not be retained
	Validity in a job	Set Parameter will be retained until next valid setting
	Validity after a job	Set Parameter will be an initial value for the subsequent job

[Function]

Specifies the number of labels to print between each cut.

Quantity of labels printed is equal to the product of the quantity specified x the value of aaaa.

[Format]

<~(NULL)>aaaa

•Parameter

a      Number of labels to print between each cut      = Qty range : 0 to 9999

[Coding Example]

```
<A>
<V>100<H>200<P>2<L>0202<OA>ABC
<Q>4
<->2
<Z>
```

(1) Normal (complete) cut

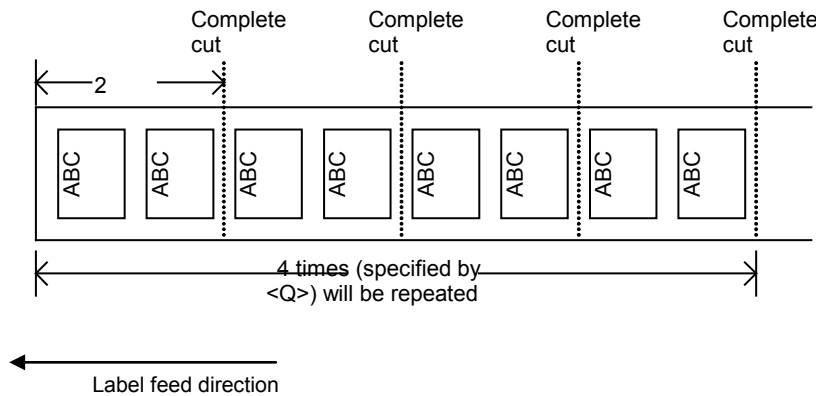

(2) Partial cut compatible mode (For CT400i(Type1/Type2) only)

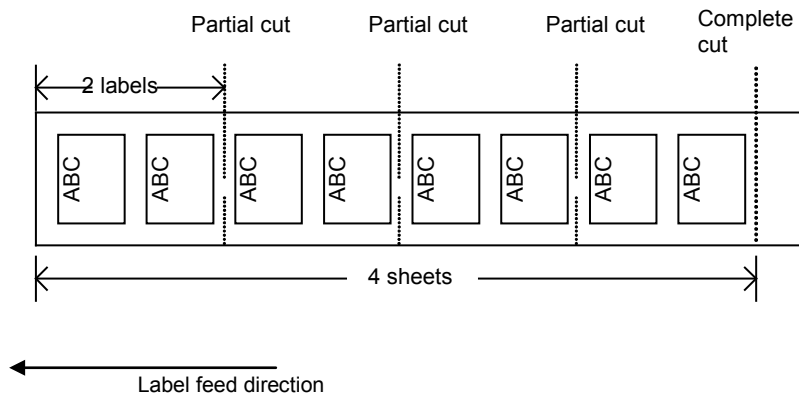

[Notes]

1. Valid only for cutter-mounted models.
2. If the parameter is not specified by this command < ~>, each label will be cut after being printed.
3. In case the parameter "a" is set to 0, no label will be cut.
4. The product of Qty and value "aaaa" shall not exceed the maximum number 999999.
5. Use the command <~> directly after Qty<Q>. Qty<Q>, in this case, is to specify sets of printing repeated in specified cut cycle.
6. This command may be used in neither combination with other cut commands ; <CT>, <-A>.
7. Except CT400i(Type1/Type2) , there is no selection of complete or partial cut is available (complete cut only).
8. Set DIP SW 1,2,3 to ON for partial cut operation mode on CT400i(Type1/Type2).
9. The last label, even when partial cut operation mode is active, will be cut completely.  
In case the parameter "a" is set to 0, no label will be cut.

12.7 System			
Available for	CT400/410/420	CT400-2/410-2/420-2	CT400/412/424
<b>Cutting interval of label</b>		<b>ESC+CT</b>	
Hexadecimal code	ESC <1B> <sub>16</sub>	CT <43> <sub>16</sub> <54> <sub>16</sub>	Parameter aaaa
Initial value	aaaa=1		
Persistence of the command	When printer is powered off	Set Parameter will not be retained.	
	Validity in a job	Retained until next valid setting.	
	Validity after a job	Set Parameter will be an initial value for the subsequent job.	

[Function]

Cuts labels at a specified interval in a print job.

[Format]

<CT>aaaa

●Parameter

a      Number of labels between each cut    = Qty range : 0 to 9999

[Coding Example]

<A>

<V>100<H>200<P>2<L>0202<X22>,ABC

**<CT>2**

<Q>7

<Z>

(1) Normal (complete) cut

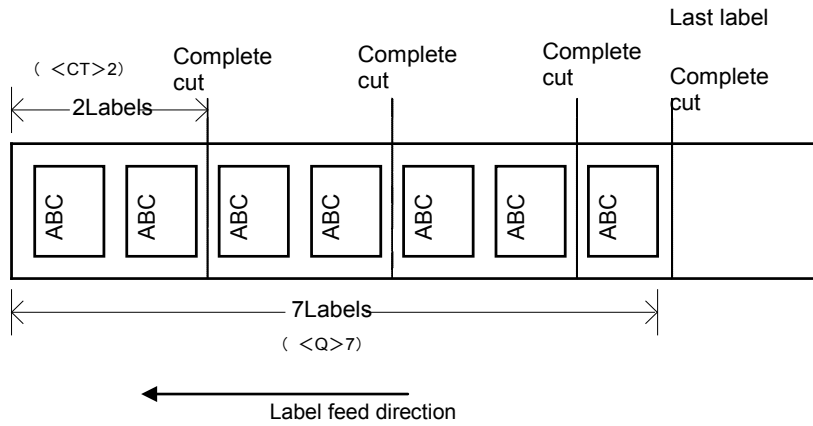

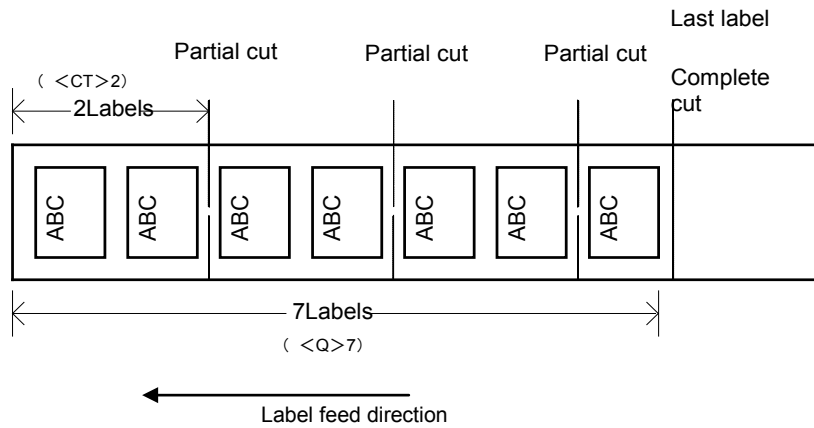

[Notes]

1. Valid only for cutter-mounted models.
2. If the parameter is not specified by this command <CT>, each label will be cut after being printed.
3. In case the parameter "a" is set to 0, no label will be cut.
4. Place this command directly before <Q>.
5. This command may not be used in combination with other cut command <~>.
6. There is no selection of complete or partial cut is available (complete cut only).
7. The last label, even when partial cut operation mode is active, will be cut completely.  
In case the parameter "a" is set to 0, no label will be cut.

12.8 System			
Available for	CT400/416/420	CT400-Z/416-Z/420-2	CT408/412/424
<b>Cutting last label</b>			<b>ESC+NC</b>
Hexadecimal code	ESC <1B> <sub>16</sub>	NC <4E> <sub>16</sub> <43> <sub>16</sub>	Parameter NIL
Initial value	NIL		
Persistence of the command	When printer is powered off	Will not be retained	
	Validity in a job	Becomes invalid after execution	
	Validity after a job	Becomes invalid after the job	

[Function]

Cuts any printed labels that remain in the printer.

[Format]

<NC>

[Coding Example]

<A>  
<NC>  
 <Z>

- (1) Label stop position  
 A: Printed  
 B: Not printed  
 C: Not printed  
 D: Not printed
- (2) Command received
- (3) Label is fed to the cut position.
- (4) Label is cut off.
- (5) Label is back fed to the head position.

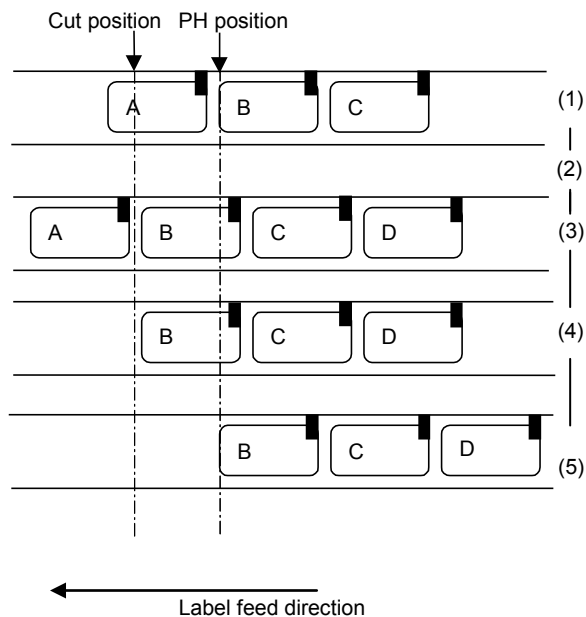

[Notes]

1. Valid only for cutter-mounted models.
2. This command is to cut the last label remaining in the printer.
3. Place this command <~B> between <A>Start code and <Z>Stop code.
4. This command < NC> may not be used in combination with other commands.
5. This command < NC> is valid when the printer still holds the label which is not cut after being printed.

[Tips]

1. This command is useful to cut remaining label in printer after the commands <~A>0, <~>0 are executed.

12.9 System				
Available for	CT400/410/420	CT400-2/410-2/420-2	CT408i/412i/424i	
<b>Cutting interval of label</b>			<b>ESC+~A</b>	
Hexadecimal code	ESC <1B>16	~A <7E>16<41>16	Parameter aaaa	
Initial value	aaaa=1			
Persistence of the command	When printer is powered off	Set parameter will not be retained		
	Validity in a job	Retained until next valid setting		
	Validity after a job	Set Parameter will be an initial value for the subsequent job		

[Function]

Cuts labels at a specified interval in a print job.

[Format]

<~A>aaaa

●Parameter

a          Number of labels between each cut    = Qty range : 0 to 9999

[Coding Example]

<A>

<V>100<H>200<P>2<L>0202<XM>ABC

<~A>2

<Q>7

<Z>

(1) Normal (complete) cut

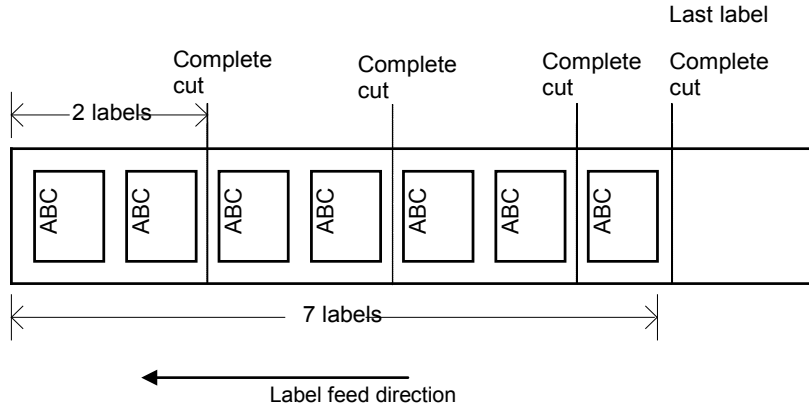



(2) Partial cut compatible mode (For CT400i (Type1/Type2) only)

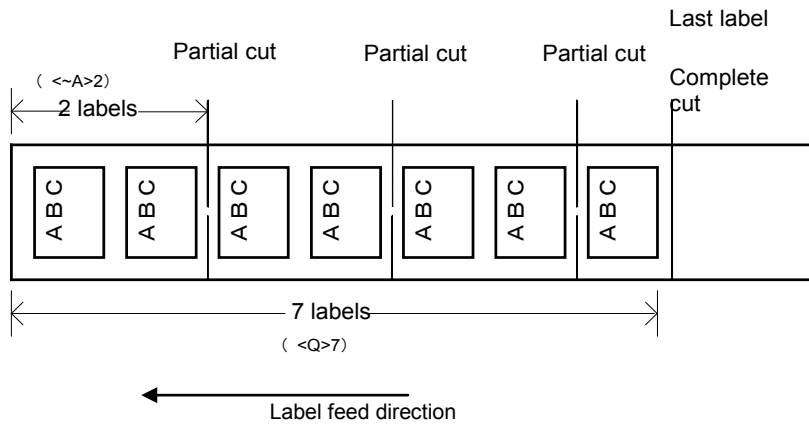

[Notes]

1. Valid only for cutter-mounted models.
2. If the parameter is not specified by this command <~A>, each label will be cut after being printed.
3. In case the parameter "a" is set to 0, no label will be cut.
4. Place this command directly before <Q>.
5. This command may not be used in combination with other cut command <~>.
6. Except CT400i (Type1/Type2), there is no selection of complete or partial cut is available (complete cut only).
7. Set DIP SW 1, 2, 3 to ON for partial cut operation mode on CT400i (Type1/Type2).
8. The last label, even when partial cut operation mode is active, will be cut completely.  
In case the parameter "a" is set to 0, no label will be cut.

12.10 System			
Available for	CT400/410/420	CT400-2/410-2/420-2	CT408i/412i/424i
<b>Cutting last label</b>		<b>ESC+~B</b>	
Hexadecimal code	ESC <1B>16	~B <7E>16<42>16	Parameter NIL
Initial value	NIL		
Persistence of the command	When printer is powered off	Will not be retained.	
	Validity in a job	Becomes invalid after execution	
	Validity after a job	Becomes invalid after the job	

[Function]

[Format]

<~B>

[Coding Example]

<A>

**<~B>**

<Z>

(1) Label stop position

- A: Printed
- B: Not printed
- C: Not printed
- D: Not printed

(2) Command received

(3) Label is fed to the cut position.

(4) Label is cut off.

(5) Label is back fed to the print position.

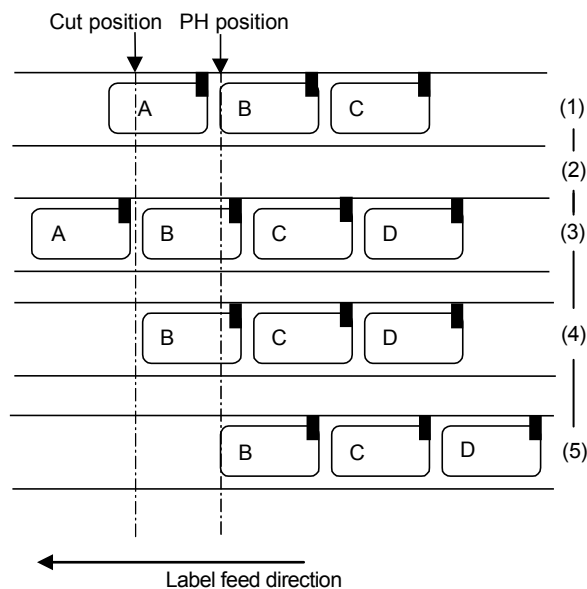

[Notes]

1. Valid only for cutter-mounted models.
2. This command is to cut the last label remaining in the printer, when the printer is in stop mode without cutting after printing.
3. Place this command <~B> between <A>Start code and <Z>Stop code.
4. This command <~B> may not be used in combination with other commands.
5. This command <~B> is valid when the printer still holds the label which is not cut after being printed.

[Tips]

1. This command is useful to cut remaining label in printer after the commands <~A>0, <~>0 are executed.
2. In case DIP SW1, 2, 3 are set to ON for compatibility mode for partial cut, the label will be completely cut by this command. (For CT400i (Type1/Type2) only)

12.11 System			
Available for	CT400/410/420	CT400-2/410-2/420-2	CT408i/412i/424i
<b>Clear memory</b>		<b>ESC+*</b>	
Hexadecimal code	ESC <1B> <sub>16</sub>	* <2A> <sub>16</sub>	Parameter a
Initial value	NIL		
Persistence of the command	When printer is powered off	Set Parameter will not be retained	
	Validity in a job	Becomes invalid after execution	
	Validity after a job	Becomes invalid after the job	

[Function]

Clears print jobs and specific item in memory

[Format]

<\*>a

•Parameter

a	Item to clear	=	Not specified	:	Single item buffer, Edit buffer (reprint is not possible)
			T	:	Multi item buffer, Edit buffer (Clears job which is in parsing)
			&	:	User defined characters
			X	:	Form overlay
			X	:	All clear

(Receive buffer, Edit buffer, User defined characters, form overlay)  
Note the job ,which is currently in progress, will not be cleared

[Coding Example1] Clear receive+Edit buffer

<A>  
<\*>  
<Z>

[Coding Example2] All clear

<A>  
<\*>X  
<Z>

[Coding Example3] Clear user-defined characters

<A>  
<\*>T  
<Z>

[Notes]

1. Place this command between <A>Start code and <Z>Stop code.
2. Sending <\*>(a=X) will clear all the data preceding the command. However, the data which is completely parsed before the command will not be cleared. X will clear user-defined characters and form overlay.

[Tips]

1. After the command <\*> is executed, have an interval of more than 100ms before sending next print data.
2. The job in printing will not be terminated by the command <\*>.

<b>12.12 System</b>			
Available for	CT400/410/420	CT400-2/410-2/420-2	CT408i/412i/424i
<b>Set printer offline</b>		<b>ESC+@</b>	
Hexadecimal code	ESC <1B> <sub>16</sub>	@ <40> <sub>16</sub>	Parameter NIL
Initial value	NIL		
Persistence of the command	When printer is powered off	Set Parameter will not be retained	
	Validity in a job	Becomes invalid after execution	
	Validity after a job	Becomes invalid after the job	

[Function]

Set printer offline

[Format]

<@>

[Coding Example]

<A>

<@>

<Z>

[Notes]

1. Place this command between <A>Start code and <Z>Stop code
2. Select single-item-buffer for data transmission mode

12.13 System			
Available for	CT400/410/420	CT400-2/410-2/420-2	CT408i/412i/424i
<b>Reprint</b>		<b>ESC+C</b>	
Hexadecimal code	ESC <1B> <sub>16</sub>	C <43> <sub>16</sub>	Parameter NIL
Initial value	NIL		
Persistence of the command	When printer is powered off	Will not persist after power-down	
	Validity in a job	Becomes invalid after execution	
	Validity after a job	Becomes invalid after the job	

[Function]

Specifies to reprint the last label

[Format]

<C>

[Coding Example]

<A>

**<C>**

<Z>

[Note]

1. The last print data will not persist after the power-down. The command will not produce reprint after the printers repowered.
2. As the UID reading from RFID tag does not function properly, reprint of UID printing command <TU> cannot be executed.

[Tips]

1. In case the print data contains sequential numbering by command <F>, the same number will be printed.

12.14 System			
Available for	CT400/410/420	CT400-2/410-2/420-2	CT408/412/424i
<b>Registers printer settings in EEPROM</b>		<b>ESC+PG</b>	
Hexadecimal code	ESC <1B> <sub>16</sub>	PG <50> <sub>16</sub> <47> <sub>16</sub>	Parameter abcdefghijklmnopqrrstuvwxyz
Initial value	See table in next page		
Persistence of the command	When printer is powered off	Set Parameter will be retained	
	Validity in a job	Retained until next valid setting	
	Validity after a job	Retained until next valid setting	

[Function]

Registers printer settings in EEPROM

[Format]

<PG>abcdefghijklmnopqrrstuvwxyz

•Parameter

See table in next page for parameter details.

[Coding Example]

<A>

**<PG><00 00 02 00 00 00 00 41 01 00 00 00 00 00 00 0C 80 03 40 00 00 00 00 00 00 00 00 00><sub>16</sub>**

<Z>

Parameters shall be given in Hex value <00><sub>16</sub><00><sub>16</sub><02><sub>16</sub>.....<00><sub>16</sub>

[Notes]

1. The settings by this command <PG> is not necessary unless specifically required.
2. The settings done by the command <PC> will persist after power-down of printer.

No	Item	Valid selection						
a	Reserved	00H Fixed						
b	Reserved	00H Fixed						
c	Print speed 203dpi Initial value: 02H 305dpi Initial value: 02H 600dpi Initial value: 00H	00H 2ips 01H 3ips 02H 4ips (CT400/410/400-2/410-2/408i/412i only) 03H 5ips (CT400/400-2/408i only) 04H 6ips (CT400/400-2/408i only)						
d	Reserved	00H Fixed						
e	Cutter/Partial Cut operation	00H Back feed after print 01H Back feed before print 02H No back feed						
f	Dispenser operation	00H Back feed after print 01H Back feed before print						
g	Linerless media	00H Back feed before print 01H No back feed						
h	Print darkness <table border="1" style="width: 100%; border-collapse: collapse;"> <tr> <td style="width: 60%;">CT400/410DT CT400-2/410-2DT CT408i/412iDT</td> <td style="width: 40%;">Initial value : A</td> </tr> <tr> <td>CT400/410TT CT400-2/410-2TT CT408i/412iTT</td> <td>Initial value : B</td> </tr> <tr> <td>CT420DT/TT CT420-2DT/TT CT424iDT/TT</td> <td>Initial value : A</td> </tr> </table>	CT400/410DT CT400-2/410-2DT CT408i/412iDT	Initial value : A	CT400/410TT CT400-2/410-2TT CT408i/412iTT	Initial value : B	CT420DT/TT CT420-2DT/TT CT424iDT/TT	Initial value : A	41H A 42H B 43H C 44H D 45H E 46H F
CT400/410DT CT400-2/410-2DT CT408i/412iDT	Initial value : A							
CT400/410TT CT400-2/410-2TT CT408i/412iTT	Initial value : B							
CT420DT/TT CT420-2DT/TT CT424iDT/TT	Initial value : A							
h	Print darkness level (Initial value: 03H)	01H Darkness1 02H Darkness2 03H Darkness3 04H Darkness4 05H Darkness5						
i	Sensory type (Initial value: 01H)	00H Reflective 01H Transmissive 02H Disabled						
j	0 slash (Initial value: 01H)	00H Disabled 01H Enabled						
k	Kanji code (Initial value: 00H)	00H JIS code 01H Shift JIS code						
l	Media type (Initial value: 00H)	00H Self-adhesive 01H Non-adhesive						
m	Initial feed (Initial value: 00H)	00H Disabled 01H Enabled						
n	Character pitch (Initial value: 01H)	00H Fixed 01H Proportional						
o	Label height (dot)	<table border="1" style="width: 100%; border-collapse: collapse;"> <tr> <td style="width: 30%;">CT400 CT400-2 CT408i</td> <td style="width: 70%;">[01H - C80H] (1 to 3200)</td> </tr> <tr> <td>CT410 CT410-2 CT412i</td> <td>[01H - 12C0H] (1 to 4800)</td> </tr> <tr> <td>CT420 CT420-2 CT424i</td> <td>[01H - 2580H] (1 to 9600)</td> </tr> </table>	CT400 CT400-2 CT408i	[01H - C80H] (1 to 3200)	CT410 CT410-2 CT412i	[01H - 12C0H] (1 to 4800)	CT420 CT420-2 CT424i	[01H - 2580H] (1 to 9600)
CT400 CT400-2 CT408i	[01H - C80H] (1 to 3200)							
CT410 CT410-2 CT412i	[01H - 12C0H] (1 to 4800)							
CT420 CT420-2 CT424i	[01H - 2580H] (1 to 9600)							
p	Label width (dot)	<table border="1" style="width: 100%; border-collapse: collapse;"> <tr> <td style="width: 30%;">CT400 CT400-2 CT408i</td> <td style="width: 70%;">[01H - 340H] (1 to 832)</td> </tr> <tr> <td>CT410 CT410-2 CT412i</td> <td>[01H - 4E0H] (1 to 1248)</td> </tr> <tr> <td>CT420 CT420-2 CT424i</td> <td>[01H - 9C0H] (1 to 2496)</td> </tr> </table>	CT400 CT400-2 CT408i	[01H - 340H] (1 to 832)	CT410 CT410-2 CT412i	[01H - 4E0H] (1 to 1248)	CT420 CT420-2 CT424i	[01H - 9C0H] (1 to 2496)
CT400 CT400-2 CT408i	[01H - 340H] (1 to 832)							
CT410 CT410-2 CT412i	[01H - 4E0H] (1 to 1248)							
CT420 CT420-2 CT424i	[01H - 9C0H] (1 to 2496)							

(- continued)

No	Item	Valid selection
q	Vertical start point correction (dot)	[00H - 318H] (0 to 792) [FFFFH - FCE8H] (-1 to -792)
r	Horizontal start point correction (dot)	[00H - 318H] (0 to 792) [FFFFH - FCE8H] (-1 to -792)
s	Vertical pitch offset (dot)	[00H - 63H] (0 to 99) [FFH - 9DH] (-1 to -99)
t	TearOff position offset (dot)	[00H - 63H] (0 to 99) [FFH - 9DH] (-1 to -99)
u	Cut position offset (dot)	[00H - 63H] (0 to 99) [FFH - 9DH] (-1 to -99)
v	Dispensing position offset (dot)	[00H - 63H] (0 to 99) [FFH - 9DH] (-1 to -99)
w	Control code	00H Standard 01H Non-standard
x	Inter-label gap (dot) 203dpi Initial value : 18H 305dpi Initial value : 24H 600dpi Initial value : 48H	[08H - 40H] (8 to 64) 203dpi [0CH - 60H] (12 to 96) 305dpi [18H - C0H] (24 to 192) 600dpi
y	Buzzer (Initial value : 00H)	00H Enable 01H Disable
z	Priority assignment RS232C (Initial value : 01H)	00H DSW priority 01H Command priority



12.15 System			
Available for	CT400/410/420	CT400-2/410-2/420-2	CT408/412/424i
<b>Registers printer settings in EEPROM</b>		<b>ESC+PC</b>	
Hexadecimal code	ESC <1B> <sub>16</sub>	PC <50> <sub>16</sub> <43> <sub>16</sub>	Parameter 1)「a, b, c, d, ...y, z, a1」,2)「aa, b」
Initial value	See next page		
Persistence of the command	When printer is powered off	Set Parameter will be retained	
	Validity in a job	Retained until next valid setting	
	Validity after a job	Retained until next valid setting	

[Function]

Registers printer settings in EEPROM

[Format1] When all settings are newly registered

<PC>a,b,c,d,e,f,g,h,i,1,2,j,k,l,m,n,o,pppp,qqqq,rr,ssss,t,u,v,w,x,y,z,a1

•Parameter

a Item No. = F : All  
 b . . . a1 Setting details = See table in next page for individual Parameters

[Format2] When specific item are needed to be registered

<PC>aa,b

•Parameter

a Item No. = 1 - 27  
 b Setting details = See table in next page for individual Parameters

[Coding Example1] all settings

<A>  
<PC>F,,2,,,,A4,,1.0,,1,1,3000,2400,,,,,1  
 <Z>

[Coding Example2] specific item

<A>  
<PC>26.1  
 <Z>

[Notes]

1. The settings done by the command <PC> will persist after power-down of printer.
2. The entire or partial parameter entities is omissible by using commas.  
 Current valid setting will be applied to comma ",," position.

ItemNo	Item	Function	Valid selection						
b	1	Reserved	0 Fixed						
c	2	Reserved	0 Fixed						
d	3	Print speed 203dpi Initial value : 02H 305dpi Initial value : 02H 600dpi Initial value : 00H	0 2ips 1 3ips 2 4ips(CT400/410/400-2/410-2/408i/412i only) 3 5ips(CT400/400-2/408i only) 4 6ips(CT400/400-2/408i only)						
e	4	Reserved	0 Fixed						
f	5	Cutter/Partial cut operation	0 Cutter operation 1 (head position) 1 Cutter operation 2 (cutter position) 2 Cutter operation 3 (no backfeed) The parameters below is only valid for CT400(type1/2) 3 Cutter operation 4 (cutter position + cut during printing) 4 Invalid (reserved) 5 Cutter operation 1 (head position) 6 Cutter operation 2 (cutter position) 7 Cutter operation 3 (no backfeed) 8 Cutter operation 4 (cutter position + cut during printing)						
g	6	Dispenser operation	0 Operation 1 (head position) 1 Operation 2 (dispenser position)						
h	7	Linerless	0 Operation 2 (cutter position) 1 Operation 3 (no backfeed)						
i1	8	Print darkness <table border="1" style="width: 100%; border-collapse: collapse;"> <tr> <td>CT400/410DT CT400-2/410-2DT CT408i/412iDT</td> <td>Initial value: A</td> </tr> <tr> <td>CT400/410TT CT400-2/410-2TT CT408i/412iTT</td> <td>Initial value: B</td> </tr> <tr> <td>CT420DT/TT CT420-2DT/TT CT424iDT/TT</td> <td>Initial value: A</td> </tr> </table>	CT400/410DT CT400-2/410-2DT CT408i/412iDT	Initial value: A	CT400/410TT CT400-2/410-2TT CT408i/412iTT	Initial value: B	CT420DT/TT CT420-2DT/TT CT424iDT/TT	Initial value: A	A B C D E F
CT400/410DT CT400-2/410-2DT CT408i/412iDT	Initial value: A								
CT400/410TT CT400-2/410-2TT CT408i/412iTT	Initial value: B								
CT420DT/TT CT420-2DT/TT CT424iDT/TT	Initial value: A								
i2	9	Print darkness level (Initial value: 3)	1 Darkness 1 2 Darkness 2 3 Darkness 3 4 Darkness 4 5 Darkness 5						
j	10	Sensor type (Initial value: 1)	0 Reflective 1 Transmissive 2 Disabled						
k	11	0 slash (Initial value: 1)	0 Disabled 1 Enabled						
l	12	Kanji code (Initial value: 0)	0 JIS Code 1 Shift JIS Code						
m	13	Media type (Initial value: 0)	0 Self-adhesive 1 non-adhesive						
n	14	Initial feed (Initial value: 0)	0 Disabled 1 Enabled						
o	15	Character pitch (Initial value: 1)	0 Fixed 1 Proportional						
p	16	Label Height (dot)	CT400 CT400-2 CT408i 1 to 3200 CT410 CT410-2 CT412i 1 to 4800 CT420 CT420-2 CT424i 1 to 9600						
q	17	Label width (dot)	CT400 CT400-2 CT408i 1 to 832 CT410 CT410-2 CT412i 1 to 1248 CT420 CT420-2 CT424i 1 to 2496						
r	18	Vertical start point correction (dot)	-792 to 792						
s	19	Horizontal start point correction (dot)	-792 to 792						
t	20	Vertical pitch offset (dot)	-99 to 99						
u	21	TearOff position offset (dot)	-99 to 99						
v	22	Cut position offset (dot)	-99 to 99						

Partial cut operation 4  
(cutter position + cut during printing)

Partial cut operation 3  
(no backfeed)

w	23	Dispensing position offset (dot)	-99 to 99
x	24	Control code	0 Standard 1 Non-standard
y	25	Inter-label gap (dot) 203dpi Initial value: 24 305dpi Initial value: 36 600dpi Initial value: 72	8 to 64 203dpi 12 to 96 305dpi 24 to 192 600dpi
z	26	Buzzer (Initial value: 0)	0 Enable 1 Disable
a1	27	Priority assignment RS232C interface (Initial value: 1)	0 DSW priority 1 Command priority

12.16 System			
Available for	CT400/410/420	CT400-2/410-2/420-2	CT408/412/424i
<b>Auto-CR line spacing</b>		<b>ESC+E</b>	
Hexadecimal code	ESC <1B> <sub>16</sub>	E <45> <sub>16</sub>	Parameter aaa
Initial value	aaa=0		
Persistence of the command	When printer is powered off	Set Parameter will not be retained	
	Validity in a job	Becomes invalid after execution	
	Validity after a job	Becomes invalid after the job	

[Function]

Specifies amount of line spacing and CR

[Format]

<E>aaa

•Parameter

a line spacing = valid range : 0 to 999 dots

[Coding Example]

<A>

**<E>10**

<V>100<H>200<P>2<L>0304<OA>ABCDE+CR

FGHIJ+CR

<Q>2

<Z>

[Notes]

1. Put "CR(0DH)" where the CR needs to be executed in specified line spacing by this command.
2. Rotation command <%> can be used in combination with this command.
3. The command <E> may be used in multiple times in a job and change the line spacing as necessary.
4. The command will execute auto CR in the specified line spacing. Horizontal print position shall be specified by the command <H> to directly after the vertical print position is thus (by specified line spacing) specified.  
In case different horizontal positions are specified by the command <H> in multiple times, the last specified position will remain valid for Further CR(0DH) to follow.

12.17 System				
Available for	CT400/410/420	CT400-2/410-2/420-2	CT408/412/424i	
<b>User download</b>			<b>ESC+LD</b>	
Hexadecimal code	ESC <1B> <sub>16</sub>	LD <4C> <sub>16</sub> <44> <sub>16</sub>	Parameter , a, b, c, d, e, f, g, h, i, j	
Initial value	See table below			
Persistence of the command	When printer is powered off		Set Parameter will be retained	
	Validity in a job		Retained until next valid setting	
	Validity after a job		Retained until next valid setting	

[Function]

Settings of : Auto-online, zero slash(Enable/Disable), protocol code, Eurocode

[Format]

<LD>,a,b,c,d,e,f,g,h,i,j

- Parameter

Function	Parameter	Description	Default	
			Standard	Non-standard
Protocol code	a(HEX)	STX	02H	{(7BH)
	b(HEX)	ETX	03H	}(7DH)
	c(HEX)	ESC	1BH	^(5EH)
	d(HEX)	ENQ	05H	@(40H)
	e(HEX)	CAN	18H	!(21H)
	f(HEX)	NULL	00H	-(7EH)
	g(HEX)	Offline		@(40H)
Auto-online	h(ASCII)	0: YES 1: NO	0(30H)	0(30H)
Zero slash	i(ASCII)	0: YES 1: NO	0(30H)	0(30H)
Euro code	j(HE)	D5H	D5H	D5H

[Coding Example]

```
<A>
<LD>,{,},%,&,. - ,0,0,<FF>16
<Z>
```

[Notes]

1. Place this command between <A>Start code and <Z> Stop code.
2. The command <LD> may be received while printer is in online mode.
3. Certain parameters may be omitted by giving “,” as place holder. Current valid setting will be applied to “,” position.
4. In case more than 9 comma“,” is used, or specified code is used in other commands or in print data, the result may not be guaranteed.
5. After the setting by this command <LD> is successfully completed, valid settings are printed.  
After printing is completed, press the Feed key once and repower the printer to make the new settings valid. Failure to pressing the Feed key will result in the settings not being properly saved.

12.18 System			
Available for	CT400/410	CT400-2/410-2	CT408/412i
			CT420/CT420-2/CT424i
<b>2-color printing area</b>		<b>ESC+2S</b>	
Hexadecimal code	ESC	2S	Parameter
	<1B> <sub>16</sub>	<32> <sub>16</sub> <53> <sub>16</sub>	aVbbbbYcccc
Initial value	a=0,bbbb=1,cccc=1		
Persistence of the command	When printer is powered off	Set parameter will not be retained	
	Validity in a job	Becomes invalid after execution	
	Validity after a job	Becomes invalid after the job	

[Function]

Specifies dual-color printing area

[Format]

<2S>aVbbbbYcccc

• Parameter

a	Print Head block	=	0	:	Left
			1	:	Right
			2	:	Whole
b	Start position (Vertical)	=	1 ~ total label length (dots)		
c	End position (Vertical)	=	1 ~ total label length (dots)		

[Coding Example]

```
<A>
<A1>08000832
<V>100<H>200<P>2<L>0304<OA>ABCD
<2S>2V0001Y0600
<Q>2
<Z>
```

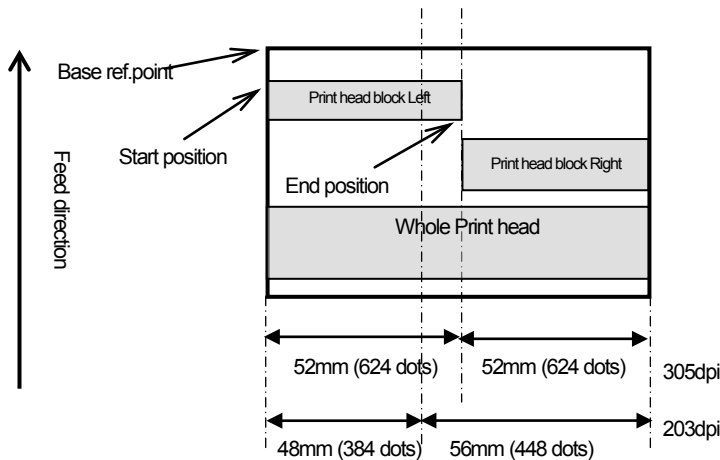

[Notes]

1. Specify label size by command <A1> before using this command <2S>.
2. 10 different print area can be specified on one label.
3. Print speed and print darkness may be affected by dual color printing.
4. Barcode in dual color print area may result in lower scanner-readability.
5. Use print darkness grade E for command <#E>.
6. It is not possible to print in black within the area specified by the command <2S>.

[Tips]

1. The edge positions (2mm inside) may produce less clearness of dual color printing.
2. In case of 203dpi print head, the left and right block is divided at 4mm (32dots) inward to the left. (picture above)

12.19 System			
Available for	CT400/410/420	CT400-2/410-2/420-2	CT408/412/424i
<b>Offset</b>		<b>ESC+PO</b>	
Hexadecimal code	ESC <1B> <sub>16</sub>	PO <50> <sub>16</sub> <4F> <sub>16</sub>	Parameter abcc
Initial value	a=0,b=+,cc=00		
Persistence of the command	When printer is powered off	Set parameter will not be retained	
	Validity in a job	Retained until next valid setting	
	Validity after a job	Retained until next valid setting	

[Function]

Gives offset to media's stop position on the fly.

[Format]

<PO>abcc

•Parameter

a	Offset	=	0	:	Cutter
			1	:	Dispenser
			2	:	Tear-off
			3	:	Continuous
b	Offset direction	=	+	:	Feedforward
			-	:	Backward
c	Amount of offset	=	Valid range	:	00 to 99 (dots)

[Coding Example]

<A>

<PO>3+08

<Z>

[Notes]

1. Use potentiometer on the printer for permanent setting.
2. The setting is normally not needed.
3. The command is to fine-tune media position when it is required by specific application.

[Tips]

1. The setting is normally not necessary. Use potentiometer on the printer.

12.20 System			
Available for	CT400/410/420	CT400-2/410-2/420-2	CT408/412/424
<b>Change sensor type</b>		<b>ESC+IG</b>	
Hexadecimal code	ESC <1B> <sub>16</sub>	IG <49> <sub>16</sub> <47> <sub>16</sub>	Parameter a
Initial value	a=0		
Persistence of the command	When printer is powered off	Set parameter will not be retained	
	Validity in a job	Retained until next valid setting	
	Validity after a job	Retained until next valid setting	

[Function]

Changes sensor type on the fly

[Format]

<IG>a

•Parameter

a	Sensor type	=	0	:	Reflective (I-Mark)
			1	:	Transmissive (Gap)
			2	:	Sensor disabled

[Coding Example]

<A>

<IG>0

<Z>

[Notes]

1. The setting by this command is normally not needed.
2. The setting is valid until the printer is powered off. Printer's internal setting becomes valid at next power-up.



12.21 System			
Available for	CT400/410/420	CT400-2/410-2/420-2	CT408/412/424
<b>Change print method</b>		<b>ESC+PH</b>	
Hexadecimal code	ESC <1B> <sub>16</sub>	PH <50> <sub>16</sub> <48> <sub>16</sub>	Parameter a
Initial value	a=0		
Persistence of the command	When printer is powered off	Set parameter will not be retained	
	Validity in a job	Retained until next valid setting	
	Validity after a job	Retained until next valid setting	

[Function]

Changes print method on the fly

[Format]

<PH>a

•Parameter

a	Print method	=	0	:	Thermal transfer
			1	:	Direct Thermal

[Coding Example]

<A>

<PH>0

<Z>

[Notes]

1. The setting by this command is normally not needed.
2. The setting will be valid until the printer is powered off. At next power up, printer's internal setting will become valid.

12.22 System			
Available for	CT400/410/420	CT400-2/410-2/420-2	CT408/412/424i
<b>Paper handling mode</b>		<b>ESC+PM</b>	
Hexadecimal code	ESC <1B> <sub>16</sub>	PM <50> <sub>16</sub> <4D> <sub>16</sub>	Parameter a
Initial value	a=0		
Persistence of the command	When printer is powered off	Set parameter will not be retained	
	Validity in a job	Retained until next valid setting	
	Validity after a job	Retained until next valid setting	

[Function]

Select paper handling mode on the fly

[Format]

<PM>a

•Parameter

a	Paper handling	=	0	:	Continuous
			1	:	Tear-off
			2	:	Cutter (back feed after print)
			3	:	Cutter (back feed before print)
			4	:	Cutter (without back feed)
			5	:	Linerless media (back feed after print)
			6	:	Linerless media (without back feed)
			7	:	Dispenser (back feed after print)
			8	:	Dispenser (back feed before print)

The followings is only valid for CT400i (type 1/2)  
 9: Partial cut (Cutter position + cut during printing)  
 A: Partial cut (without backfeed)  
 B: Cutter (Cutter position + cut during printing)

[Coding Example]

<A>  
<PM>0  
 <Z>

[Notes]

1. Use DIP Switch on printer for permanent selection.
2. The selection by this command is only valid until printer is powered off. Printer's internal setting becomes valid at next power up.
3. The selection shall be consistent with DIP Switch setting.  
 In case the optional cutter is selected as main paper handling device (by DIP Switch), selection 2,3,4, above are valid, while 1,5,6,7,8 are invalid.

General description of each mode :

(1) Tear-off

The media will be fed up to the tear-off edge after being printed. Then the printer, after receiving next print data, will back feed the next label to the print head position.

(2) Cutter (Back feed after print)

The printer back feed the label up to the print head position immediately after the last label is cut.

(3) Cutter (Back feed before print)

The printer, after receiving the next print data, will back feed the media to the print head position.

(4) Cutter (without back feed)

No back feed.

(5) Linerless media (Back feed after print)

The printer back feed the label up to the print head position immediately after the last label is cut.

(6) Linerless media (without back feed)

No back feed.

(7) Dispenser (Back feed after print)

The printer back feed the label up to the print head position immediately after the last label is dispensed.

(8) Dispenser (Back feed before print)

The printer, after receiving the next print data, will back feed the media to the print head position.

12.23 System			
Available for	CT400/410/420	CT400-2/410-2/420-2	CT408/412/424i
<b>Media selection</b>		<b>ESC+YE</b>	
Hexadecimal code	ESC <1B> <sub>16</sub>	YE <59> <sub>16</sub> <45> <sub>16</sub>	Parameter a
Initial value	a=0		
Persistence of the command	When printer is powered off	Set parameter will not be retained	
	Validity in a job	Retained until next valid setting	
	Validity after a job	Retained until next valid setting	

[Function]

Changes media selection on the fly

[Format]

<YE>a

•Parameter

a	Select media	=	0	:	Self adhesive media
			1	:	Non adhesive media (Tag etc.)

[Coding Example]

<A>

<YE>0

<Z>

[Note]

1. The command is useful when the media type should be changed on the fly for now. Use command <PG>, or <PC> to change the media type selected for regular use.

12.24 System			
Available for	CT400/410/420	CT400-Z/410-Z/420-2	CT408/412/424
<b>Control code selection</b>		<b>ESC+CO</b>	
Hexadecimal code	ESC <1B> <sub>16</sub>	CO <43> <sub>16</sub> <4F> <sub>16</sub>	Parameter a
Initial value	a=0		
Persistence of the command	When printer is powered off	Set Parameter will be retained	
	Validity in a job	Retained until next valid setting	
	Validity after a job	Retained until next valid setting	

[Function]

Control code selection (Standard/Non-standard)

[Format]

<CO>a

•Parameter

a Control code = 0: Standard  
1: Non-standard

[Coding Example]

<A>  
<CO>1  
<Z>

[Notes]

1. Place this command between <A>start code and <Z>stop code.
2. This command may not be used in combination with other commands.
3. Selection can be confirmed by test print after the command <LD>(user download) is executed.
4. Repower the printer to make the selection valid.
5. In case of CT-Series printer, the same selection is available by commands<PG>or<PC>.

12.25 System				
Available for	CT400/410/420		CT400-2/410-2/420-2	
				CT408i/412i/424i
Arbitrary cut			ESC+CX	
Hexadecimal code	ESC <1B> <sub>16</sub>	CX <43> <sub>16</sub> <58> <sub>16</sub>	Parameter a	
Initial value	a=0			
Persistence of the command	When printer is powered off	Setting will not be retained		
	Validity in a job	Becomes invalid after execution		
	Validity after a job	Becomes invalid after the job		

[Function]  
Cut in arbitrary position

[Format]  
<CX>a  
 ●Parameter  
 a Cutting                      0 : Normal cutting  
                                          1 : Partial cutting

[Coding Example]  
<A>  
<CX>0  
<Z>

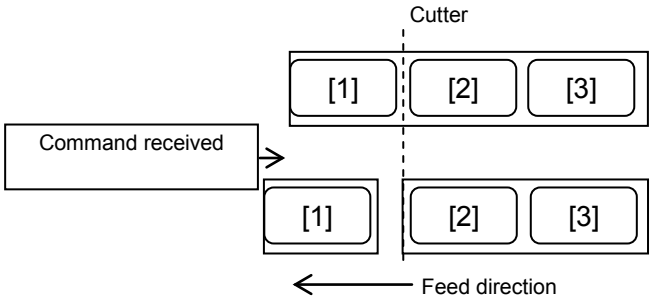

- [Notes]
1. The command is valid only for the printer with a cutter.
  2. The command is valid in cutter operation and partial cut operation modes only.
  3. The command execute cutting in arbitrary position.
  4. Place this command between <A>Start code and <Z>Stop code.
  5. The command may not be used in combination with other commands.
  6. The command is valid when the label is fed to cut position by command <IK>

12.26 System			
Available for	CT400/410/420	CT400-2/410-2/420-2	CT408i/412i/424i
<b>Media feed/back feed distance</b>		<b>ESC+IK</b>	
Hexadecimal code	ESC <1B> <sub>16</sub>	IK <49> <sub>16</sub> <4B> <sub>16</sub>	Parameter a,(bbbb)
Initial value	NIL		
Persistence of the command	When printer is powered off	Set parameter will not be retained	
	Validity in a job	Becomes invalid after execution	
	Validity after a job	Becomes invalid after the job	

[Function]

Feed or back feed the media by the specified distance

[Format]

<IK>a,bbbb

•Parameter

- a Feed direction = 0 : Feed distance by number of dots specified  
1 : Back feed distance by number of dots specified
- b Feed distance = Refer to "Note" below for valid range

<IK>a

•Parameter

- a Feed direction = 0 : Feed by one complete label  
2 : Feed from PH position to tear-off edge  
3 : Back feed from tear-off edge to PH position  
4 : Feed from PH position to cutting position  
5 : Back feed from cutting position to PH position

[Coding Example 1] Feed by 120 dots

<A>  
<IK>0,120  
<Z>

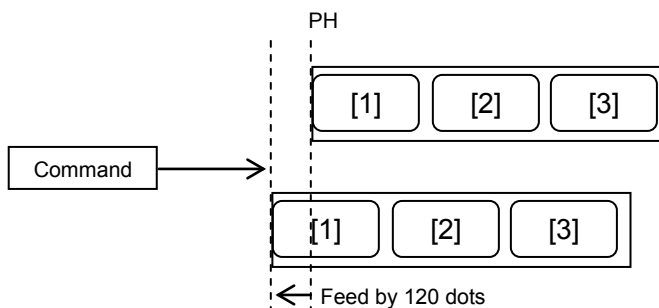

[Coding Example 2] Feed by one complete label

<A>  
<IK>0  
<Z>

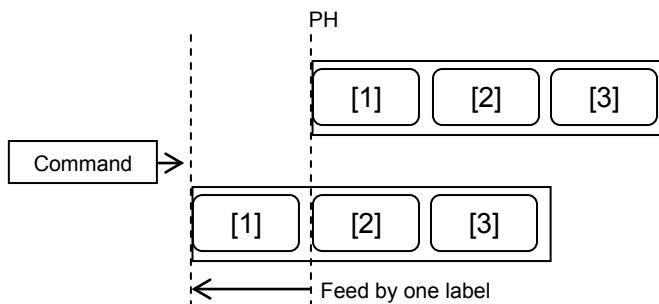

[Coding Example 3] Forward feed to tear-off position

<A>  
<IK>2  
 <Z>

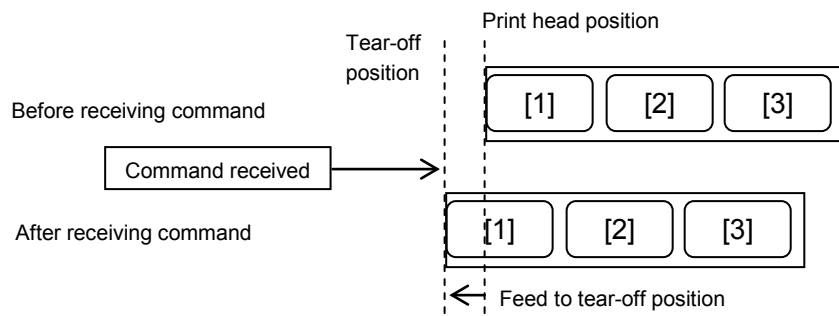

If receiving the print data without going back to the original position by the command <IK>3, printing operation will start from the currently stopped position.

[Coding Example 4] Backfeed from tear-off position to print head position

<A>  
<IK>3  
 <Z>

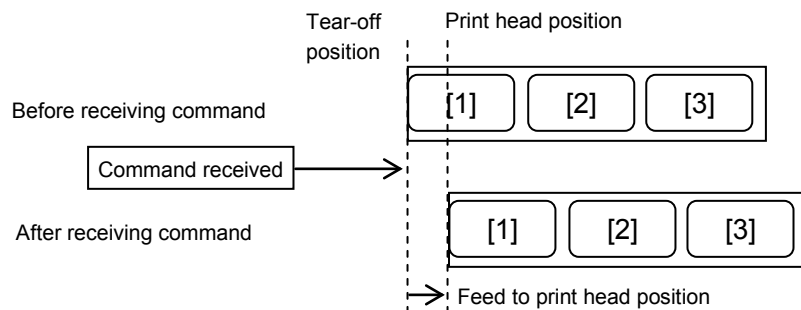

[Coding Example 5] Forward feed to cutter position

<A>  
<IK>4  
 <Z>

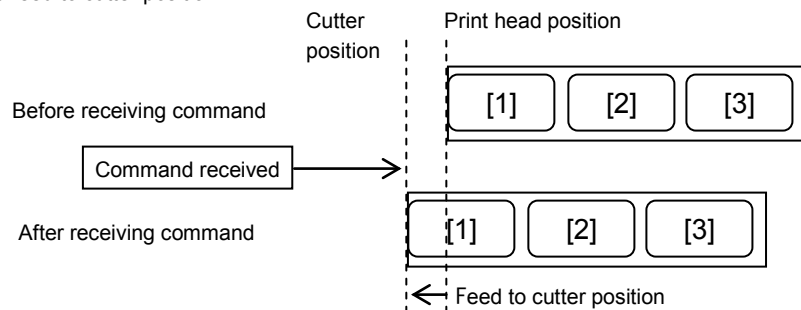

If receiving the print data without going back to the original position by the command <IK>5, printing operation will start from the currently stopped position.

[Coding Example 6] Backfeed from cutter position to print head position

<A>  
<IK>5  
 <Z>

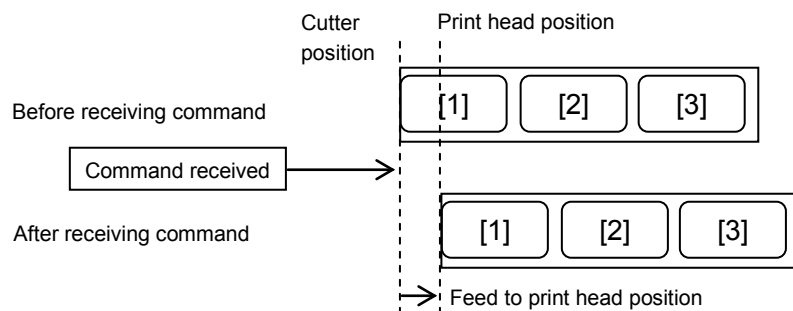

[Notes]

1. Place this command between <A> Start code and <Z> Stop code.  
This command is invalid when being specified in the item together with the print data.
2. Setting the label feed direction to backfeed will give a longer label feed distance. Consequently, the label may get loose and slip from the platen. In such case, it may be detected as paper end. Also in the backfeed distance to tear-off position and cutter position, make sure to keep the label on the platen.
3. Do not perform label backfeed as soon as the label is cut off or dispensed in Cutter Mode and Dispense Mode.
4. If not specifying the feed distance in forward feed motion, its behavior will be the same as that of label feed motion when pressing the FEED key in offline state.
5. Label feed motion by this command will be activated when in online state.
6. If not specifying the feed distance in backfeed motion, the label will not be fed due to a command error.
7. When the sensor is disabled in Continuous Mode, the label will not be fed by <IK>0 (Label feed distance omitted).
8. When the specified feed distance is other than the valid range, the label will not be fed due to a command error.

[Valid range]

Head density	Valid range (dot)
8 dots/mm	48 to 1600
12 dots/mm	72 to 2400
23.6 dots/mm	144 to 4800





12.28 System			
Available for	CT400/410/420	CT400-2/410-2/420-2	CT408i/412i/424i
<b>Serial interface setting</b>		<b>ESC+I2</b>	
Hexadecimal code	ESC <1B> <sub>16</sub>	I2 <49> <sub>16</sub> <32> <sub>16</sub>	Parameter abcde
Initial value	a=1,b=0,c=0,d=0,e=1		
Persistence of the command	When printer is powered off	Set parameter will be retained	
	Validity in a job	Becomes invalid after execution	
	Validity after a job	Becomes invalid after the job	

[Function]

Serial Interface setting

[Format]

<I2>abcde

•Parameter

a	Baud rate	:	0 = 9600bps 1 = 19200bps 2 = 38400bps 3 = 57600bps
b	Data bit	:	0 = 8bit 1 = 7bit
c	Parity	:	0 = No parity 1 = Odd 2 = Even
d	Stop bit	:	0 = 1bit 1 = 2bit
e	Control	:	0 = READY/BUSY control (Single item buffer) 1 = READY/BUSY control (Multi item buffer) 2 = XON/XOFF 3 = Driver protocol 4 = Status 3

[Coding Example]

<A>

**<I2>10003**

<Z>

[Notes]

1. If your CT printer has a RS-232C board with DIP Switches, and priority is set to DIP Switch for serial interface, only two types of control can be selectable: READY/BUSY control (Single item buffer) / READY/BUSY control (Multi-item buffer).
2. The setting of this command is valid after a restart.

12.29 System			
Available for	CT400/410/420	CT400-2/410-2/420-2	CT408i/412i/424i
<b>LAN interface setting</b>		<b>ESC+I3</b>	
Hexadecimal code	ESC <1B> <sub>16</sub>	I3 <49> <sub>16</sub> <33> <sub>16</sub>	Parameter a
Initial value	a=0		
Persistence of the command	When printer is powered off	Set parameter will be retained.	
	Validity in a job	Becomes invalid after execution	
	Validity after a job	Becomes invalid after the job	

[Function]

LAN Interface setting

[Format]

<I3>a

•Parameter

a LAN Mode = 0 : 2 port connection/unsolicited (for driver protocol)  
 1 : 2 port connection /solicited by ENQ (for driver protocol)  
 2 : 1 port connection /solicited by ENQ (STATUS3)

[Coding Example]

<A>

<I3>0

<Z>

[Note]

1. The setting of this command is valid after a restart.

12.30 System			
Available for	CT400/410/420	CT400-2/410-2/420-2	CT408i/412i/424i
<b>PIN code setting</b>		<b>ESC+I6</b>	
Hexadecimal code	ESC <1B> <sub>16</sub>	I6 <49> <sub>16</sub> <36> <sub>16</sub>	Parameter a~a
Initial value	a~a=0000000000000000		
Persistence of the command	When printer is powered off	Set Parameter will be retained	
	Validity in a job	Becomes invalid after execution	
	Validity after a job	Becomes invalid after the job	

[Function]

PIN code setting

[Format]

<I6>a~a

•Parameter

a PIN Code setting = 16 digit ASCII (20H ~ 7EH) excluding control code

[Coding Example]

<A>

**<I6>1234567890123456**

<Z>

[Notes]

1. This command is available for CT400i(Type1) with Bluetooth interface.
2. Place this command between <A>start code and <Z> stop code.  
This command may not be used in combination with other commands.
3. PIN Code can be printed on the factory test print.
4. Number of digit for PIN code may vary from 1 to 16. Longer PIN code will result in command error and the PIN code will not be registered.
5. Repower the printer to make the PIN code setting valid.
6. Default setting

PIN code	0000000000000000
----------	------------------

7. Do not power off the printer until the new setting is completely stored in the printer memory and you hear an audible signal at completion.

12.31 System			
Available for	CT400/410/420	CT400-2/410-2/420-2	CT408i/412i/424i
<b>Authentication mode (Bluetooth)</b>		<b>ESC+I7</b>	
Hexadecimal code	ESC <1B> <sub>16</sub>	I7 <49> <sub>16</sub> <37> <sub>16</sub>	Parameter abbbbccccddddeeee
Initial value	a=0,bbbb=0800,cccc=0012,dddd=0800,eeee=0012		
Persistence of the command	When printer is powered off		Set Parameter will be retained
	Validity in a job		Becomes invalid after execution
	Validity after a job		Becomes invalid after the job

[Function]

Selects authentication mode of Bluetooth and specify parameters for search and connection

[Format]

<I7>abbbbccccddddeeee

[Parameter]

- a Authentication mode = 0 : Level1 (No PIN authentication) 1digit fixed  
1 : Level2-1  
2 : Level2-2  
3 : Level3
- b [ISI] = Valid range :0015 to 1000 (4digits HEX)
- c [ISW] = Valid range :0012 to 0997 (4digits HEX)
- d [PSI] = Valid range :0015 to 1000 (4digits HEX)
- e [PSW] = Valid range :0012 to 0997 (4digits HEX)

[Coding Example]

<A>  
**<I7>00800010008000036**  
 <Z>

[Notes]

- This command is available for CT400i(Type1) with Bluetooth interface.
- Place this command between <A>start code and <Z> stop code.  
This command may not be used in combination with other commands.
- PIN code setting can be printed on the factory test print.
- If Level1(No PIN authentication) is selected, make sure to set host setting also to "No authentication".
- Repower the printer to make the setting valid.
- Default setting

Authentication mode	0 (Level 1)
[ISI]	0800
[ISW]	0012
[PSI]	0800
[PSW]	0012

- Do not power off the printer until the new setting is completely stored in the printer memory and you hear an audible signal at completion.

12.32 System			
Available for	CT400/410/420	CT400-2/410-2/420-2	CT408i/412i/424i
Device name		ESC+I8	
Hexadecimal code	ESC <1B> <sub>16</sub>	I8 <49> <sub>16</sub> <38> <sub>16</sub>	Parameter a~a
Initial value	a~a=SATO ONLINE PRINTER		
Persistence of the command	When printer is powered off	Set Parameter will be retained	
	Validity in a job	Becomes invalid after execution	
	Validity after a job	Becomes invalid after the job	

[Function]

Specify Device name

[Format]

<I8>a~a

[Parameter]

a Device name = ASCII (20H ~ 7EH) Excluding control code characters  
1 to 20digits

[Coding Example]

<A>  
**<I8>PRINTER No.1**  
<Z>

[Notes]

1. This command is available for CT400i(Type1) with Bluetooth interface.
2. Place this command between <A>start code and <Z> stop code.  
This command may not be used in combination with other commands.
3. Device name
4. The length of the name may vary from 1digit to 20digits. Invalid length (over 20digits) will result in a command error and the name will not be registered.
5. Repower the printer to make the setting valid.
6. Default setting

Device name	SATO ONLINE PRINTER
-------------	---------------------

7. Do not power off the printer until the new setting is completely stored in the printer memory and you hear an audible signal at completion.

12.33 System			
Available for	CT400/410/420	CT400-2/410-2/420-2	CT408i/412i/424i
<b>Bluetooth setting</b>		<b>ESC+BS</b>	
Hexadecimal code	ESC <1B> <sub>16</sub>	BS <42> <sub>16</sub> <53> <sub>16</sub>	Parameter a
Initial value	a=0		
Persistence of the command	When printer is powered off	Set Parameter will be retained	
	Validity in a job	Retained until next valid setting	
	Validity after a job	Retained until next valid setting	

[Function]

Bluetooth mode setting

[Format]

<BS>a

•Parameter

a Bluetooth mode = 0 : Status 4  
1 : Status 3

[Coding Example]

<A>  
<BS>0  
<Z>

[Notes]

1. This command is available for CT400i(Type1) with Bluetooth interface.
2. Place this command between <A>start code and <Z> stop code.
3. This command may not be used in combination with other commands.
4. Setting can be printed on the factory test print.
5. Repower the printer to make the setting valid.

12.34 System			
Available for	CT400/410/420	CT400-2/410-2/420-2	CT408i/412i/424i
<b>IP address setting</b>		<b>ESC+W1</b>	
Hexadecimal code	ESC <1B> <sub>16</sub>	W1 <57> <sub>16</sub> <31> <sub>16</sub>	Parameter a~a
Initial value	a~a=000000000000		
Persistence of the command	When printer is powered off	Set Parameter will be retained	
	Validity in a job	Becomes invalid after execution	
	Validity after a job	Becomes invalid after the job	

[Function]

IP address setting

[Format]

<W1>a~a

•Parameter

a~a            IP address            = 12-digit number

[Coding Example]

<A>

**<W1>123220000040**

<Z>

[Notes]

1. This command is available for CT400i(Type2) with LAN interface.
2. Place this command between <A>start code and <Z> stop code.
3. This command may not be used in combination with other commands.
4. Setting can be printed on the factory test print.
5. Repower the printer to make the setting valid.
6. Default setting

IP address	000000000000
------------	--------------



12.35 System			
Available for	CT400/410/420	CT400-2/410-2/420-2	CT408i/412i/424i
<b>Subnet mask setting</b>		<b>ESC+W2</b>	
Hexadecimal code	ESC	W2	Parameter
	<1B> <sub>16</sub>	<57> <sub>16</sub> <32> <sub>16</sub>	a~a
Initial value	a~a=000000000000		
Persistence of the command	When printer is powered off	Set Parameter will be retained	
	Validity in a job	Becomes invalid after execution	
	Validity after a job	Becomes invalid after the job	

[Function]

Subnet mask setting

[Format]

<W2>a~a

•Parameter

a~a Subnet mask = 12-digit number

[Coding Example]

<A>

**<W2>255255255000**

<Z>

[Notes]

1. This command is available for CT400i(Type2) with LAN interface.
2. Place this command between <A>start code and <Z> stop code.
3. This command may not be used in combination with other commands.
4. Setting can be printed on the factory test print.
5. Repower the printer to make the setting valid.
6. Default setting

Subnet mask	000000000000
-------------	--------------

12.36 System			
Available for	CT400/410/420	CT400-2/410-2/420-2	CT408i/412i/424i
<b>Default gateway setting</b>		<b>ESC+W3</b>	
Hexadecimal code	ESC <1B> <sub>16</sub>	W3 <57> <sub>16</sub> <33> <sub>16</sub>	Parameter a~a
Initial value	a~a=000000000000		
Persistence of the command	When printer is powered off	Set Parameter will be retained	
	Validity in a job	Becomes invalid after execution	
	Validity after a job	Becomes invalid after the job	

[Function]

Default gateway setting

[Format]

<W3>a~a

•Parameter

a~a      Default gateway      =    12-digit number

[Coding Example]

<A>

**<W3>128220001001**

<Z>

[Notes]

1. This command is available for CT400i(Type2) with LAN interface.
2. Place this command between <A>start code and <Z> stop code.
3. This command may not be used in combination with other commands.
4. Setting can be printed on the factory test print.
5. Repower the printer to make the setting valid.
6. Default setting.

Default gateway	000000000000
-----------------	--------------

[Important]

Use the valid subnet address (=consistent to the IP address currently used) for the default gateway.

12.37 System			
Available for	CT400/410/420	CT400-2/410-2/420-2	CT408i/412i/424i
<b>IP address setting</b>		<b>ESC+WI</b>	
Hexadecimal code	ESC <1B> <sub>16</sub>	WI <57> <sub>16</sub> <49> <sub>16</sub>	Parameter a
Initial value	a=1		
Persistence of the command	When printer is powered off	Set Parameter will be retained	
	Validity in a job	Becomes invalid after execution	
	Validity after a job	Becomes invalid after the job	

[Function]

Selects IP address setting method.

[Format]

<WI>a

•Parameter

a IP address setting = 0 : Manual setting  
1 : by DHCP

[Coding Example]

<A>  
<WI>1  
<Z>

[Notes]

1. This command is available for CT400i(Type2) with LAN interface.
2. Place this command between <A>start code and <Z>stop code.
3. This command may not be used in combination with other commands.
4. Setting can be printed on the factory test print.
5. Repower the printer to make the setting valid.
6. Default setting.

IP address setting	1 (by DHCP)
--------------------	-------------

12.38 System			
Available for	CT400/410/420	CT400-2/410-2/420-2	CT408i/412i/424i
<b>RARP setting</b>		<b>ESC+WM</b>	
Hexadecimal code	ESC <1B> <sub>16</sub>	WM <57> <sub>16</sub> <4D> <sub>16</sub>	Parameter a
Initial value	a=1		
Persistence of the command	When printer is powered off	Set Parameter will be retained	
	Validity in a job	Becomes invalid after execution	
	Validity after a job	Becomes invalid after the job	

[Function]

RARP Setting. When enabled, RARP will automatically take IP address.

[Format]

<WM>a

•Parameter

a RARP setting = 0 : Disabled  
1 : Enabled

[Coding Example]

<A>  
<WM>1  
<Z>

[Notes]

1. This command is valid for CT400i(Type2) with LAN interface.
2. Place this command between <A>start code and <Z>stop code.
3. This command may not be used in combination with other commands.
4. Setting can be printed on the factory test print.
5. Repower the printer to make the setting valid.
6. Default.

IP Address	1 (RARP Enabled)
------------	------------------



12.40 System			
Applicable for			
	CT400/410/420	CT400-2/410-2/420-2	CT408i/412i/424i
<b>Option waiting time</b>		<b>ESC+TW</b>	
Hex code	ESC	TW	Parameter
	<1B> <sub>16</sub>	<54> <sub>16</sub> <57> <sub>16</sub>	Aaa
Default setting	aaa = 010(1000ms)		
Persistence of the command	When printer is powered off		Set parameter will be retained
	Validity in a job		Retained until next valid setting
	Validity after a job		Retained until next valid setting

[Function]

Specifies waiting time for option operations

[Format]

<TW>aaa

●Parameter

aaa [Waiting time for option operation] = Valid range: 005 to 200 (unit: 100ms)

[Coding example] (Waiting time for option operation = 1.5 seconds)

<A>

**<TW>015**

<Z>

[Notes]

1. This command specifies, in Tear-off mode, the waiting time between print completion and Tear-off motion.
2. The set parameter becomes valid soon after receiving the command and will be retained after power off.
3. The waiting time to perform cutting after print is only valid for operation mode 4.

12.41 System			
Applicable for			
	CT400/410/420	CT400-2/410-2/420-2	CT408i/412i/424i
<b>Forced Tear off</b>		<b>ESC+TK</b>	
Hex code	ESC	TK	Parameter
	<1B> <sub>16</sub>	<54> <sub>16</sub> <4B> <sub>16</sub>	None
Default setting	None		
Persistence of the command	When printer is powered off		Set parameter will be retained
	Validity in a job		Retained until next valid setting
	Validity after a job		Retained until next valid setting

[Function]

Executes Tear off compulsory

[Format]

<TK>

[Coding example]

<A>

<TK>

<Z>

[Notes]

1. This command can be specified only in Tear off mode.
2. With this command, the printer executes Tear off motion without waiting the time set by command <TW>. If the next data is received before Tear off motion, Tear off is executed compulsory.
3. This command can not be used in combination with other commands.  
Do not send this command in a row.

[Tips]

1. This command can be used to save the time set by command <TW>, if it is sure that there is no following item.

12.42 System			
Applicable for			
	CT400/410/420	CT400-2/410-2/420-2	CT408i/412i/424i
<b>Battery mode</b>		<b>ESC+TB</b>	
Hex code	ESC	TB	Parameter
	<1B> <sub>16</sub>	<54> <sub>16</sub> <42> <sub>16</sub>	a
Default setting	a=0		
Persistence of the command	When printer is powered off		Set parameter will be retained
	Validity in a job		Becomes invalid after execution
	Validity after a job		Becomes invalid after the job

[Function]

Specifies battery operation mode

[Format]

<TB>a

●Parameter

a [Operation mode] = 0: Normal operation  
1: Battery operation

[Coding example]

<A>

**<TB>1**

<Z>

[Notes]

1. When this command is sent, the printer sounds buzzer 3 times and any operations will be rejected. Restart the printer to make the setting effective. If the printer is set to Battery mode, it starts to check the battery voltage. The battery voltage is not checked in normal operation mode.
2. If the printer is powered by AC in Battery mode, throughput will be lowered due to the battery check conducted page by page.
3. If the printer is powered by battery in Normal mode, due to no battery check, malfunction may occur when the battery is low.
4. Normal operation mode is available after entering Operation setup mode (Pressing FEED/LINE key + POWER ON and release the key after ONLINE LED (Green) blinks), select default settings and restart the printer.

(\*1) When operation mode is changed by this command, the printer sounds buzzer 3 times and stops to its operation. If the mode is not changed, no buzzer sounds and you can use the printer continuously.





Extensive contact information of worldwide SATO operations can be found on the Internet at <http://www.satoworldwide.com>